

Probe Pin Solderless Compression Test Socket

For CGA / PGA / PGI Package

0.40 mm pitch (from 0.40 mm to 0.49 mm)

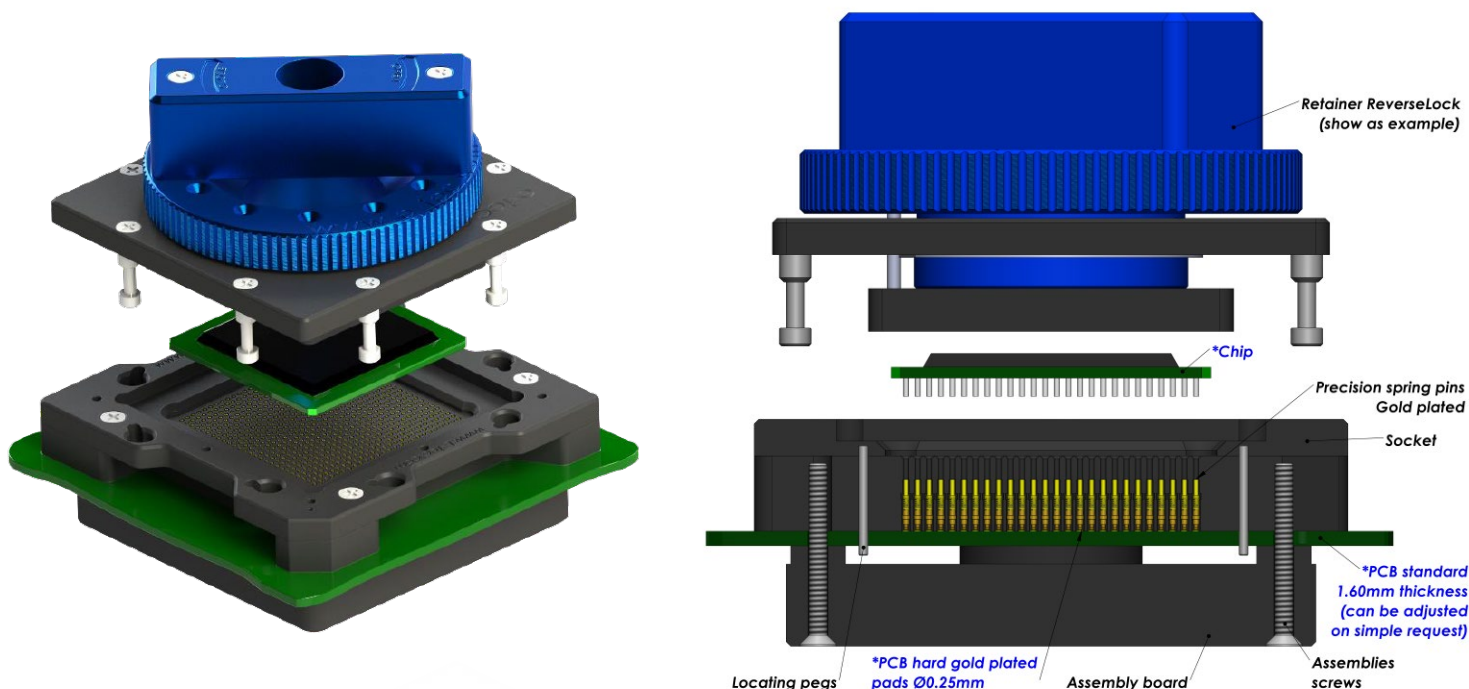
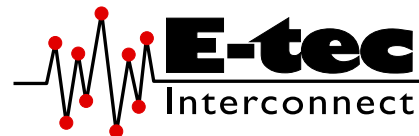

E-tec Interconnect AG is the world leading Test socket manufacturer

Probe Pin (Pogo) Solderless compression Test Sockets type are available for any chip size and pitch and are attached with 2, 4 or 8 screws to the PCB. The assembly board ensures perfect coplanarity of the socket. Contact reliability is guaranteed with spring loaded gold plated contacts, which are pressed onto gold plated PCB pads. Probe Pin (Pogo) Solderless compression type sockets are available with all retention systems. We aim to solve your requirements. Please note, we will always request the chip data to ensure we offer a compatible socket.

Contacts Specifications				
Contact type code	0490	0491	0492	0494
Application	Standard	Frequency	High Frequency	High Power
Mounting	Solderless	Solderless	Solderless	Solderless
Bandwidth (GHz@-1dB)	3 GHz	10 GHz	20 GHz	na
Contact resistance	<100 mOhm	100 mOhm	100 mOhm	100 mOhm
Chip contact tip shape	Single Point tip	Single Point tip	Single Point tip	Crown tip
PCB tip shape	Spring	Single Point tip	Single Point tip	Single Point tip
Force	20 gr	20 gr	20 gr	30 gr
Current rating	0.5 A	1.5 A	1.5 A	3 A
Capacitance pF	<1pF	0.90 pF	0.50 pF	na
Inductance nH	<2nH	1.50 nH	1.20 nH	na
Impedance Ohms	45 Ω	48 Ω	42 Ω	na
Temperature range	-55°C to +150°C	-40°C to +120°C	-40°C to +120°C	-40°C to +120°C
Mating cycles	100 K	300 K	100 K	100 K

More on the next page



Probe Pin Solderless Compression Test Socket

For CGA / PGA / PGI Package

0.40 mm pitch (from 0.40 mm to 0.49 mm)

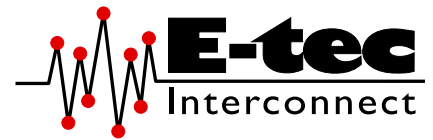

Standard assembly boards

Small Chip size



Medium Chip size

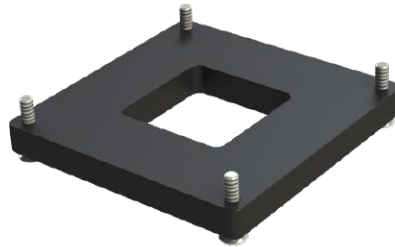

Large Chip size



Custom assembly boards

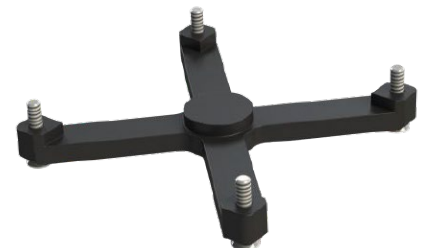
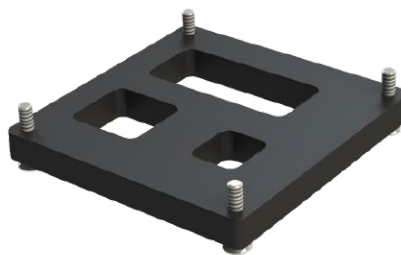
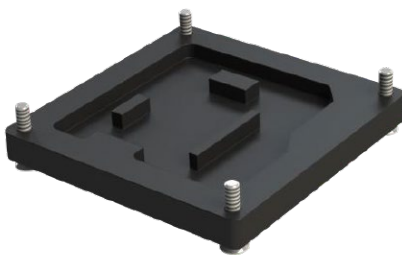

How to order

CP # # # # # -049# - # # # # # # 55L #

<p>Shape of tip</p> <p>P : Pointed</p>	<p>Nbr of contacts</p> <p>Depends on ballcount of chip</p>	<p>Contact type</p> <p>91 to 94 : See "Contacts specification" chart 90 : Standard solderless compression style 9M : Special mixed contact style</p>	<p>Plating</p> <p>55L: Gold + Locating pegs Other on request</p>	<p>Option code (see page 16-19)</p> <p>D : Dead bug M : Multi frames U : Multi packages C : Converter plate S : Custom opening slot H : Heatsink F : Fan + Heatsink P : Thermal drain pad W : Transparent lid I : Steel retention lid B : Aluminium retention lid T : Torque tool fixture G : Handling button</p>
<p>Retention frame type (Lid) (see page 12-15)</p> <p>W: TwistLock F : FastLock B : SpringLock H : Open Clamshell Alu (<200 contacts) J : Clamshell Alu (>200 contacts) L : Open Lever Clamshell Alu (>200 contacts)</p>		<p>S : ScrewLock Q : Open QuickLock (<200 contacts) D : QuickLock (>200 contacts) M : Injection Molded ClamShell R : ReverseLock T : SlimLock</p>	<p>Grid code / Config. code</p> <p>Will be given by the factory after receipt of the chip datasheet</p>	

