

Probe Pin Solderless Compression Test Socket

For LGA / QFN / MLF / MLP / LCC Package

1.27 mm pitch (from 1.27 mm upwards)

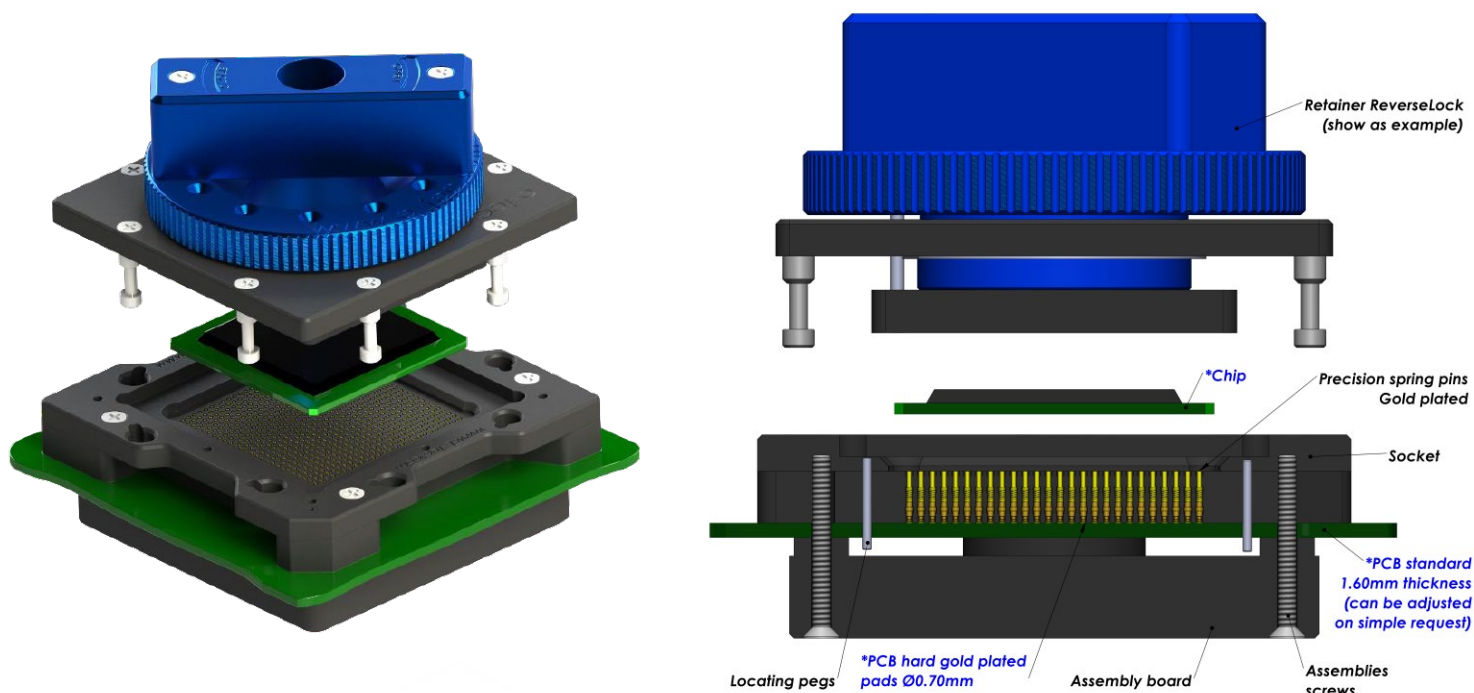
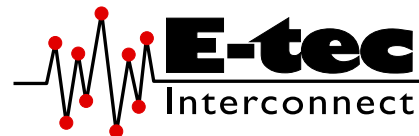

E-tec Interconnect AG is the world leading Test socket manufacturer

Probe Pin (Pogo) Solderless compression Test Sockets type are available for any chip size and pitch and are attached with 2, 4 or 8 screws to the PCB. The assembly board ensures perfect coplanarity of the socket. Contact reliability is guaranteed with spring loaded gold plated contacts, which are pressed onto gold plated PCB pads. Probe Pin (Pogo) Solderless compression type sockets are available with all retention systems. We aim to solve your requirements. Please note, we will always request the chip data to ensure we offer a compatible socket.

Contacts Specifications				
Contact type code	1290	1291	1294	1298
Application	Standard	High Frequency + Long Live	Frequency	Frequency
Mounting	Solderless	Solderless	Solderless	Solderless
Bandwidth (GHz@-1dB)	3 GHz	37.5 GHz	13.3 GHz	23.7 GHz
Contact resistance	<100 mOhm	45 mOhm	25 mOhm	25 mOhm
Chip contact tip shape	Single Point tip Concave tip	Crown tip	Single Point tip	Single Point tip
PCB tip shape	Single Point tip	Single Point tip	Spring	Spring
Force	25 gr	35 gr	25 gr	25 gr
Current rating	2.2 A	3 A	5 A	2.6 A
Capacitance pF	<1 pF	0.43 pF	0.76 pF	0.50 pF
Inductance nH	<2 nH	0.82 nH	1.73 nH	2.03 nH
Impedance Ohms	48 Ω	41 Ω	42.8 Ω	67.5 Ω
Temperature range	-55°C to +150°C	-40°C to +120°C	-55°C to +150°C	-55°C to +150°C
Mating cycles	100 K	300 K	100 K	100 K

More on the next page



Probe Pin Solderless Compression Test Socket

For LGA / QFN / MLF / MLP / LCC Package

1.27 mm pitch (from 1.27 mm upwards)

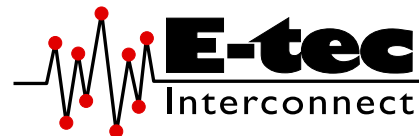

Standard assembly boards

Small Chip size



Medium Chip size

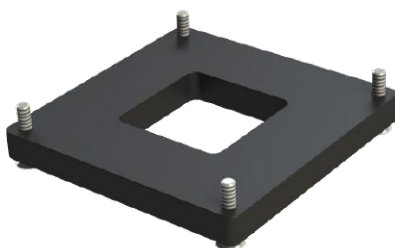

Large Chip size

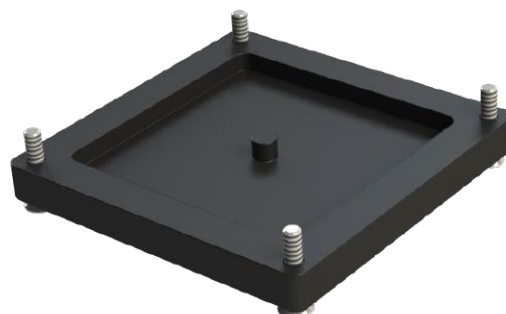

Custom assembly boards

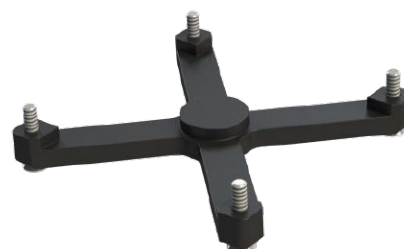
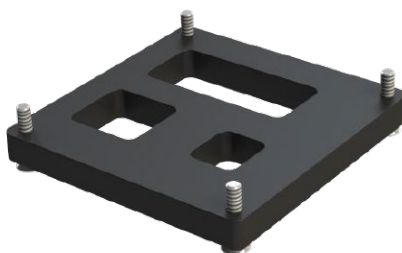
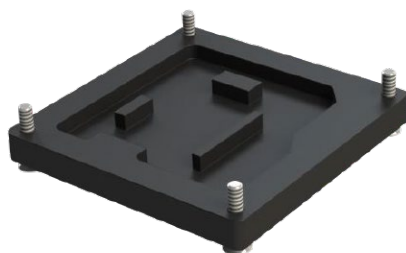

How to order

LP # # # # -129# - # # # # # 55L #

Shape of tip

P : Pointed

Options:

C : Crown

Nbr of contacts

Depends on ballcount of chip

Contact type

91 to 98 : See "Contacts specification" chart

90 : Standard solderless compression style

9M : Special mixed contact style

Plating

55L: Gold + Locating pegs

Other on request

Option code (see page 16-19)

D : Dead bug

M : Multi frames

U : Multi packages

C : Converter plate

S : Custom opening slot

H : Heatsink

F : Fan + Heatsink

P : Thermal drain pad

W : Transparent lid

I : Steel retention lid

B : Aluminium retention lid

T : Torque tool fixture

G : Handling button

Retention frame type (Lid) (see page 12-15)

W: TwistLock

F : FastLock

B : SpringLock

H : Open Clamshell Alu (<200 contacts)

J : Clamshell Alu (>200 contacts)

L : Open Lever Clamshell Alu (>200 contacts)

S : ScrewLock

Q : Open QuickLock (<200 contacts)

D : QuickLock (>200 contacts)

M : Injection Molded ClamShell

R : ReverseLock

T : SlimLock

Grid code / Config. code

Will be given by the factory after receipt of the chip datasheet

