

Elastomer Solderless Compression Test Socket

For LGA / QFN / MLF / MLP / LCC Package

0.80 mm pitch (from 0.80 mm to 0.99 mm)

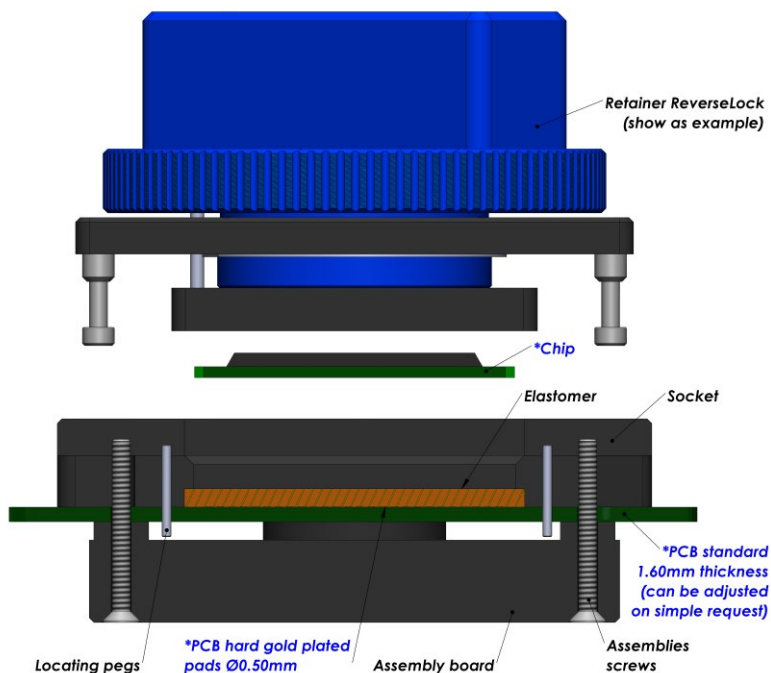
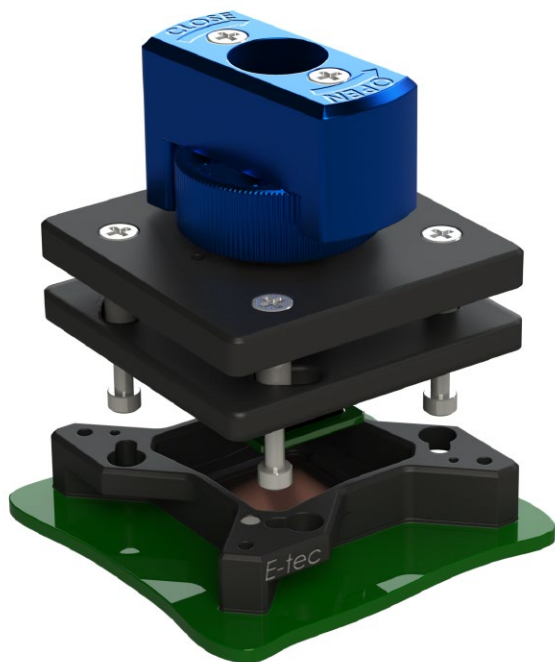
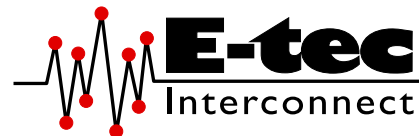

E-tec Interconnect AG is the world leading Test socket manufacturer

The Elastomer Solderless compression Test Sockets are ideal technical solution for good signal integrity with low signal loss. The sockets are available for any chip size and pitch and are attached with 2, 4 or 8 screws to the PCB. The socket outline will be kept to a minimum and special clearances can be offered to avoid components on the PCB.

SMT and thru-hole adapter sockets are available in certain pitches (contact factory for availability first) with these elastomer interposers to allow using this high frequency interposer on PCB's which have already been laid out for SMT or thru-hole sockets. We aim to solve your requirements. Please note, we will always request the chip data to ensure we offer a compatible socket.

Contacts Specifications		
Contact type code	E1	E2
Application	High Frequency	
Mounting	Solderless	Solderless
Bandwidth (GHz@-1dB)	23 GHz	24 GHz
Contact resistance	30 mOhm	
Chip contact tip shape	Gold Wire	
PCB tip shape	Gold Wire	
Force	20 gr to 50 gr	
Current rating	3 A	
Capacitance pF	0.26 pF	0.16 pF
Inductance nH	0.52 nH	0.26 nH
Impedance Ohms	44.8 Ω	44.4 Ω
Temperature range	-40°C to +125°C	
Mating cycles	1 K	

More on the next page



Elastomer Solderless Compression Test Socket

For LGA / QFN / MLF / MLP / LCC Package

0.80 mm pitch (from 0.80 mm to 0.99 mm)

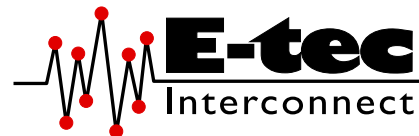

Standard assembly boards

Small Chip size



Medium Chip size

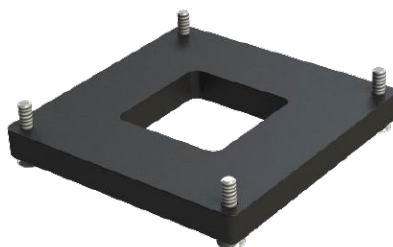

Large Chip size



Custom assembly boards

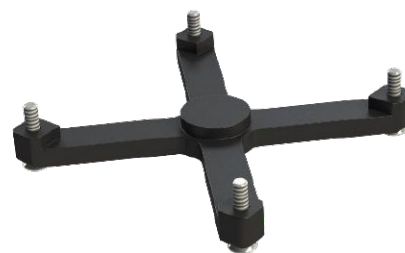
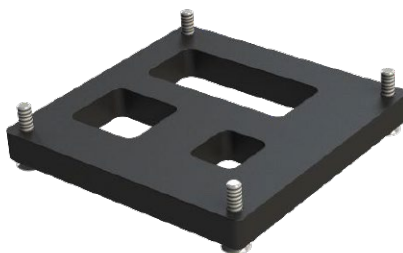
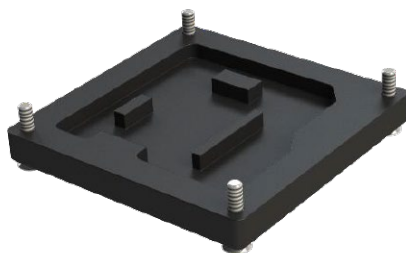

How to order

LE # #### -08E# - ##### 55L #

Shape of tip
E : Elastomer

Nbr of contacts
Depends on ballcount of chip

Contact type
E1 : High Frequency 23 GHz
E2 : High Frequency 24 GHz

Plating
55L: Gold + Locating pegs

Option code (see page 16-19)

- M : Multi frames
- U : Multi packages
- C : Converter plate
- S : Custom opening slot
- H : Heatsink
- F : Fan + Heatsink
- W : Transparent lid
- I : Steel retention lid
- B : Aluminium retention lid
- G : Handling button

Retention frame type (Lid) (see page 12-15)

- | | |
|--|------------------------------------|
| W : TwistLock | S : ScrewLock |
| F : FastLock | Q : Open QuickLock (<200 contacts) |
| B : SpringLock | D : QuickLock (>200 contacts) |
| H : Open Clamshell Alu (<200 contacts) | M : Injection Molded ClamShell |
| J : Clamshell Alu (>200 contacts) | R : ReverseLock |
| L : Open Lever Clamshell Alu (>200 contacts) | T : SlimLock |

Grid code / Config. code
Will be given by the factory after receipt of the chip datasheet

