

Probe Pin Solderless Compression Test Socket

For LGA / QFN / MLF / MLP / LCC Package

0.80 mm pitch (from 0.80 mm to 0.99 mm)

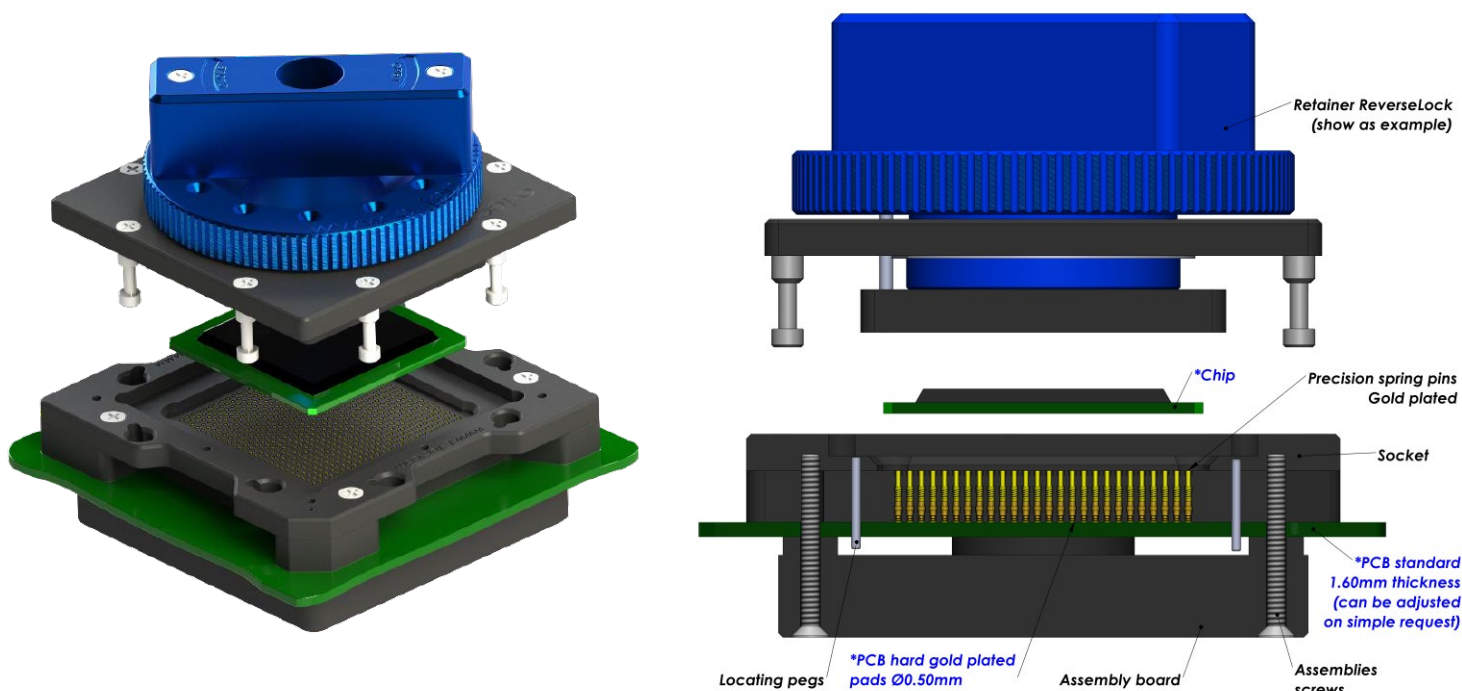
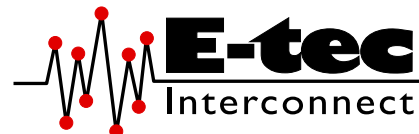

E-tec Interconnect AG is the world leading Test socket manufacturer

Probe Pin (Pogo) Solderless compression Test Sockets type are available for any chip size and pitch and are attached with 2, 4 or 8 screws to the PCB. The assembly board ensures perfect coplanarity of the socket. Contact reliability is guaranteed with spring loaded gold plated contacts, which are pressed onto gold plated PCB pads. Probe Pin (Pogo) Solderless compression type sockets are available with all retention systems. We aim to solve your requirements. Please note, we will always request the chip data to ensure we offer a compatible socket.

Contacts Specifications						
Contact type code	0890	0891	0893	0892	0894	0898
Application	Standard	High Frequency	Low Contact Resistance	High Frequency	Frequency	Frequency
Mounting	Solderless	Solderless	Solderless	Solderless	Solderless	Solderless
Bandwidth (GHz@-1dB)	3.4 GHz	36 GHz	7 GHz	31 GHz	14 GHz	31.7 GHz
Contact resistance	<100 mOhm	100 mOhm	40 mOhm	90 mOhm	90 mOhm	25 mOhm
Chip contact tip shape	Single Point tip Concave tip	Single Point tip	Crown tip	Single Point tip	Single Point tip	Single Point tip
PCB tip shape	Single Point tip	Single Point tip	Single Point tip	Spring	Spring	Spring
Force	30 gr	33 gr	23 gr	20 gr	20 gr	25 gr
Current rating	1.8 A	1 A	1 A	0.5 A	0.5 A	2.6 A
Capacitance pF	<1 pF	0.47 pF	0.55 pF	0.37 pF	0.30 pF	0.60 pF
Inductance nH	<2 nH	0.93 nH	1.08 nH	1.67 nH	1.66 nH	1.38 nH
Impedance Ohms	40 Ω	38 Ω	39 Ω	73 Ω	78 Ω	44.8 Ω
Temperature range	-55°C to +150°C	-40°C to +120°C	-50°C to +150°C	-55°C to +150°C	-55°C to +150°C	-55°C to +150°C
Mating cycles	100 K	100 K	100 K	100 K	100 K	100 K

More on the next page



Probe Pin Solderless Compression Test Socket

For LGA / QFN / MLF / MLP / LCC Package

0.80 mm pitch (from 0.80 mm to 0.99 mm)

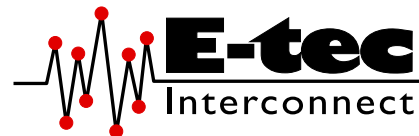

Standard assembly boards

Small Chip size



Medium Chip size

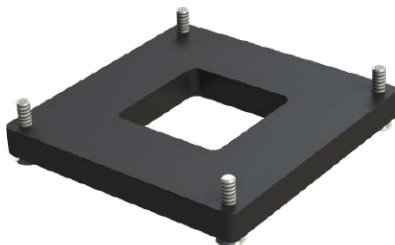

Large Chip size

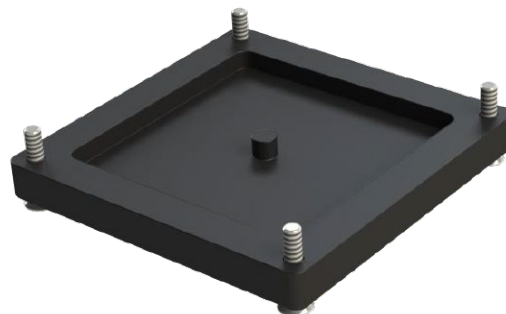

Custom assembly boards

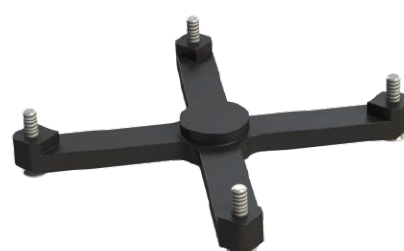
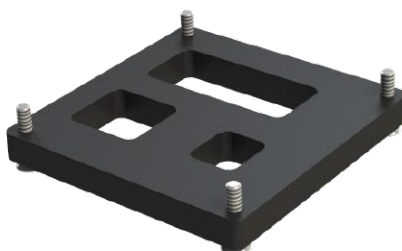
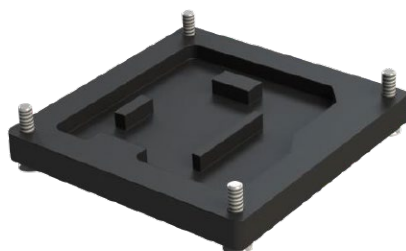

How to order

LP # # # # -089# - # # # # # 55L #

Shape of tip
P : Pointed
Options:
C : Crown

Nbr of contacts
 Depends on ballcount of chip

Contact type
91 to 98 : See "Contacts specification" chart
90 : Standard solderless compression style
9M : Special mixed contact style

Plating
55L: Gold + Locating pegs
 Other on request

Option code (see page 16-19)
D : Dead bug
M : Multi frames
U : Multi packages
C : Converter plate
S : Custom opening slot
H : Heatsink
F : Fan + Heatsink
P : Thermal drain pad
W : Transparent lid
I : Steel retention lid
B : Aluminium retention lid
T : Torque tool fixture
G : Handling button

Retention frame type (Lid) (see page 12-15)

W : TwistLock	S : ScrewLock
F : FastLock	Q : Open QuickLock (<200 contacts)
B : SpringLock	D : QuickLock (>200 contacts)
H : Open Clamshell Alu (<200 contacts)	M : Injection Molded ClamShell
J : Clamshell Alu (>200 contacts)	R : ReverseLock
L : Open Lever Clamshell Alu (>200 contacts)	T : SlimLock

Grid code / Config. code
 Will be given by the factory after receipt of the chip datasheet

