

# Probe Pin Solderless Compression Test Socket

For LGA / QFN / MLF / MLP / LCC Package

0.50 mm pitch (from 0.50 mm to 0.79 mm)

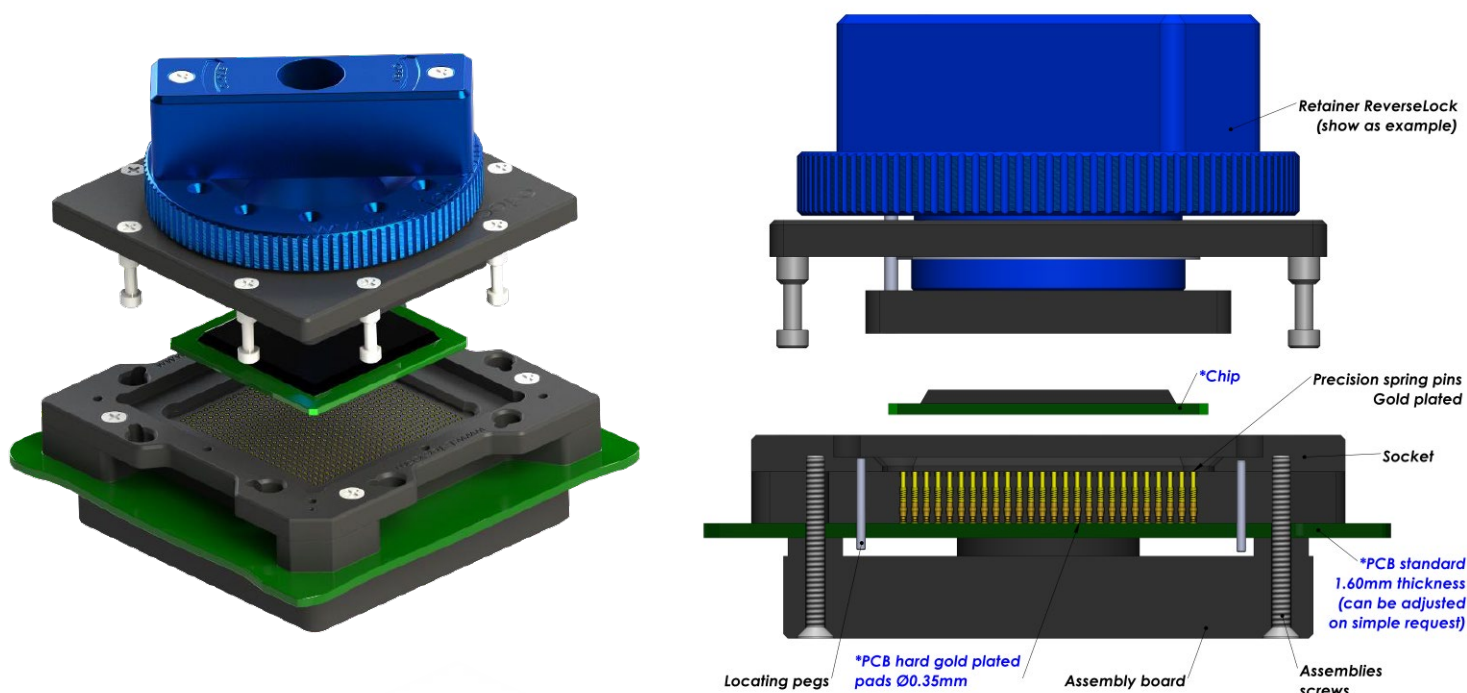
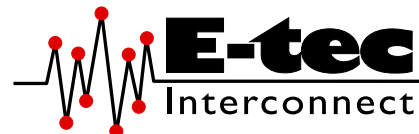

**E-tec Interconnect AG is the world leading Test socket manufacturer**

Probe Pin (Pogo) Solderless compression Test Sockets type are available for any chip size and pitch and are attached with 2, 4 or 8 screws to the PCB. The assembly board ensures perfect coplanarity of the socket. Contact reliability is guaranteed with spring loaded gold plated contacts, which are pressed onto gold plated PCB pads. Probe Pin (Pogo) Solderless compression type sockets are available with all retention systems. We aim to solve your requirements. Please note, we will always request the chip data to ensure we offer a compatible socket.

Contacts Specifications						
Contact type code	0590	0591	0592	0593	0594	0598
Application	Standard	Long live	High Frequency	High Temp & Long live	High Power	SuperHigh Frequency
Mounting	Solderless	Solderless	Solderless	Solderless	Solderless	Solderless
Bandwidth (GHz@-1dB)	3 GHz	7 GHz	29 GHz	8.9 GHz	9 GHz	40 GHz
Contact resistance	<100 mOhm	40 mOhm	100 mOhm	80 mOhm	80 mOhm	100 mOhm
Chip contact tip shape	Single Point tip Concave tip	Crown tip	Single Point tip	Crown tip	Crown tip	Single Point tip
PCB tip shape	Single Point tip	Single Point tip	Single Point tip	Single Point tip	Single Point tip	Spring
Force	30 gr	23 gr	20 gr	23 gr	30 gr	20 gr
Current rating	1.5 A	1 A	1.5 A	2 A	2 A	0.5 A
Capacitance pF	<1 pF	0.45 pF	0.48 pF	0.71 pF	na	0.36 pF
Inductance nH	<2 nH	1.08 nH	0.89 nH	0.67 nH	na	1.19 nH
Impedance Ohms	38 Ω	39 Ω	38 Ω	55 Ω	60 Ω	62 Ω
Temperature range	-55°C to +150°C	-50°C to +150°C	-40°C to +120°C	-50°C to +220°C	-50°C to +220°C	-55°C to +150°C
Mating cycles	100 K	300 K	100 K	500 K	500 K	100 K

More on the next page



# Probe Pin Solderless Compression Test Socket

For LGA / QFN / MLF / MLP / LCC Package

0.50 mm pitch (from 0.50 mm to 0.79 mm)

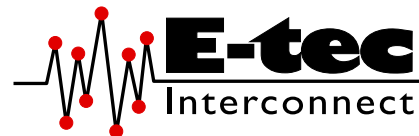

## Standard assembly boards

Small Chip size



Medium Chip size

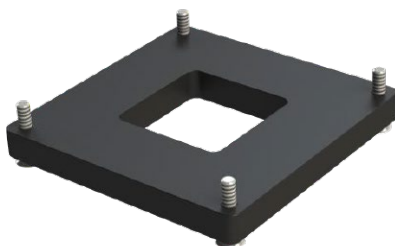

Large Chip size



## Custom assembly boards

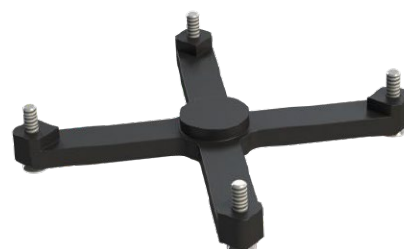
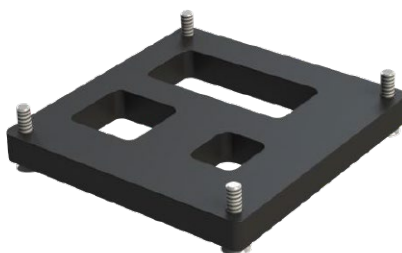
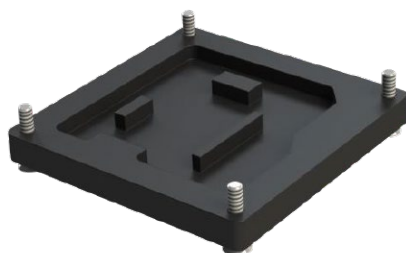

## How to order

**LP # # # # # -059# - # # # # # # 55L #**

**Shape of tip**  
**P** : Pointed  
**Options:**  
**C** : Crown

**Nbr of contacts**  
 Depends on ballcount of chip

**Contact type**  
**91 to 98** : See "Contacts specification" chart  
**90** : Standard solderless compression style  
**9M** : Special mixed contact style

**Plating**  
**55L** : Gold + Locating pegs  
 Other on request

**Option code** (see page 16-19)  
**D** : Dead bug  
**M** : Multi frames  
**U** : Multi packages  
**C** : Converter plate  
**S** : Custom opening slot  
**H** : Heatsink  
**F** : Fan + Heatsink  
**P** : Thermal drain pad  
**W** : Transparent lid  
**I** : Steel retention lid  
**B** : Aluminium retention lid  
**T** : Torque tool fixture  
**G** : Handling button

**Retention frame type (Lid)** (see page 12-15)

<b>W</b> : TwistLock	<b>S</b> : ScrewLock
<b>F</b> : FastLock	<b>Q</b> : Open QuickLock (<200 contacts)
<b>B</b> : SpringLock	<b>D</b> : QuickLock (>200 contacts)
<b>H</b> : Open Clamshell Alu (<200 contacts)	<b>M</b> : Injection Molded ClamShell
<b>J</b> : Clamshell Alu (>200 contacts)	<b>R</b> : ReverseLock
<b>L</b> : Open Lever Clamshell Alu (>200 contacts)	<b>T</b> : SlimLock

**Grid code / Config. code**  
 Will be given by the factory after receipt of the chip datasheet

