

Probe Pin Solderless Compression Test Socket

For BGA / Bumped chip / WLCSP / eMMC Package

1.00 mm pitch (from 1.00 mm to 1.26 mm)

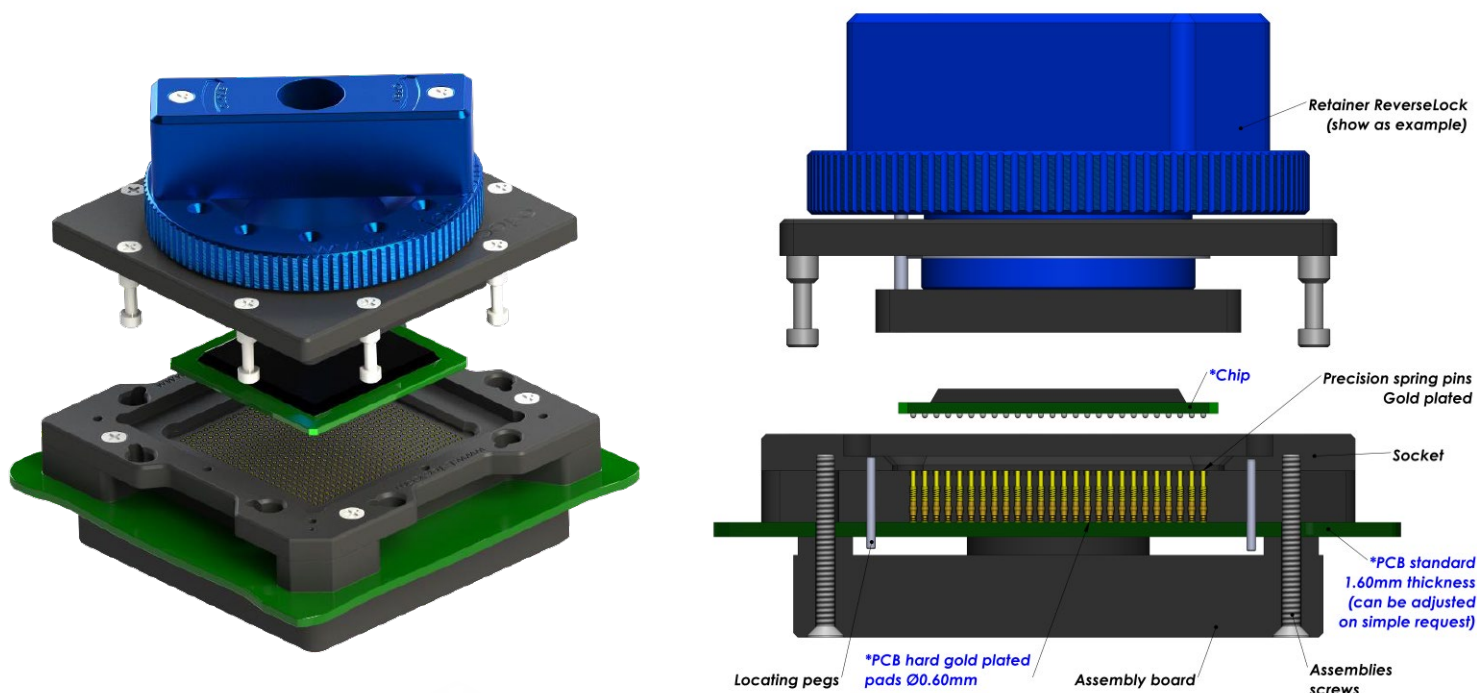
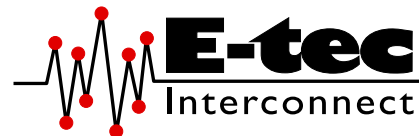

E-tec Interconnect AG is the world leading Test socket manufacturer

Probe Pin (Pogo) Solderless compression Test Sockets type are available for any chip size and pitch and are attached with 2, 4 or 8 screws to the PCB. The assembly board ensures perfect coplanarity of the socket. Contact reliability is guaranteed with spring loaded gold plated contacts, which are pressed onto gold plated PCB pads. Probe Pin (Pogo) Solderless compression type sockets are available with all retention systems. We aim to solve your requirements. Please note, we will always request the chip data to ensure we offer a compatible socket.

Contacts Specifications						
Contact type code	1090	1091	1092	1093	1094	1098
Application	Standard	Long Live	High Frequency	High Power	Frequency	Frequency
Mounting	Solderless	Solderless	Solderless	Solderless	Solderless	Solderless
Bandwidth (GHz@-1dB)	3 GHz	11 GHz	31 GHz	10 GHz	9.4 GHz	30.3 GHz
Contact resistance	<100 mOhm	45 mOhm	100 mOhm	30 mOhm	25 mOhm	25 mOhm
Chip contact tip shape	Single Point tip Concave tip	Crown tip	Single Point tip	Round tip	Single Point tip	Single Point tip
PCB tip shape	Single Point tip	Single Point tip	Single Point tip	Single Point tip	Spring	Spring
Force	25 gr	35 gr	33 gr	30 gr	25 gr	25 gr
Current rating	1.8 A	3 A	1 A	4 A	5 A	2.6 A
Capacitance pF	<1 pF	0.55 pF	0.39 pF	0.19 pF	0.85 pF	0.54 pF
Inductance nH	<2 nH	0.76 nH	1.01 nH	0.93 nH	1.36 nH	1.70 nH
Impedance Ohms	45 Ω	36 Ω	46 Ω	38 Ω	35 Ω	59.9 Ω
Temperature range	-55°C to +150°C	-40°C to +120°C	-50°C to +120°C	-55°C to +180°C	-55°C to +150°C	-55°C to +150°C
Mating cycles	100 K	300 K	100 K	125 K	100 K	100 K

More on the next page



Probe Pin Solderless Compression Test Socket

For BGA / Bumped chip / WLCSP / eMMC Package

1.00 mm pitch (from 1.00 mm to 1.26 mm)

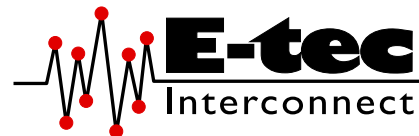

Standard assembly boards

Small Chip size



Medium Chip size

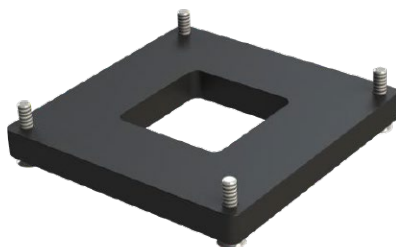

Large Chip size

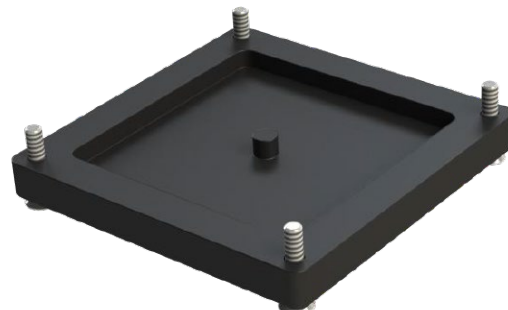

Custom assembly boards

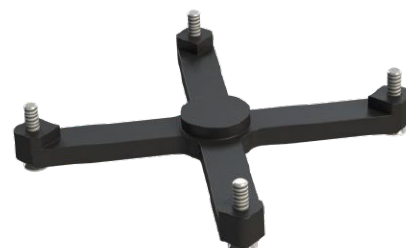
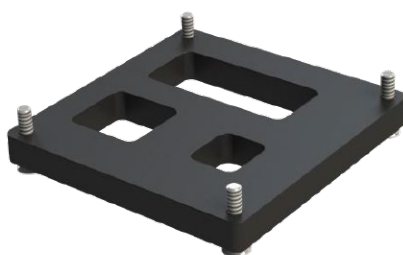
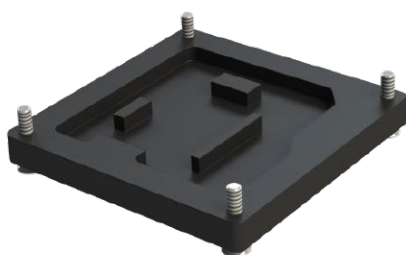

How to order

BU # ##### -109# - ##### 55L #

<p>Shape of tip</p> <p>U : Concave</p> <p>Options:</p> <p>P : Pointed</p> <p>S : Spring</p> <p>C : Crown</p>	<p>Nbr of contacts</p> <p>Depends on ballcount of chip</p>	<p>Contact type</p> <p>91 to 98 : See "Contacts specification" chart</p> <p>90 : Standard solderless compression style</p> <p>9M: Special mixed contact style</p>	<p>Plating</p> <p>55L: Gold + Locating pegs</p> <p>Other on request</p>	<p>Option code (see page 16-19)</p> <p>D : Dead bug</p> <p>M : Multi frames</p> <p>U : Multi packages</p> <p>S : Custom opening slot</p> <p>H : Heatsink</p> <p>F : Fan + Heatsink</p> <p>P : Thermal drain pad</p> <p>W: Transparent lid</p> <p>I : Steel retention lid</p> <p>B : Aluminium retention lid</p> <p>T : Torque tool fixture</p> <p>G : Handling button</p>
<p>Retention frame type (Lid) (see page 12-15)</p> <p>W: TwistLock</p> <p>F : FastLock</p> <p>B : SpringLock</p> <p>H : Open Clamshell Alu (<200 contacts)</p> <p>J : Clamshell Alu (>200 contacts)</p> <p>L : Open Lever Clamshell Alu (>200 contacts)</p> <p>S : ScrewLock</p> <p>Q : Open QuickLock (<200 contacts)</p> <p>D : QuickLock (>200 contacts)</p> <p>M : Injection Molded ClamShell</p> <p>R : ReverseLock</p> <p>T : SlimLock</p>		<p>Grid code / Config. code</p> <p>Will be given by the factory after receipt of the chip datasheet</p>		

