

Elastomer Solderless Compression Test Socket

For BGA / Bumped chip / WLCSP / eMMC Package

0.40 mm pitch (from 0.40 mm to 0.49 mm)

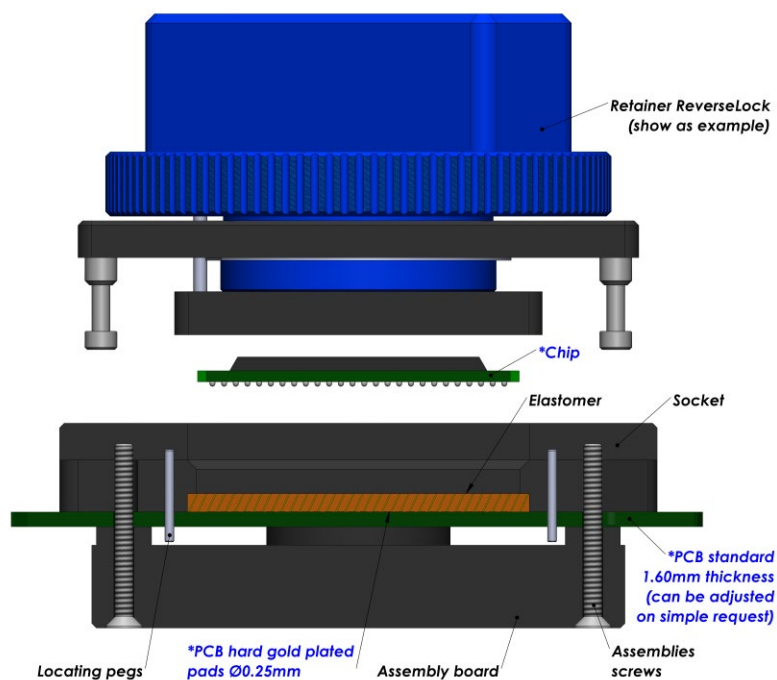
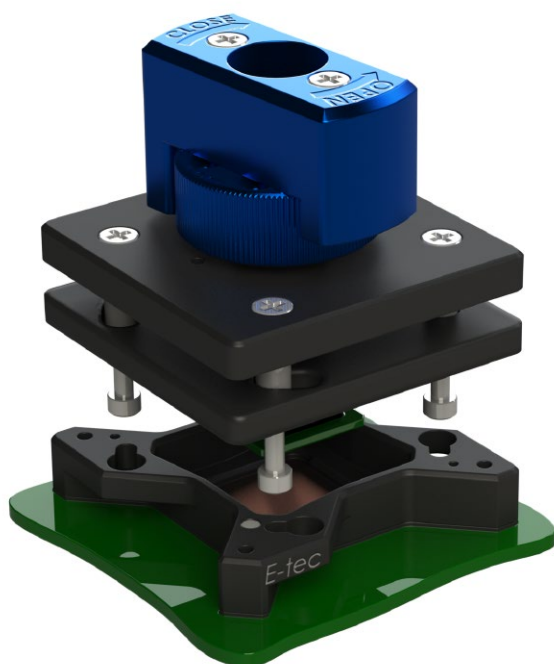
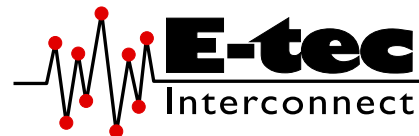

E-tec Interconnect AG is the world leading Test socket manufacturer

The Elastomer Solderless compression Test Sockets are ideal technical solution for good signal integrity with low signal loss. The sockets are available for any chip size and pitch and are attached with 2, 4 or 8 screws to the PCB. The socket outline will be kept to a minimum and special clearances can be offered to avoid components on the PCB.

SMT and thru-hole adapter sockets are available in certain pitches (contact factory for availability first) with these elastomer interposers to allow using this high frequency interposer on PCB's which have already been laid out for SMT or thru-hole sockets. We aim to solve your requirements. Please note, we will always request the chip data to ensure we offer a compatible socket.

Contacts Specifications			
Contact type code	E1	E2	E3
Application	High Frequency		
Mounting	Solderless	Solderless	Solderless
Bandwidth (GHz@-1dB)	8.4 GHz	16.5 GHz	21.3 GHz
Contact resistance	30 mOhm		
Chip contact tip shape	Gold Wire		
PCB tip shape	Gold Wire		
Force	20 gr to 50 gr		
Current rating	2.5 A		
Capacitance pF	0.28 pF	0.13 pF	0.10 pF
Inductance nH	0.26 nH	0.07 nH	0.06 nH
Impedance Ohms	34.7 Ω	38.9 Ω	42.1 Ω
Temperature range	-40°C to +125°C		
Mating cycles	1 K		

More on the next page



Elastomer Solderless Compression Test Socket

For BGA / Bumped chip / WLCSP / eMMC Package

0.40 mm pitch (from 0.40 mm to 0.49 mm)

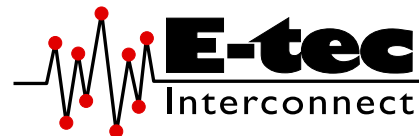

Standard assembly boards

Small Chip size



Medium Chip size

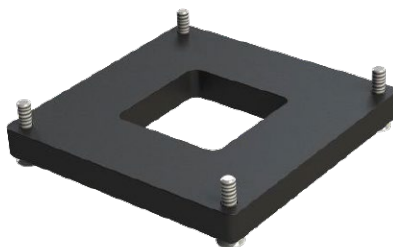

Large Chip size



Custom assembly boards

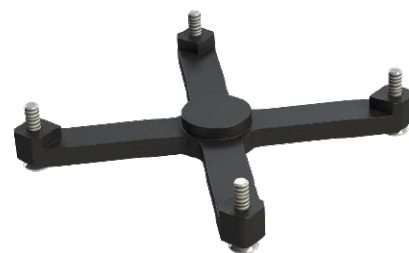
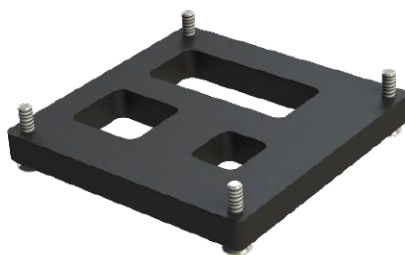
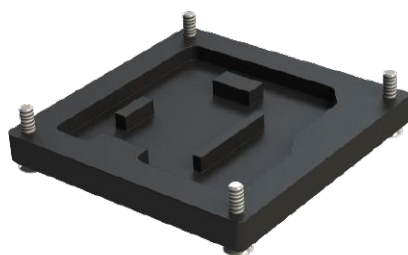

How to order

BE# #### -04E# - ##### 55L #

<p>Shape of tip E : Elastomer</p>	<p>Nbr of contacts Depends on ballcount of chip</p>	<p>Contact type E1 : High Frequency 8.4 GHz E2 : High Frequency 16.5 GHz E3: High Frequency 21.3 GHz</p>	<p>Plating 55L: Gold + Locating pegs</p>	<p>Option code (see page 16-19) M : Multi frames U : Multi packages S : Custom opening slot H : Heatsink F : Fan + Heatsink W: Transparent lid I : Steel retention lid B : Aluminium retention lid G : Handling button</p>
<p>Retention frame type (Lid) (see page 12-15)</p> <p>W: TwistLock F : FastLock B : SpringLock H : Open Clamshell Alu (<200 contacts) J : Clamshell Alu (>200 contacts) L : Open Lever Clamshell Alu (>200 contacts)</p> <p>S : ScrewLock Q : Open QuickLock (<200 contacts) D : QuickLock (>200 contacts) M : Injection Molded ClamShell R : ReverseLock T : SlimLock</p>		<p>Grid code / Config. code Will be given by the factory after receipt of the chip datasheet</p>		

