

INDEX



Part-Number	Page	Part-Number	Page	Part-Number	Page
BB1 - 4 xx - S43 x - 55/2	52	CRF - 999/27 - S250 - 99	127	FCZ - xxx - H080 - 99	OBSOLETE 96
BB1 - xxx - B850 - 55	73	CRF - 999/27 - UT250 - 99	128	FCZ - xxx - H081 - 99	OBSOLETE 96
BB1 - xxx - S50 x - 55	74	CRF - 999/28 - F254 - 99	129	FCZ - xxx - H100 - 99/x	EOL / Replacement 98
BB2 - x xx - S430 - 55/2	52	CRF - 999/28 - R250 - 99	127	FCZ - xxx - H101 - 99/x	EOL / Replacement 98
BB2 - xxx - B850 - 55	73	CRF - 999/29 - C200 - 99	126	FCZ - xxx - H102 - 99/x	98
BB2 - xxx - S500 - 55	74	CRF - 999/30 - K200 - 99	126-1	FCZ - xxx - H103 - 99/x	98
BE x - xxx - S xxx - 55	72	CRF - 999/30 - O200 - 99	125	FCZ - xxx - H115 - 99/x	OBSOLETE 100
BE x - xxx - S8 xx - 55/2	50	CRF - 999/30 - SH200 - 99	126-1	FCZ - xxx - H116 - 99/x	OBSOLETE 100
BF x - xxx - S500 - 55	71	CRF - 999/35 - D125 - 95	124	FCZ - xxx - R100 - 99	EOL / Replacement 102
BF x - xxx - S680 - 55	71	CRF - 999/35 - K150 - 99	124A	FCZ - xxx - R101 - 99	EOL / Replacement 102
BF x - xxx - S710 - 55	71	CRF - 999/35 - L100 - 99	123	FCZ - xxx - R125 - 99	OBSOLETE 110
BF x - xxx - S850 - 55	71	CRF - 999/35 - S125 - 99	124	FCZ - xxx - RL100 - 99	102
BF1 - xxx - R500 - 55	71	CRF - 999L/27 - H254 - 95	129	FCZ - xxx - RL101 - 99	102
BH x - xxx - R850 - 55	76	CRF - 999X/32 - H200 - 55	125	FCZ - xxx - S100 - 99	EOL / Replacement 101
BH2 - xxx - R345 - 55/11	30	CRF - 1 xx - C200	126	FCZ - xxx - S125 - 99	OBSOLETE 110
BH2 - xxx - R450 - 55/2	53	CRR - 1 xx - F254 - 99	129	FCZ - xxx - SL100 - 99	101
BL x - xxx - R842 - 55	69	CRR - 1 xx - I250 - 99	127	FCZ - xxx - SR100 - 99	EOL / Replacement 101
BL x - xxx - S400 - 55/2	48	CRR - 1 xx - K150 - 99	124A	FCZ - xxx - V050 - 99/x	EOL / Replacement 91
BL x - xxx - S430 - 55/2	48	CRR - 1 xx - O200 - 99	125	FCZ - xxx - VC50 - 99/xx	91
BL x - xxx - S460 - 55/1	29	CRR - 1 xx - P200 - 99/P	126-1	FCZ - xxx - VC51 - 99/xx	91
BL x - xxx - S570 - 55	70	CRR - 1 xx - P250 - 99	128	FCZ - xxx - V052 - 99/xx	OBSOLETE 93
BL x - xxx - S842 - 55	69	CRR - 1 xx - R250 - 99	127	FCZ - xxx - V053 - 99/xx	OBSOLETE 93
BL x - xxx - S850 - 55/1	29	CRR - 1 xx - S125 - 99	124	FCZ - xxx - V100 - 99/xx	EOL / Replacement 97
BL x - xxx - SH635 - 55/2	49	CRR - 1 xx - S250 - 99	127	FCZ - xxx - VZ100 - 99/xx	97
BL1 - xxx - R430 - 55/2	48	CRR - 1 xx - SD125 - 99/R	124	FCZ - xxx - V115 - 99/xx	OBSOLETE 99
BL1 - xxx - R570 - 55	70	CRR - 1 xx - SH200 - 99/X	126-1	FPC - xxx - R254 - 99	112
BL2 - xxx - R430 - 55/11	28	CRR - 1 xx - SK150 - 99/R	124A	FPC - xxx - S254 - 99	111
BL2 - xxx - R720 - 55/2	48	CRR - 1 xx - SK200 - 99/X	126-1	IDC - xxx - S100 - N5	90
BL x - xxx - RH635 - 55/2	49-1	CRR - 1 xx - SL100 - 99/R	123	IDC - xxx - W100 - N5	90
BL2 - xxx - S340 - 55/11	28	CRR - 1 xx - SS125 - 99/R	124	IDD - xxx - L100 - 95	82
BL2 - xxx - S430 - 55/11	28	CRR - 1 xx - UT250 - 99	128	IDD - xxx - LE100 - N5	82
BL4 - xxx - S630/x - 55/2	51	CRR - 1 xx - C200 - 99	126	IDD - xxx - S100 - N5	82
BS1 - xxx - B21x - 55/11 XX	35	CRR - 2 xx - SL100 - 99/R	123	IDD - xxx - SE100 - N5	82
BS1 - xxx - H43 x - 55/2 X	54	CRR - 2 xx - D200 - 99	126	IDF - 1 xx/X - P396 - 99	131
BS1 - xxx - H45 x - 55/11 XX	32	CRS - 1 xx - F254 - 99	129	IDF - 1 xx/X - PC396 - 99	131
BS1 - xxx - H50 x - 55/X	77	CRS - 1 xx - I250 - 99	127	IDH - xxx - E100 - N5	82
BS1 - xxx - H75 x - 55/X	77	CRS - 1 xx - K150 - 99	124A	IDH - xxx - ES100 - N5	82
BS1 - xxx - R390 - 55/X	79	CRS - 1 xx - O200 - 99	125	IDH - xxx - W100 - N5	82
BS1 - xxx - T22 x - 55/11 XX	35	CRS - 1 xx - P200 - 99/P	126-1	IDH - xxx - WS100 - N5	82
BS1 - xxx - TB22 - 55/2 X	55	CRS - 1 xx - P250 - 99	128	IDP - xxx - S100 - N5	85
BS2 - xxx - H222 - 55/00 X	14	CRS - 1 xx - R250 - 99	127	IDP - xxx - S200 - N5	84
BS2 - xxx - H360 - 55/11 X	34	CRS - 1 xx - S125 - 99	124	IDP - xxx - S300 - N5	85
BS2 - xxx - H36A - 55/11 X	34	CRS - 1 xx - S250 - 99	127	IDP - xxx - S600 - N5	85
BS2 - xxx - H430 - 55/2 X	54	CRS - 1 xx - SH200 - 99/X	126-1	IDP - xxx - T050 - 99	86
BS2 - xxx - H450 - 55/11 X	33	CRS - 1 xx - SK150 - 99/B	124A	IDS - xxx - S100 - N5/X	80
BS2 - xxx - H45A - 55/11 X	33	CRS - 1 xx - SL100 - 99/B	123	IDS - xxx - S200 - N5/X	58
BS2 - xxx - H45B - 55/11 X	33	CRS - 1 xx - SP250 - 99/X	128	IDS - xxx - W050 - 55/ X	38
BS2 - xxx - H45P - 55/11 X	33	CRS - 1 xx - SS125 - 99/X	124	IDS - xxx - W100 - N5/X	80
BS2 - xxx - H500 - 55/X	77	CRS - 1 xx - UT250 - 99	128	IDS - xxx - W200 - N5/X	58
BS2 - xxx - H600 - 55/1 X	31	CRS - 1 xx - C200 - 99	126	JPC - 127 - BL - 55	83
BS2 - xxx - H750 - 55/X	77	CRS - 1 xx - SC200 - 99/x	126	JPC - 200 - BL - 55	83
BS2 - xxx - R345 - 55/11 X	37	CRS - 2 xx - SL100 - 99/E	123	JPC - 254 - XX - 55	83
BS2 - xxx - R390 - 55/X	79	CRS - 2 xx - D200 - 99	126	JPC - 508 - BL - 55	83
BS2 - xxx - R500 - 55/2 X	57	DHL - xxx - R100 - 55	81	JPE - 200 - XX - 55	83
BS2 - xxx - TB22 - 55/11 X	36	DHL - xxx - S100 - 55	81	JPE - 254 - XX - 55	83
BS2 - xxx - TB22 - 55/2 X	56	DHS - xxx - R100 - 55	81	JPH - 200 - XX - 55	83
BS2 - xxx - TB28 - 55/2 X	56	DHS - xxx - S100 - 55	81	JPH - 254 - XX - 55	83
BS2 - xxx - TB365 - 55/X	78	DHW - xxx - R100 - 55	81	JPM - xx - 200 - BL - 55	83
BW2 - xxx - R850 - 55/P	75	DHW - xxx - S100 - 55	81	JPM - xx - 254 - BL - 55	83
BW2 - xxx - S850 - 55/P	75	ECC - 120 - P050 - 95	87	JPW - 102 - 55	83
CRF - 1 xx - D125	124	ECC - 184 - P053 - 95	87	JPW - 254 - 55	83
CRF - 1 xx - F254	129	ECC - 184 - P055 - 95	87	JPW - 508 - 55	83
CRF - 1 xx - H200	125	ECC - xxx - RC100 - 95	89A	JPW - 762 - 55	83
CRF - 1 xx - H254	129	ECC - xxx - S050 - 95/x	88	MMF - xxx - DC50 - 99	115
CRF - 1 xx - I250	127	ECC - xxx - SC100 - 95	89A	MFP - xxx - DC50 - 99	116
CRF - 1 xx - K150	124A	ECC - xxx/X - R100 - 95	89	MMF - xxx - RB50 - 99	121
CRF - 1 xx - K200	126-1	ECC - xxx/X - S100 - 95	89	MMF - xxx - RL50 - 99	121A
CRF - 1 xx - L100	123	FCA - x xx - X xxx - xxxxxx - x	113	MMF - xxx - SB50 - 99	119
CRF - 1 xx - O200	125	FCL - xxx - H100 - 99/x	104	MMF - xxx - SL50 - 99	120
CRF - 1 xx - P200	126-1	FCL - xxx - H125 - 99/X	107	MMF - xxx - HB50 - 99/X	117
CRF - 1 xx - P250	128	FCL - xxx - R100 - 99	106	MMF - xxx - HL50 - 99/X	118
CRF - 1 xx - R250	127	FCL - xxx - R125 - 99	109	MMM - xxx - HS50 - 99/X	122A
CRF - 1 xx - S125	124	FCL - xxx - S100 - 99	105	MMM - xxx - SS50 - 99	122
CRF - 1 xx - S250	127	FCL - xxx - S125 - 99	108	PCC - 1 xx - PM635/x	136
CRF - 1 xx - SH200	126-1	FCL - xxx - V100 - 99/xx	103	PCC - 3 xx - P635/x	136-1
CRF - 1 xx - UT250	128	FACT - x xx - C xxx - xx	114	PCF - 1 xx - F396	131
CRF - 2 xx - D200	126	FCT - x xx - S xxx - xx	114	PCF - 1 xx - F508	134
CRF - 2 xx - H200	125	FCT - x xx - T xxx - xx	114	PCF - 1 xx - P420	132
CRF - 2 xx - H254	129	FCZ - xxx - H050 - 99/x	EOL / Replacement 92	PCF - 1 xx - P508	134
CRF - 2 xx - H254/HP	129	FCZ - xxx - H051 - 99/x	EOL / Replacement 92	PCF - 1 xx - P635/x	136
CRF - 2 xx - L100	123	FCZ - xxx - HC50 - 99/x	92	PCF - 1 xx - Q396	131
CRF - 999/27 - DP200 - 99	126 & 126-1	FCZ - xxx - HC51 - 99/x	92	PCF - 1 xx - W300	130
CRF - 999/27 - H254 - N5	129	FCZ - xxx - H052 - 99/x	OBSOLETE 94	PCF - 104 - I508 - 99/X	134
CRF - 999/27 - I250 - 99	127	FCZ - xxx - H053 - 99/x	OBSOLETE 94	PCF - 2 xx - BSC420 - 99	133-2
CRF - 999/27 - P250 - 99	128	FCZ - xxx - H058 - 99/x	95	PCF - 2 xx - P420	133

Part-Number	Page	Part-Number	Page	Part-Number	Page
PCF - 2 xx - W300	130-2	PCS - 1 xx - SC300 - 99/XX	130	SL3 - xxx - SH xxx/xx - xx	59
PCF - 3 xx - P635/x	136-1	PCS - 1 xx - SW300 - 99/B	130	SL3 - xxx - U xxx/xx - xx	60
PCF - 999/20 - F396 - 99	131	PCS - 1 xx - W300 - 99	130	SL3 - xxx - UH xxx/xx - xx	60
PCF - 999/20 - F508 - 99	134	PCS - 1 xx - WC300 - 99	130	SL4 - xxx - S830/x - 55/2	41
PCF - 999/xx - P508 - 99	134	PCS - 104 - T508 - 99	135	SLS - xxx - D xxx - 55	66
PCF - 999/xx - P635 - 99	136 & 136-1	PCS - 2 xx - BF420 - 99	133-2	SLS - xxx - D762/xx - 55/2	46
PCF - 999/xx - Q396 - 99	131	PCS - 2 xx - BM420 - 99	133-2	SLS - xxx - H510 - 55/11 X	27
PCF - 999/xxX - P420 - 99	132 & 133	PCS - 2 xx - P420 - 99	133	SLS - xxx - H562 - 55/2 X	47
PCF - 999X/xxX - W300 - 99	130 & 130-2	PCS - 2 xx - PN420 - 99	133	SLS - xxx - H610 - 55/11 X	26
PCM - 1 xx - C508	134	PCS - 2 xx - SC300 - 99/XX	130	SLS - xxx - H885 - 55/X	67
PCM - 1 xx - P420	133-1	PCS - 2 xx - SC300 - 99/XX	130-2	SLS - xxx - HP2x - 55/11 X	26
PCM - 1 xx - PN420	133-1	PCS - 2 xx - SW300 - 99/B	130-2	SLS - xxx - P535/x - 55/11	24
PCM - 1 xx - W300	130-1	PCS - 2 xx - W300 - 99	130-2	SLS - xxx - R103 - 55/X	68
PCM - 1 xx - WN300	130-1	PCS - 2 xx - BF300 - 99	130-4	SLS - xxx - R510 - 55/11	27
PCM - 2 xx - BC420	133-2	PCS - 2 xx - BM300 - 99	130-4	SLS - xxx - R562 - 55/2	46
PCM - 2 xx - P420	133-1	PCS - 3 xx - PF635 - 99/X	136-1	SLS - xxx - R565/x - 55/11	25
PCM - 2 xx - PN420	133-1	PCS - 3 xx - PM635 - 99/X	136-1	SLS - xxx - R920 - 55	66
PCM - 2 xx - W300	130-3	SE2 - xxx - R430 - xx /2	40	SLS - xxx - S103 - 55/X	68
PCM - 2 xx - WN300	130-3	SE2 - xxx - R635 - 55	61	SLS - xxx - S510 - 55/11	27
PCM - 999/19 - C508 - 99	134	SE2 - xxx - S400 - xx /2	40	SLS - xxx - S535 - 55/11	24
PCM - 999/xx - W300 - 99	130-1 & 130-3	SE2 - xxx - S740 - 55	61	SLS - xxx - S562 - 55/2	46
PCM - 999/xxX - P420 - 99	133-1 & 133-2	SL1 - xxx - B096/xx - xx /2	39	SLS - xxx - S920 - 55	66
PCM - 999X/xx - P635 - 99	136 & 136-1	SL1 - xxx - Bxxx/x - 55/11	15	SP x - xxx - S xxx/xx - xx	62
PCR - 1 xx - A420 - 99	132	SL1 - xxx - K106/xx - xx /2	39	SP x - xxx - SH xxx/xx - xx	62
PCR - 1 xx - F396 - 99	131	SL1 - xxx - N088/xx - xx /2	39	SP1 - xxx - N xxx/xx - 55/2	42
PCR - 1 xx - F508 - 99	134	SL1 - xxx - R xxx/xx - xx	60	SP1 - xxx - S xxx/xx - 55/11	18
PCR - 1 xx - P396 - 99	131	SL1 - xxx - R071/x - 55/11	17	SP1 - xxx - S xxx/xx - 55/1	19
PCR - 1 xx - P420 - 99	132	SL1 - xxx - R106/xx - xx /2	39	SP1 - xxx - S xxx/xx - 55/2	42
PCR - 1 xx - PWF635 - 99	136	SL1 - xxx - RH xxx/xx - xx	60	SP2 - xxx - HX065/x - 55/2 X	44
PCR - 1 xx - PWM635 - 99	136	SL1 - xxx - S xxx/xx - 55/1	19	SPx - xxx - H16x/xx - 55 X	64
PCR - 1 xx - Q396 - 99	131	SL1 - xxx - S xxx/xx - xx	59	SP2 - xxx - H220/x - 55/1 X	23
PCR - 1 xx - SC300 - 99/X	130-1	SL1 - xxx - S088/xx - xx /2	39	SP2 - xxx - H51/x - 55/00 X	13
PCR - 1 xx - SW300 - 99/R	130-1	SL1 - xxx - SH xxx/xx - xx	59	SP2 - xxx - H xx/x - 55/11 X	21
PCR - 1 xx - W300 - 99	130-1	SL1 - xxx - U xxx/xx - xx	60	SP2 - xxx - N xxx/xx - 55/2	42
PCR - 1 xx - W420 - 99	132	SL1 - xxx - UH xxx/xx - xx	60	SP2 - xxx - S xxx/x - 55/11	18
PCR - 1 xx - WC300 - 99/X	130-1	SL2 - xxx - B096/xx - xx /2	39	SP2 - xxx - S xxx/xx - 55/1	19
PCR - 104 - T508 - 99	135	SL2 - xxx - K106/xx - xx /2	39	SP2 - xxx - S xxx/xx - 55/2	42
PCR - 2 xx - BM420 - 99	133-2	SL2 - xxx - N088/xx - xx /2	39	SR1 - xxx - H093/x - 55/2 X	45
PCR - 2 xx - P420 - 99	133	SL2 - xxx - R xxx/xx - xx	60	SR1 - xxx - H135/xx - xx X	65
PCR - 2 xx - SC300 - 99/XX	130-3	SL2 - xxx - R071/x - 55/11	17	SR2 - xxx - H122/x - 55/2 X	45
PCR - 2 xx - SW300 - 99/R	130-3	SL2 - xxx - R106/xx - xx /2	39	SR2 - xxx - H135/xx - xx X	65
PCR - 2 xx - W300 - 99	130-2	SL2 - xxx - RH xxx/xx - xx	60	SS1 - xxx - H085/x - 55/2 X	43
PCR - 2 xx - W420 - 99	133	SL2 - xxx - S xxx/xx - 55/1	19	SS1 - xxx - H14 x /xx - 55 X	63
PCR - 2 xx - BF300 - 99	130-4	SL2 - xxx - S xxx/xx - xx	59	SS1 - xxx - H185/x - 55/2 X	43
PCR - 2 xx - BM300 - 99	130-4	SL2 - xxx - S088/xx - xx /2	39	SS1 - xxx - H38 x /x - 55/1 X	22
PCS - 1 xx - F396 - 99	131	SL2 - xxx - SH xxx/xx - xx	59	SS1 - xxx - TH14 x /xx - 55 X	63
PCS - 1 xx - F508 - 99	134	SL2 - xxx - Sxxx/x - 55/00	11	SS2 - xxx - HX064/x - 55/2 X	44
PCS - 1 xx - P396 - 99	131	SL2 - xxx - Sxxx/x - 55/11	16	SS2 - xxx - H085/x - 55/2 X	43
PCS - 1 xx - P420 - 99	132	SL2 - xxx - U xxx/xx - xx	60	SS2 - xxx - H140/xx - 55 X	63
PCS - 1 xx - PF635 - 99	136	SL2 - xxx - UH xxx/xx - xx	60	SS2 - xxx - H18/x - 55/00 X	12
PCS - 1 xx - PM635 - 99	136	SL3 - xxx - R xxx/xx - xx	60	SS2 - xxx - H380/x - 55/1 X	22
PCS - 1 xx - PN420 - 99	132	SL3 - xxx - RH xxx/xx - xx	60	SS2 - xxx - H7x/x - 55/11 X	20
PCS - 1 xx - Q396 - 99	131	SL3 - xxx - S xxx/xx - xx	59	SS2 - xxx - TH140/xx - 55 X	63

General information concerning the E-tec interconnect products

E-tec SMT connectors, male or female, are offered with a coplanarity of max. 0.10mm. They are adapted to all modern SMT soldering process and they can be handled easily with all currently existing placing techniques.

Customers may choose between various packaging options, such as Tray, Tube and Reel.

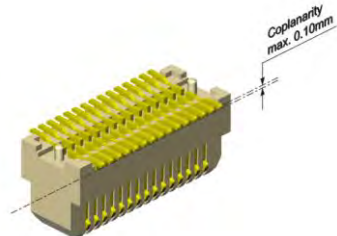

Tolerances:

All dimensions shown in this catalog represent average values. For precise +/- tolerance values please request a specific product datasheet. All pin header dimensions "A" have a general tolerance of +/- 0.25mm, unless otherwise indicated.

Plating:

- 99 = Standard Tin plating over Nickel
 - 55 = Standard Gold plating over Nickel
 - 95 = Standard selective Tin/Gold plating over Nickel
- Other platings are offered on request

Specifications:

The data contained in this catalog is of general nature and refers to standard products. For example a „Current rating“ at an ambient temperature of 25°C reflects the value per individual contact. Should you require any further data or test reports, you can obtain this information from your nearest E-tec sales office. The E-tec connectors conform with signal integrity requirements at high data and frequency rates. However we cannot offer a general information about the max. frequency or data transmission rate. For such a statement, it would require more information about the chosen configuration and pin-out, the length of the cable and/or any other specific requirements regarding the application itself and its related signal integrity.

GENERAL POLICY

All information contained in this catalog, including illustrations, specifications and dimensions are accurate to the best of our knowledge, and reflect the status as at the date of publication. Due to technical progress, it is subject to change without notice. Application information is informational in nature and shall not be construed to warrant suitability of products for any particular purpose as performance may vary depending on the conditions to which a product is subjected. Unless otherwise confirmed at the time of order, all E-tec products are non cancellable and non returnable items (NCNR). E-tec products are warranted for 30 days and the warranty is limited strictly to replacement of products. This warranty does not cover any claims for natural wear and tear, nor for any compensation, such as loss of production, loss of use, loss of orders, loss of profit, nor any other direct or indirect damages.

Fine Pitch Plug-Board Connectors

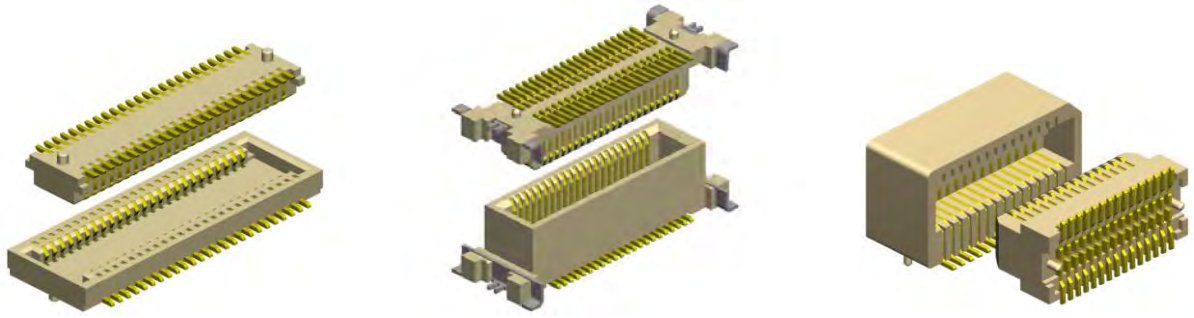

0.50mm - 0.60mm - 0.80mm pitch: Page 9

Board to Board & Wire to Board Connectors

PIN HEADER

Straight

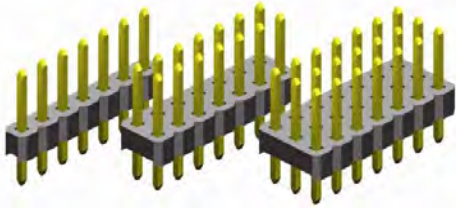

1.00mm pitch: Page 11
 1.27mm pitch: Page 15, 16 & 19
 2.00mm pitch: Page 39
 2.54mm pitch: Page 59

Right Angle

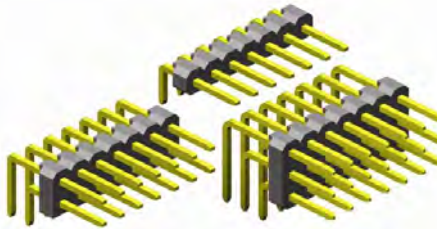

1.27mm pitch: Page 17
 2.00mm pitch: Page 39
 2.54mm pitch: Page 60

Double Plastic Board Spacer

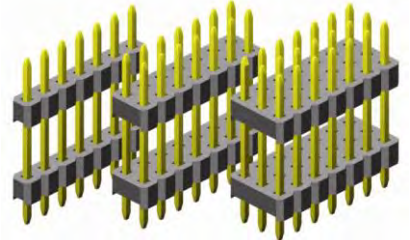

1.27mm pitch: Page 18 & 19
 2.00mm pitch: Page 42
 2.54mm pitch: Page 62

PC 104 Type

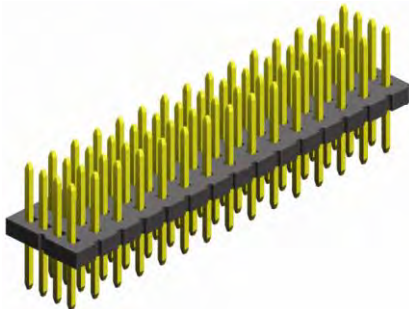

2.00mm pitch: Page 41

High Base "Board To Board"

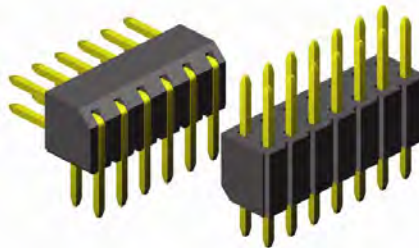

2.00mm pitch: Page 40
 2.54mm pitch: Page 61

SMT straight

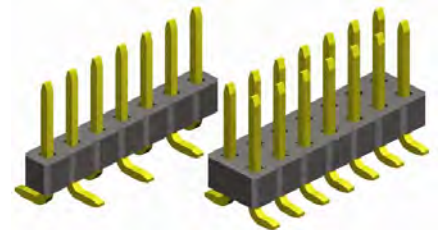

1.00mm pitch: Page 12
 1.27mm pitch: Page 20 & 22
 2.00mm pitch: Page 43 & 44
 2.54mm pitch: Page 63

SMT Double Plastic Board Spacer

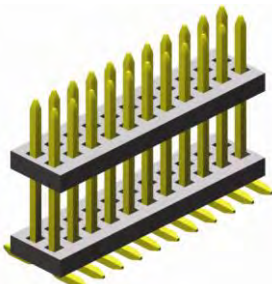

1.00mm pitch: Page 13
 1.27mm pitch: Page 21 & 23
 2.00mm pitch: Page 44
 2.54mm pitch: Page 64

SMT "slanted"



2.00mm pitch: Page 45
 2.54mm pitch: Page 65

Jumper & Shorting Links



1.27mm pitch: Page 83
 2.00mm pitch: Page 83
 2.54mm pitch: Page 83
 5.08mm pitch: Page 83

BOX HEADER

Straight Box Header

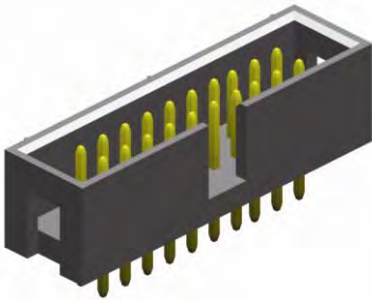

1.27mm pitch: Page 24 & 27
 2.00mm pitch: Page 46
 2.54mm pitch: Page 66

Right Angle Box Header

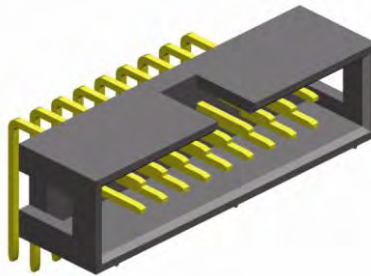

1.27mm pitch: Page 25 & 27
 2.00mm pitch: Page 46
 2.54mm pitch: Page 66

SMT Box Header

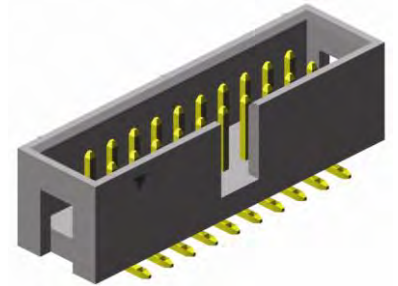

1.27mm pitch: Page 26 & 27
 2.00mm pitch: Page 47
 2.54mm pitch: Page 67

Box Header
with metal ejection latches
straight & right angle

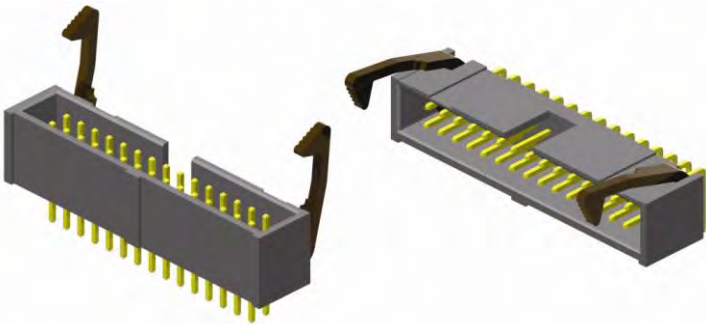

2.54mm pitch: Page 68

Box- & DIN 41 651 HEADER
with plastic ejection latches
straight & right angle

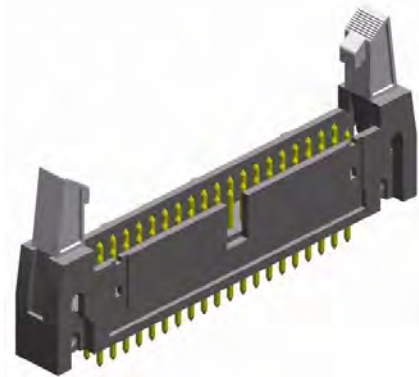

2.54mm pitch: Page 81

Mini - Flex Connectors

IDC Type for Ribbon Cable UL Style 2651

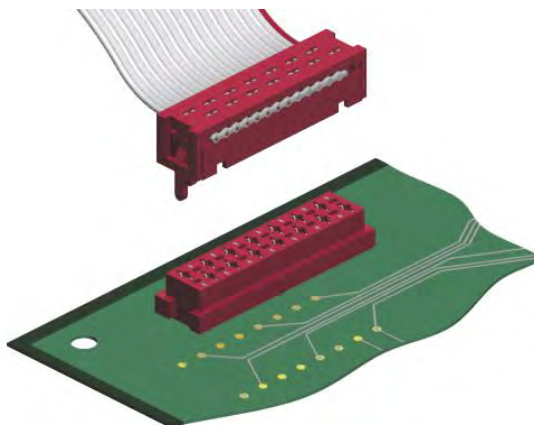

1.27mm pitch: Page 115 & 116

Mini - Mate Connectors

SMT & THT Type

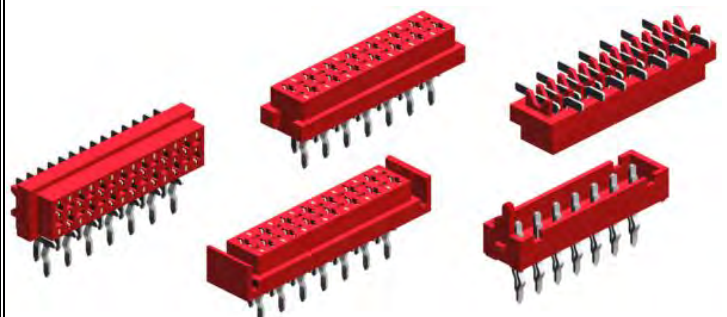

1.27mm pitch: Page 117 to 122A

FEMALE HEADERS

Straight Types single & dual row

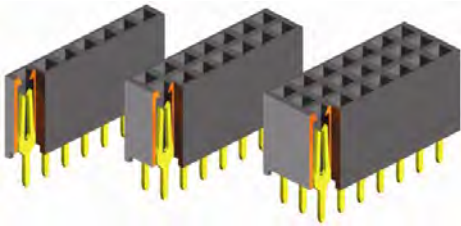

1.27mm pitch: Page 28 & 29
 2.00mm pitch: Page 48 & 49
 2.54mm pitch: Page 69 to 71

Right Angle Types

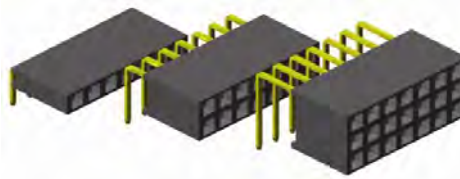

1.27mm pitch: Page 28
 2.00mm pitch: Page 48 & 49-1
 2.54mm pitch: Page 69 to 71

SMT "standard profile" Types

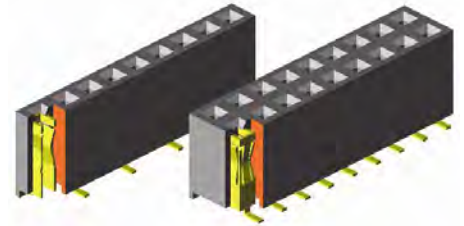

1.27mm pitch: Page 31 to 33
 2.00mm pitch: Page 54
 2.54mm pitch: Page 77

PC 104+ Type

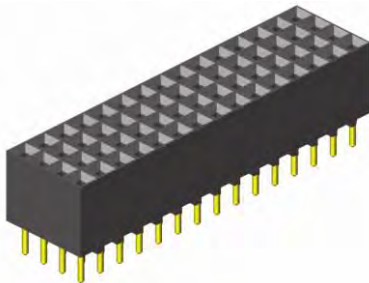

2.00mm pitch: Page 51

Elevated Types

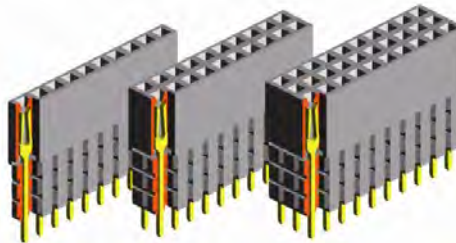

2.00mm pitch: Page 50
 2.54mm pitch: Page 72

SMT "low profile" Types

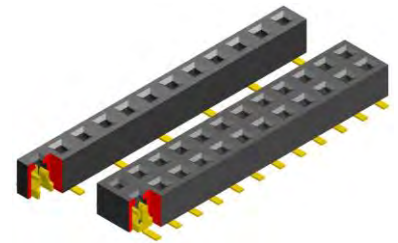

1.00mm pitch: Page 14
 1.27mm pitch: Page 34 to 36
 2.00mm pitch: Page 55 & 56
 2.54mm pitch: Page 78

Dual Entry Types "low profile"



2.00mm pitch: Page 52
 2.54mm pitch: Page 74

Dual Entry Type "standard profile"

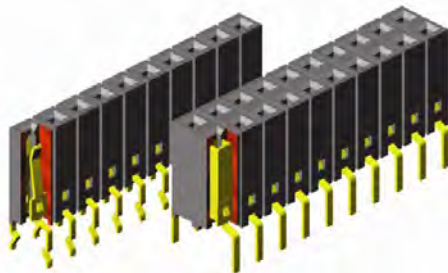

2.54mm pitch: Page 73

Shrouded Mating Types

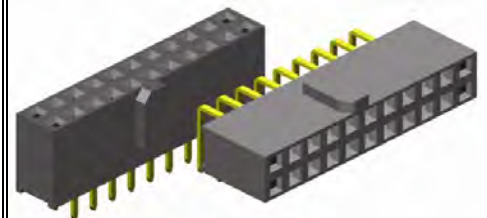

2.54mm pitch: Page 75

Through Hole (THT) Side Entry Types

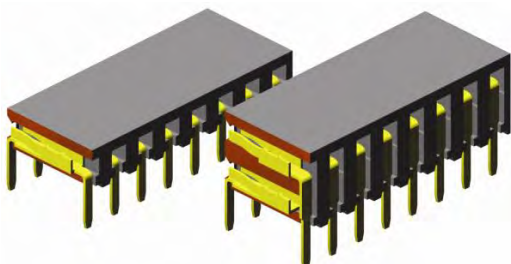

1.27mm pitch: Page 30
 2.00mm pitch: Page 53
 2.54mm pitch: Page 76

SMT Side Entry Types

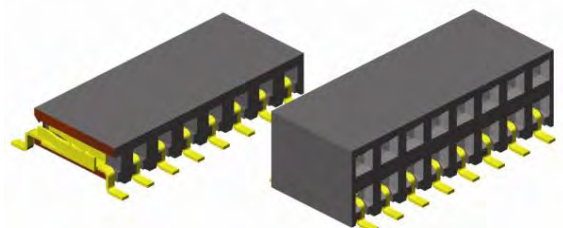

1.27mm pitch: Page 37
 2.00mm pitch: Page 57
 2.54mm pitch: Page 79

IDC CONNECTORS

IDC Female Headers

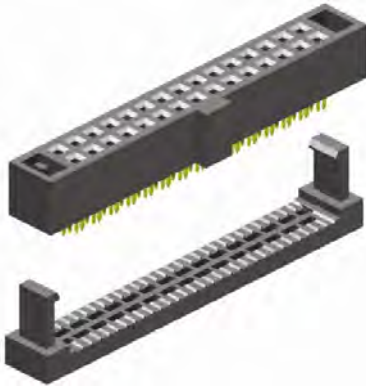

1.27mm pitch: Page 38
 2.00mm pitch: Page 58
 2.54mm pitch: Page 80

DIP Plugs

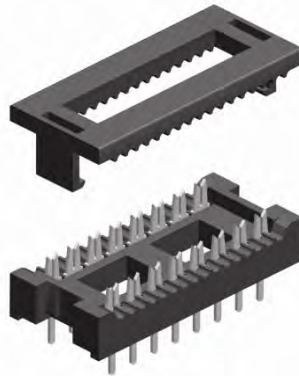

2.00mm x 2.00mm
 IDC pitch 1.00mm: Page 84
 2.54mm
 IDC pitch 1.27mm: Page 85

Transition Connectors

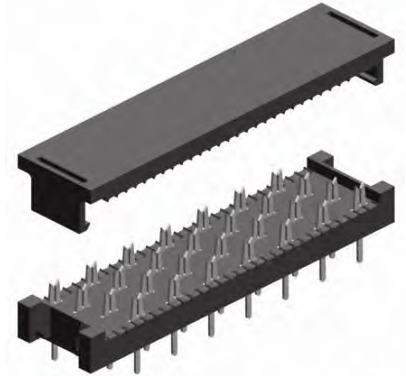

2.54mm
 IDC pitch 1.27mm: Page 86

IDC Box Headers

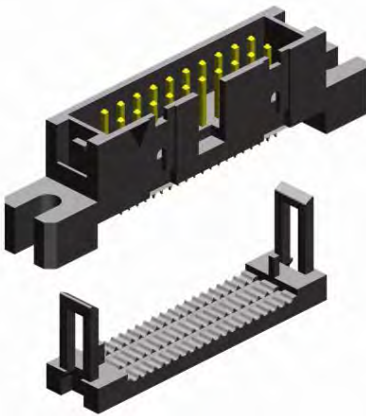

2.54mm pitch: Page 82

IDC DIN Headers DIN 41 651

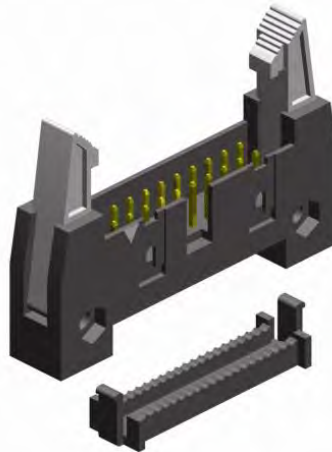

2.54mm pitch: Page 82

IDC Card Edge Connectors

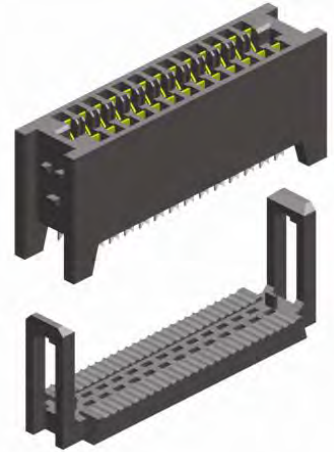

2.54mm pitch: Page 90

CARD EDGE CONNECTORS

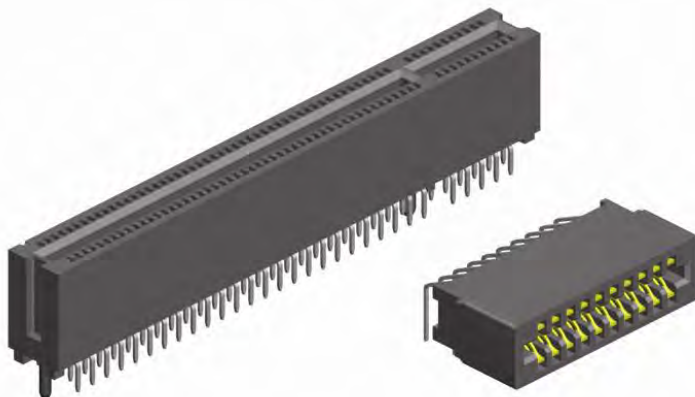

PCI 1.27mm pitch : Page 87
 Card Edge 1.27mm pitch : Page 88
 Card Edge 2.54mm pitch : Page 89 & 89A

FPC/FFC CONNECTORS

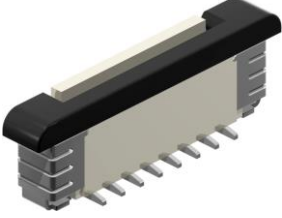
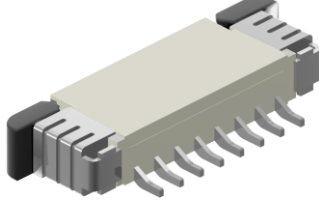
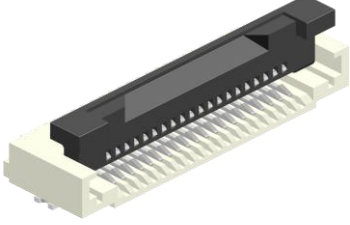
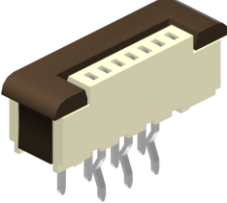
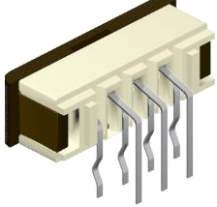
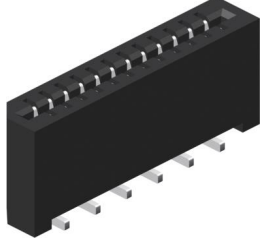
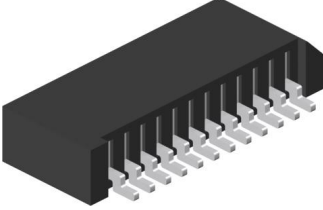
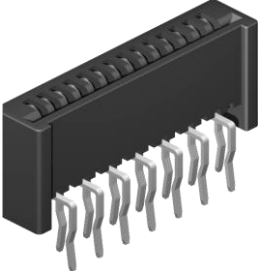
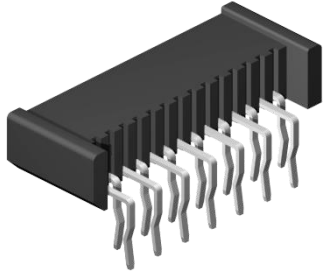
<p>ZIF SMT FPC Type vertical</p>  <p>0.50mm pitch: Page 91 1.00mm pitch: Page 97</p>	<p>ZIF SMT FPC Type horizontal</p>  <p>0.50mm pitch: Page 92 0.80mm pitch: on request 1.00mm pitch: Page 98</p>	<p>ZIF SMT FPC Type horizontal “Easy-on” Type</p>  <p>0.50mm pitch: Page 95</p>
<p>ZIF THT FPC Type straight</p>  <p>1.00mm pitch: Page 101 1.25mm pitch: Page 110</p>	<p>ZIF THT FPC Type right angle</p>  <p>1.00mm pitch: Page 102</p>	<p>LIF SMT FPC/FFC Type vertical</p>  <p>1.00mm pitch: Page 103</p>
<p>LIF SMT FPC/FFC Type horizontal</p>  <p>1.00mm pitch: Page 104 1.25mm pitch: Page 107</p>	<p>LIF THT FPC/FFC Type straight</p>  <p>1.00mm pitch: Page 105 1.25mm pitch: Page 108 2.54mm pitch: Page 111</p>	<p>LIF THT FPC/FFC Type right angle</p>  <p>1.00mm pitch: Page 106 1.25mm pitch: Page 109 2.54mm pitch: Page 112</p>

FLEX CABLE

ZIF Test Sockets for FLEX CABLE

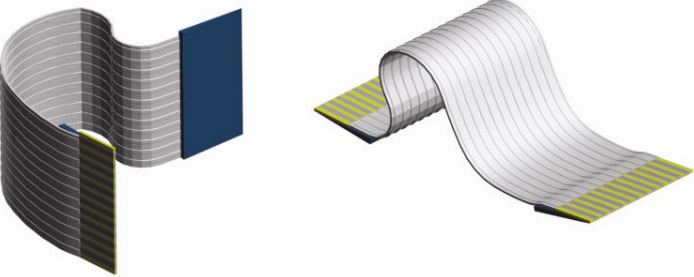
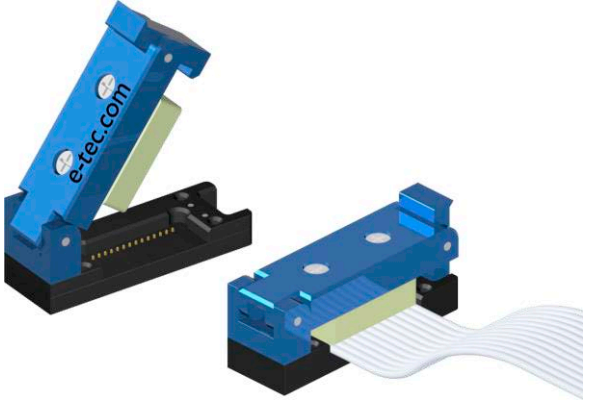
 <p>Pitch: 0.50mm - 0.80mm - 1.00mm - 1.25mm - 1.27mm - 2.00mm - 2.54mm Page 113</p>	 <p>Available for pitch 0.50mm to 2.54mm Page 114</p>
---	--

WIRE TO BOARD CRIMP CONNECTORS

1.00mm pitch Types

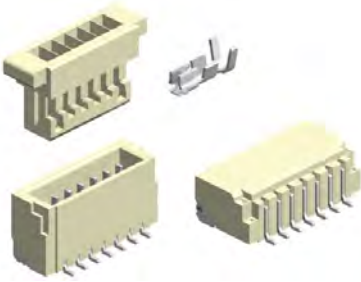

Page 123

1.25mm pitch Types

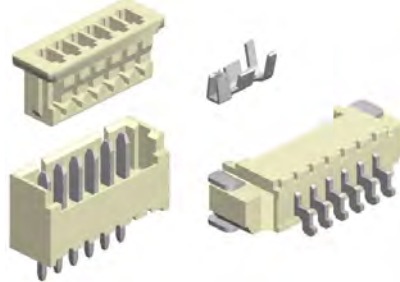

Page 124

1.50mm pitch Types

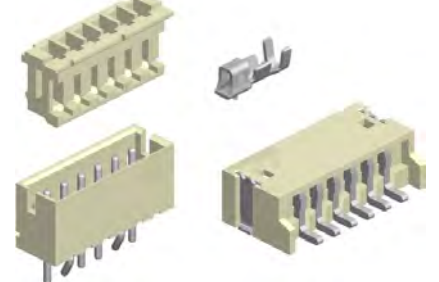

Page 124A

2.00mm pitch Types

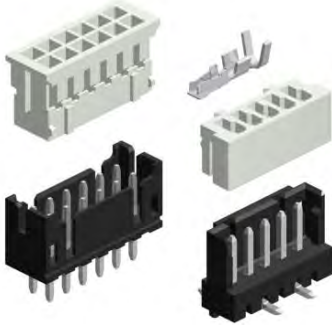

Page 125, 126 & 126-1

2.50mm pitch Types



Page 127

2.54mm Types

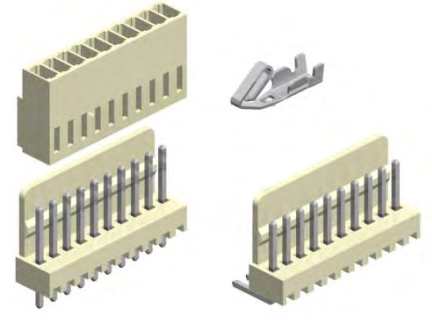

Page 128 & 129

WIRE TO BOARD POWER CONNECTORS

3.00mm Types

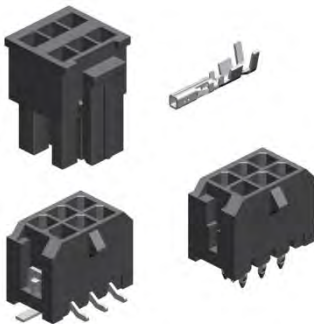

Page 130, 130-1 to 130-4

3.96mm Types

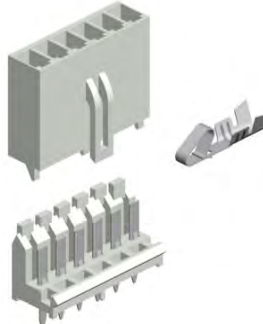

Page 131

4.20mm Types

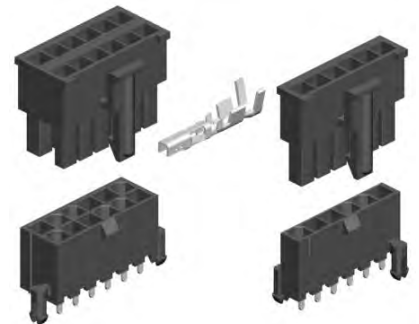

Page 132, 133, 133-1 & 133-2

5.08mm Types

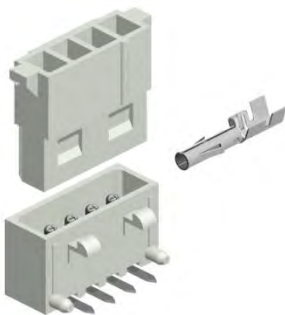

Page 134 & 135 (OBSOLETE)

6.35mm Types

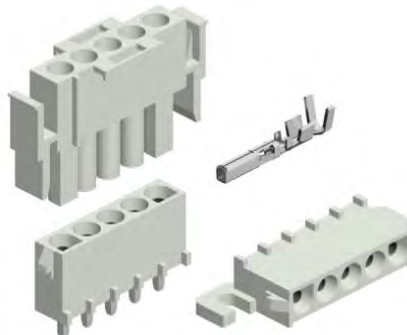

Page 136 & 136-1

Fine Pitch Plug-Board Connectors

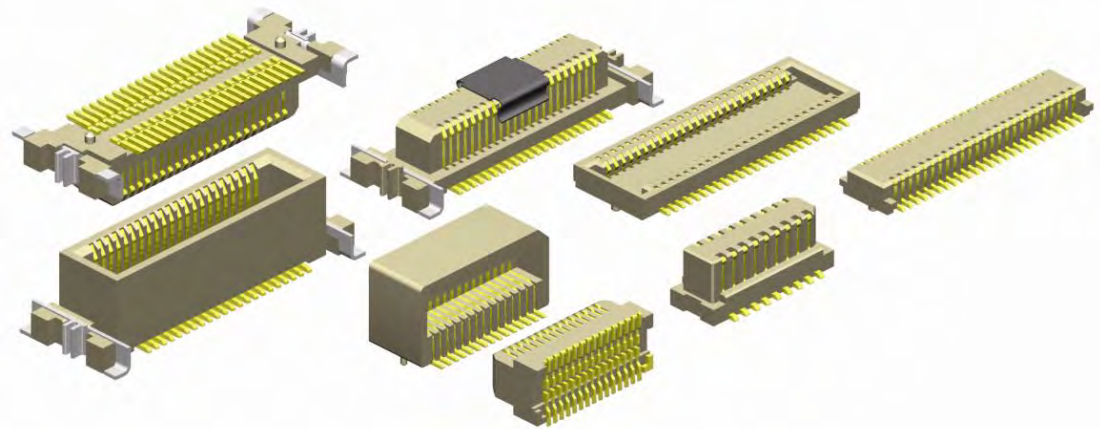

Fine pitch board-to-board connectors allow high density low profile PCB interconnections. These connectors are generally not designed for high insertion/extraction cycles but for one time interconnection, with a possibility to disconnect a limited number of times (around 5 times) during the life time of the product for maintenance purposes only.

Due to the very large variety of design requirements (pincount, board height, pitch, soldertabs, etc) these fine pitch board-to-board connectors are being presented with the following generic E-tec datasheet which allows to highlight the specific project requirements. Based on this information, our production will be able to determine if the current toolings can be adjusted to your requirements and/or if new toolings need to be set-up or if any other close equivalents can be offered as an alternative.

Plug-Board Connector - SMT -

0.50mm - 0.60mm - 0.80mm Pitch



- Fine pitch, super low profile, from 1.50mm to 9.50mm between the boards
- The stamped, solid contacts assure reliable PC Board connections
- Tube or Reel packing available
- Also available with "locating pegs" for easy positioning of the connector during placement
- Some types can also be offered with metal solder tabs, which provide additional mechanical strength to avoid damages to the solder joints during disconnection of the male & female connectors.

Please inform us of your application and precise requirements, so that our product engineers may offer you a suitable solution.

Please indicate your dimensional requirements for the 0.50mm 0.60mm 0.80mm pitch „Plug-Board“ connector. Solutions **without** metal solder tabs, but with & without locating pegs.

Number of contacts in total

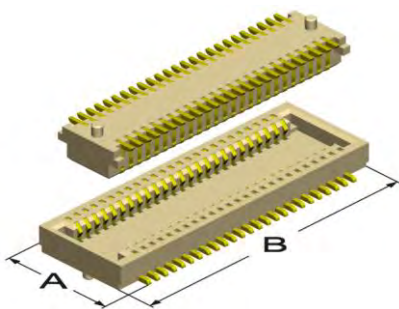

Dimension „A“ (max.):
Dimension „B“ (max.):

Please indicate your dimensional requirements for the 0.50mm 0.60mm 0.80mm pitch „Plug-Board“ connector. Solutions **with** metal solder tabs, but with & without locating pegs.

Number of contacts in total

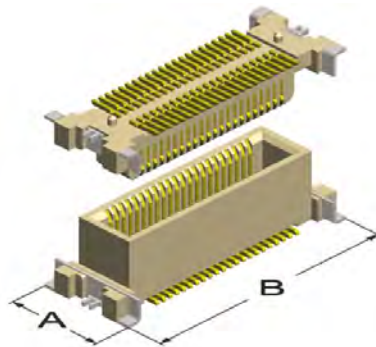

Dimension „A“ (max.):
Dimension „B“ (max.):

Please indicate your dimensional requirements for the 0.50mm 0.60mm 0.80mm pitch right angle type „Plug-Board“ connector. Solutions **without** metal solder tabs, but with & without locating pegs.

Number of contacts in total

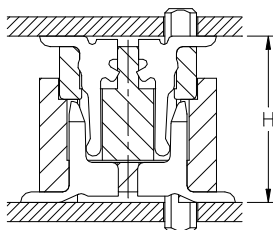
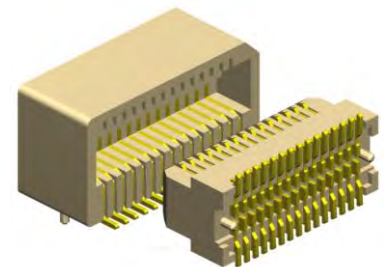

Your board-to-board requirement
Dimension „H“:
Do you wish to receive this connector with or without locating peg?

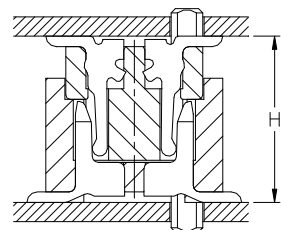

Your board-to-board requirement
Dimension „H“:
Do you wish to receive this connector with or without locating peg?

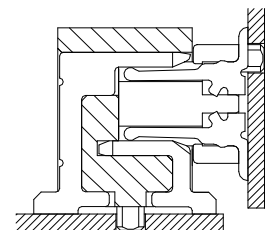

Do you wish to receive this connector with or without locating peg?

In addition, please also provide the following information:

For which application do you intend to use our fine pitch „Plug Board“ Connector?

.....

Please indicate your quantity requirement for „prototypes“ and **„production“**

Please also indicate the expected „life time“ of your project

Your Company Name & Address:

Your Name, Phone, FAX & e-mail

Please FAX this page to the nearest E-tec sales office and we will get back to you as soon as possible with a solution adapted to your needs.

Specifications for E-tec fine pitch Plug Board Connectors

Current rating	0,3 A	Operating temperature	-45°C to +125°C
Insulation resistance	500 MΩ min. at 100 V DC	Processing temperature	+230°C for 60 sec. max. +260°C for 10 sec. max.
Contact resistance	50 mΩ max. at 100 mA	Contact material	Phosphor Bronze
Withstanding voltage	150 V AC 1 minute	Insulator material	Hi Temp Plastic UL 94 V-0

Board to Board & Wire to Board Connectors

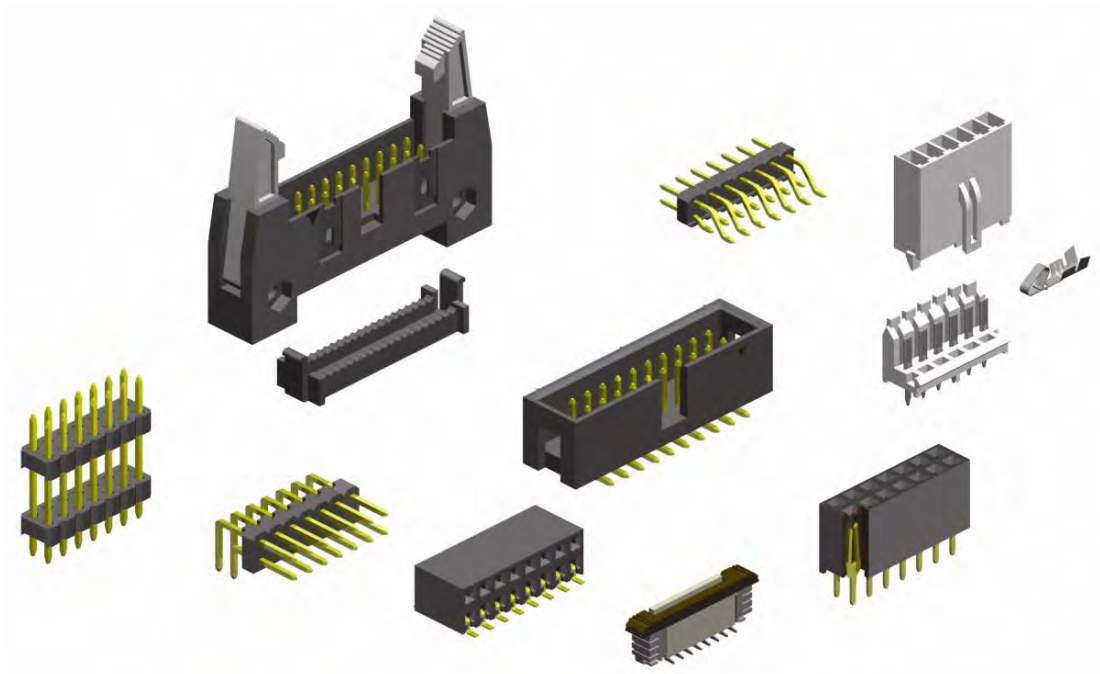

E-tec offers a very large variety of board-to-board and wire-to-board connectors, which take care of nearly all requirements a customer may have in terms of required board connections.

The male/female board-to-board connectors are available in 1.00mm, 1.27mm, 2.00mm and 2.54mm pitch. For the wire-to-board connectors the available pitches start from 0.50mm upwards. The following catalog pages show the standard connector designs, but many other pin lengths or custom designs can be offered on request.

1.00mm pitch Pin Header
- THT - dual row straight

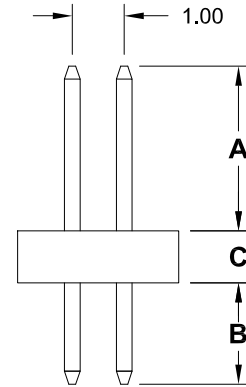
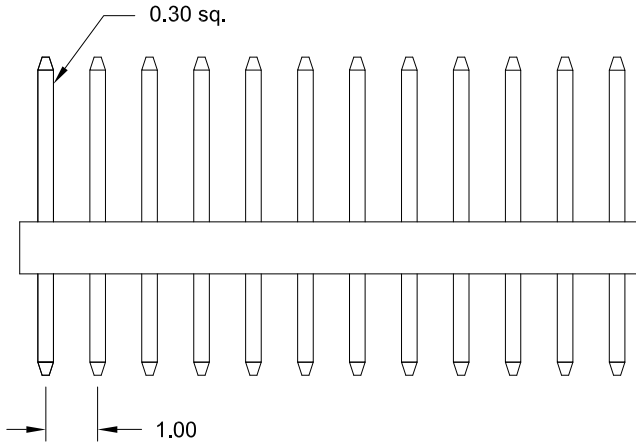
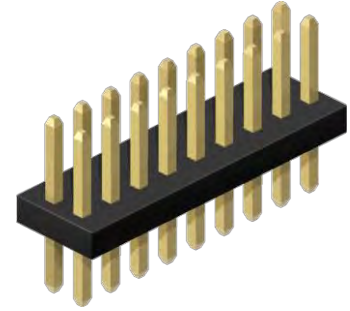
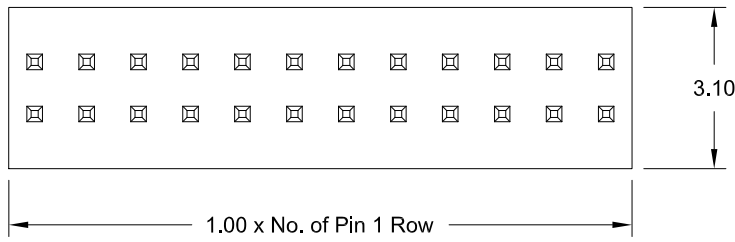

Specifications

Current rating	1 A
Insulation resistance	1000 MΩ min.
Withstanding voltage	500 V AC
Operating temperature	- 40°C to +105°C
Contact material	(RoHS compliant) Copper Alloy
Insulator material	(RoHS compliant) PA9T UL 94 V-0

PCB Hole Layout

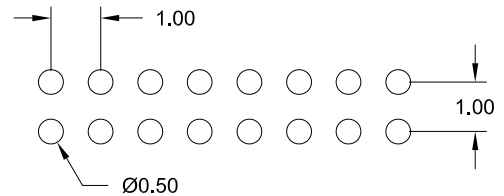

How to order

SL2 - xxx - S xxx/x - 55/00

Nbr of pins
004 to 080

Pin code	DIM "A"	DIM "B"	DIM "C"
050/1	2.00 mm	2.00 mm	1.00 mm
050/2	3.20 mm	2.30 mm	1.00 mm
050/3	3.00 mm	2.30 mm	1.00 mm
112/1	6.50 mm	3.20 mm	1.50 mm
other dimensions on request			

Plating
55 = Gold
other platings on request

1.00mm pitch Pin Header
 - SMT - low profile dual row

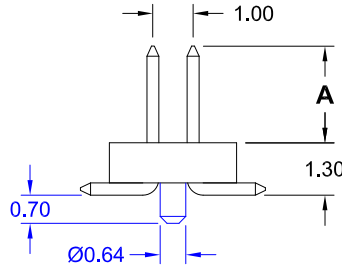
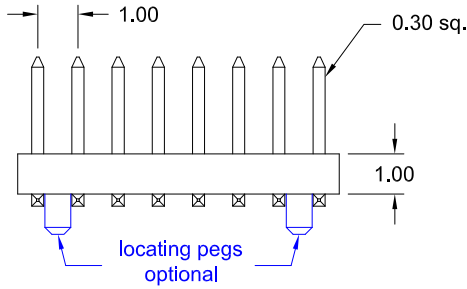
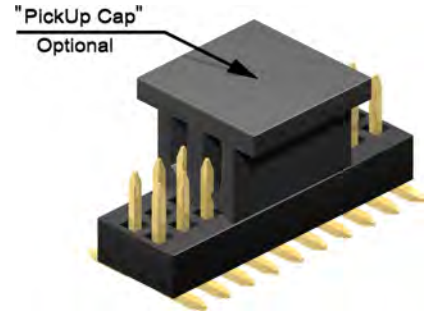
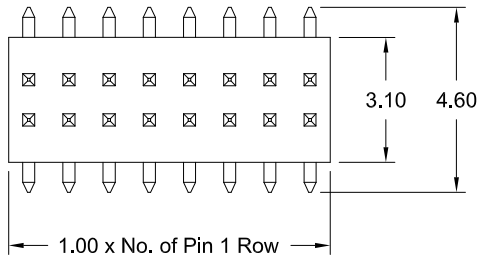

Application and Features

- **Standard: Tube packing, without "locating pegs" and without "PickUp Cap"**
- Assures reliable PC Board connections
- Fine pitch, low profile type with 0.30mm square pin
- Mate with Female Header BS2-xxx-H222-55/00X then "board to board" distance 3.60mm

PCB Surface Mount Layout

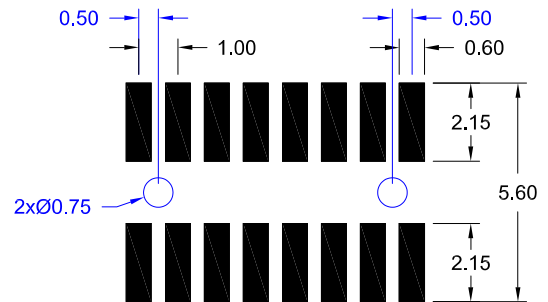

Specifications

Current rating	1 A
Insulation resistance	1000 MΩ min.
Withstanding voltage	500 V AC

Operating temperature	- 40°C to +105°C
Processing temperature	+250°C +0/-5°C for 5sec.
Contact material	(RoHS compliant) Copper Alloy
Insulator material	(RoHS compliant) PA9T UL 94 V-0

How to order

SS2 - xxx - H 18/x - 55/00 X

Nbr of pins	Pin code	DIM "A"	Plating	Options
008 to 100	18/0	1.90 mm	55 = Gold	without "locating pegs"
	18/1	2.40 mm		A = Tube packing; with „PickUp Cap“
	18/2	1.65 mm		B = Reel packing; with „PickUp Cap“
	18/3	5.40 mm		with "locating pegs"
	18/4	3.00 mm	other platings on request	C = Tube packing; without „PickUp Cap“
				D = Tube packing; with „PickUp Cap“
				E = Reel packing; with „PickUp Cap“

1.00mm pitch Board Spacer

- SMT - dual row

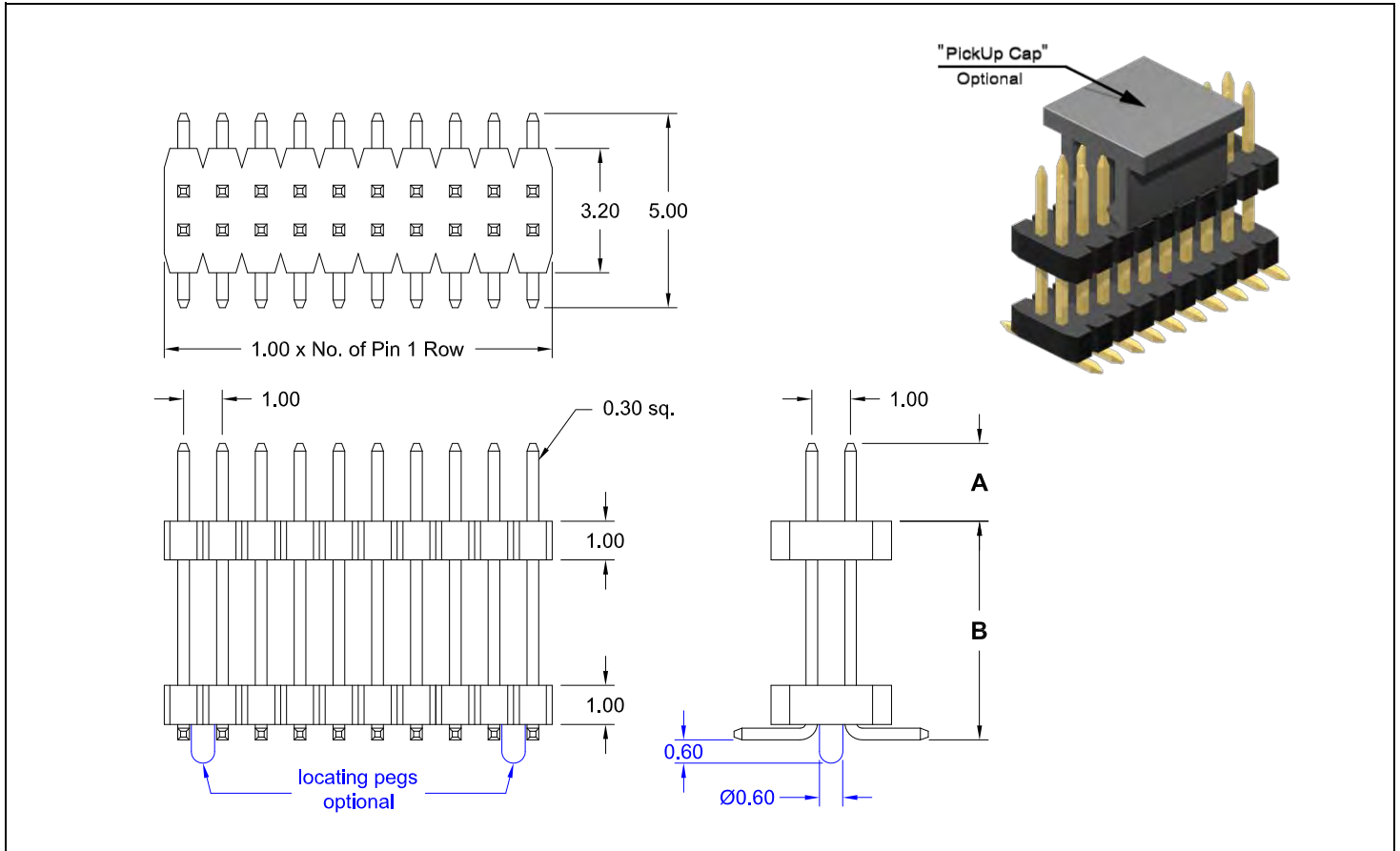

Specifications

Current rating	1 A
Insulation resistance	1000 MΩ min.
Withstanding voltage	500 V AC
Operating temperature	- 40°C to +105°C
Processing temperature	+250°C +0/-5°C for 5sec.
Contact material	(RoHS compliant) Copper alloy
Insulator material	(RoHS compliant) PA9T UL 94 V-0

PCB Surface Mount Layout

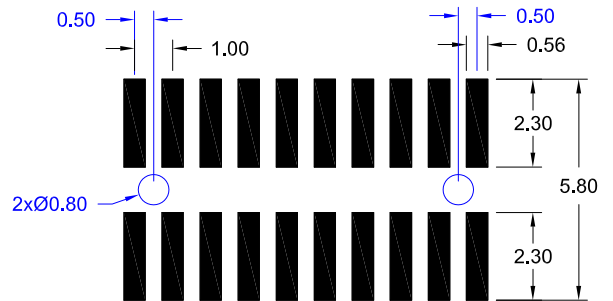

How to order

SP2 - xxx - H 51/x - 55/00 X

Nbr of pins	Pin code	DIM "A"	DIM "B"	Plating	Options
002 to 100	51/0	2.00 mm	7.80 mm	55 = Gold	without "locating pegs" A = Tube packing; with „PickUp Cap“ B = Reel packing; with „PickUp Cap“
	51/1	2.00 mm	5.80 mm		
	51/2	2.00 mm	9.70 mm	other platings on request	with "locating pegs" C = Tube packing; without „PickUp Cap“ D = Tube packing; with „PickUp Cap“ E = Reel packing; with „PickUp Cap“
	51/3	2.00 mm	3.70 mm		
	51/4	2.00 mm	14.00 mm		
	51/5	2.00 mm	6.30mm		
	51/6	2.00 mm	17.00 mm		
other dimensions on request					

1.00mm pitch Female Header
 - SMT - low profile dual row

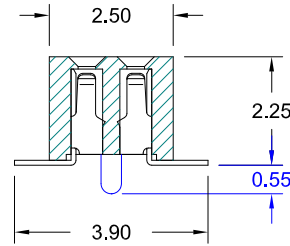
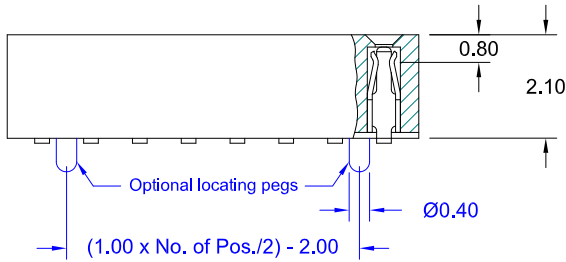
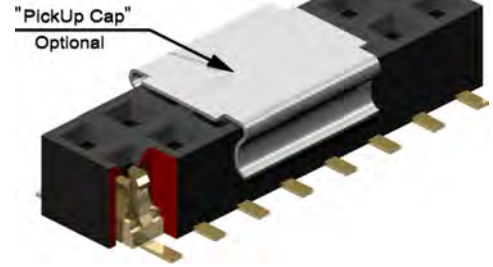
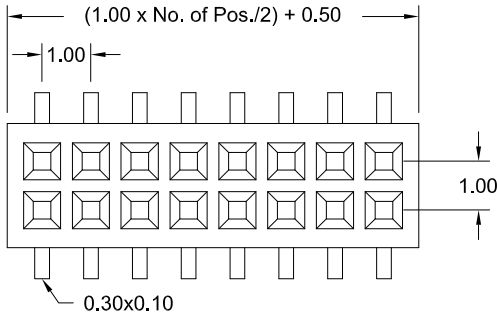

Application and Features

- **Standard: Tube packing, without "locating pegs" and without "PickUp Cap"**
- Assures reliable PC Board connections
- Fine pitch, low profile for space saving Application
- Accept 0.30mm square Pin Header

PCB Surface Mount Layout

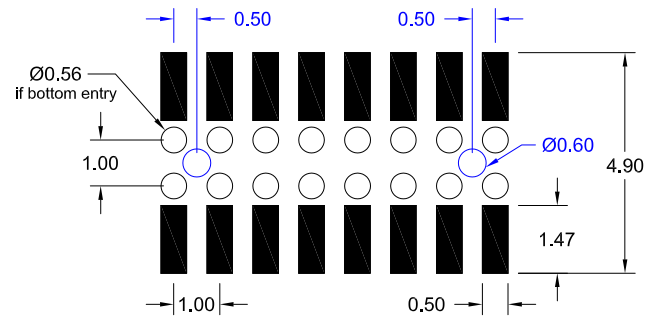

Specifications

Current rating	1 A
Insulation resistance	100 MΩ min.
Contact resistance	20 mΩ max.
Withstanding voltage	500 V AC

Operating temperature	- 40°C to +105°C
Processing temperature	+250°C +0/-5°C for 5sec.
Contact material	(RoHS compliant) Phosphor Bronze
Insulator material	(RoHS compliant) LCP UL 94 V-0

How to order

BS2 - xxx - H222 - 55/00X

Nbr of contacts
without "locating pegs" 004 to 068
with "locating pegs" 008 to 068

Plating
55 = Gold
other platings on request

Options
without "locating pegs"
A = Tube packing; with „PickUp Cap“
B = Reel packing; with „PickUp Cap“
with "locating pegs"
C = Tube packing; without „PickUp Cap“
D = Tube packing; with „PickUp Cap“
E = Reel packing; with „PickUp Cap“

1.27mm pitch Pin Header
 - THT - single row straight

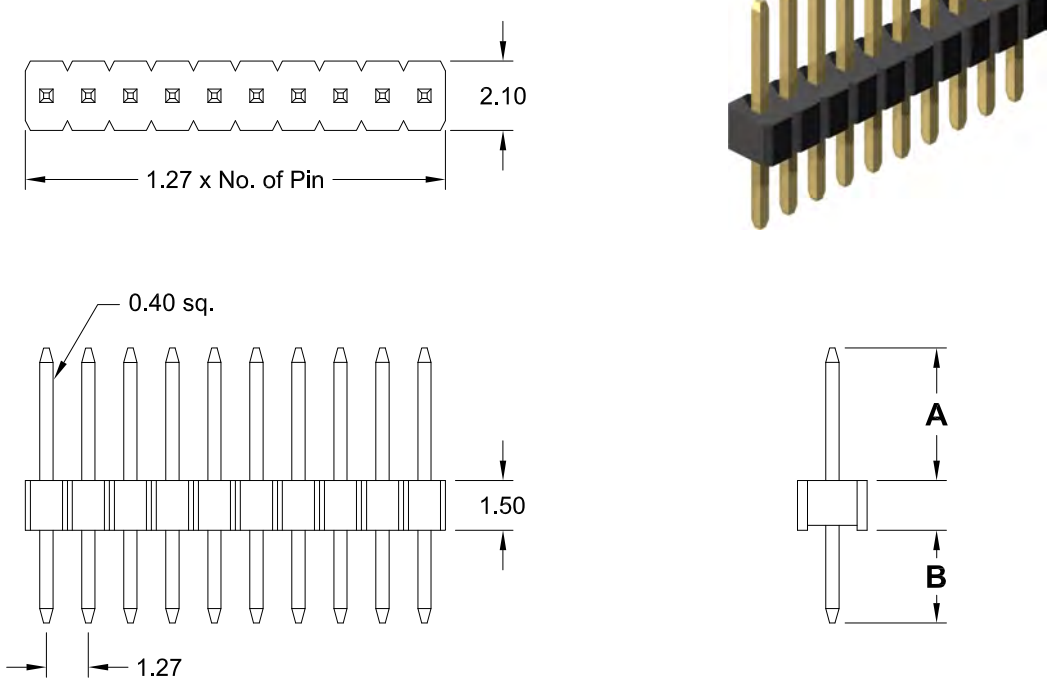

Specifications

Current rating	1 A
Insulation resistance	1000 MΩ min.
Withstanding voltage	500 V AC
Operating temperature	- 40°C to +105°C
Contact material	(RoHS compliant) Copper alloy
Insulator material	(RoHS compliant) PA6T UL 94 V-0

PCB Hole Layout

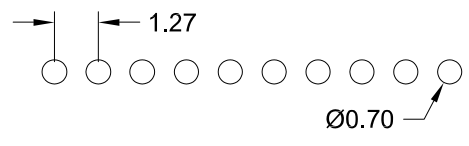

How to order

SL1 - xxx - B xxx/x - 55/11

<p>Nbr of pins</p> <p>002 to 050</p>	<table border="1"> <thead> <tr> <th>Pin code</th> <th>DIM "A"</th> <th>DIM "B"</th> </tr> </thead> <tbody> <tr><td>083/0</td><td>4.00 mm</td><td>2.80 mm</td></tr> <tr><td>083/1</td><td>1.70 mm</td><td>2.40 mm</td></tr> <tr><td>083/2</td><td>3.90 mm</td><td>3.90 mm</td></tr> <tr><td>083/3</td><td>4.50 mm</td><td>2.80 mm</td></tr> <tr><td>083/4</td><td>3.00 mm</td><td>3.00 mm</td></tr> <tr><td>083/5</td><td>8.90 mm</td><td>7.60 mm</td></tr> <tr><td>083/6</td><td>3.00 mm</td><td>2.30 mm</td></tr> <tr><td>083/7</td><td>3.60 mm</td><td>2.80 mm</td></tr> <tr><td>083/8</td><td>3.00 mm</td><td>2.80 mm</td></tr> <tr> <td colspan="3" style="text-align: center;">other dimensions on request</td> </tr> </tbody> </table>	Pin code	DIM "A"	DIM "B"	083/0	4.00 mm	2.80 mm	083/1	1.70 mm	2.40 mm	083/2	3.90 mm	3.90 mm	083/3	4.50 mm	2.80 mm	083/4	3.00 mm	3.00 mm	083/5	8.90 mm	7.60 mm	083/6	3.00 mm	2.30 mm	083/7	3.60 mm	2.80 mm	083/8	3.00 mm	2.80 mm	other dimensions on request			<p>Plating</p> <p>55 = Gold</p> <p>other platings on request</p>
Pin code	DIM "A"	DIM "B"																																	
083/0	4.00 mm	2.80 mm																																	
083/1	1.70 mm	2.40 mm																																	
083/2	3.90 mm	3.90 mm																																	
083/3	4.50 mm	2.80 mm																																	
083/4	3.00 mm	3.00 mm																																	
083/5	8.90 mm	7.60 mm																																	
083/6	3.00 mm	2.30 mm																																	
083/7	3.60 mm	2.80 mm																																	
083/8	3.00 mm	2.80 mm																																	
other dimensions on request																																			

Style S063/x & S064/x

Style S081/x

PCB Hole Layout

PCB Hole Layout

Specifications

Current rating	1 A	Operating temperature	- 40°C to +105°C
Insulation resistance	1000 MΩ min.	Contact material	Copper Alloy (RoHS compliant)
Withstanding voltage	500 V AC	Insulator material	PA6T UL 94 V-0 (RoHS compliant)

How to order

SL x - xxx - S xxx/x - 55/11

Rows	Nbr of pins	Pin code	DIM "A"	DIM "B"	DIM "C"	Plating
1 = single row	002 to 050	063/1	3.00 mm	2.30 mm	1.00 mm	55 = Gold other platings on request
		063/2	7.00 mm	2.30 mm	1.00 mm	
		063/3	5.00 mm	2.30 mm	1.00 mm	
		063/4	3.10 mm	1.90 mm	1.00 mm	
		063/5	2.80 mm	2.50 mm	1.00 mm	
		064/0	7.50 mm	5.00 mm	1.50 mm	
Insulator thickness 2.00mm on request.						
		081/1	3.00 mm	2.60 mm	2.50 mm	
		081/2	4.00 mm	2.60 mm	2.50 mm	
		081/3	6.00 mm	2.60 mm	2.50 mm	
other dimensions on request						

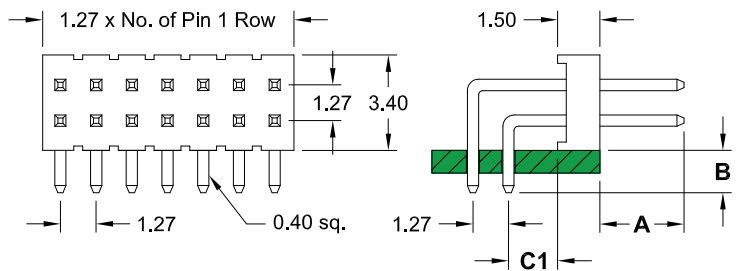
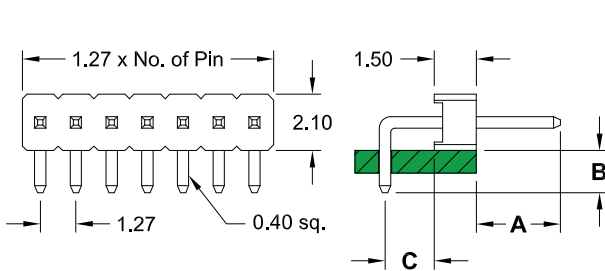
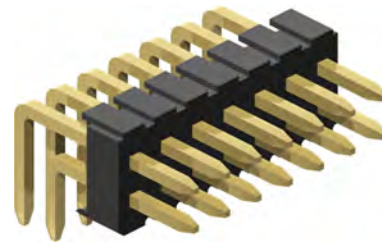
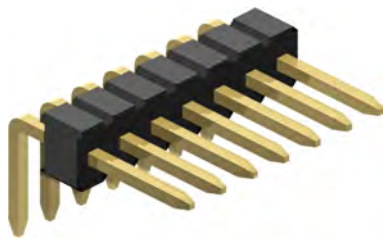

Specifications

Current rating	1 A
Insulation resistance	1000 MΩ min.
Withstanding voltage	500 V AC
Operating temperature	- 40°C to +105°C
Contact material	(RoHS compliant) Copper Alloy
Insulator material	(RoHS compliant) PA6T UL 94 V-0

PCB Hole Layout

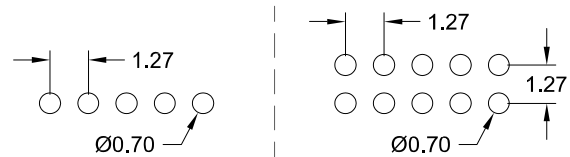

How to order

SL x - xxx - R xxx/x - 55/11

Rows	Nbr of pins	Pin code	DIM "A"	DIM "B"	DIM "C" (1 row)	DIM "C1" (2 row)	Plating
1 = single row	002 to 050	071/0	3.80 mm	3.00 mm	1.50 mm	1.70 mm	55 = Gold other platings on request
		071/1	4.80 mm	2.50 mm	0.80 mm	1.00 mm	
		071/2	3.00 mm	3.00 mm	1.50 mm	1.70 mm	
		071/3	3.80 mm	4.50 mm	1.50 mm	1.70 mm	
		071/4	3.80 mm	1.60 mm	1.50 mm	1.70 mm	
		071/5	3.00 mm	2.80 mm	1.50 mm	1.70 mm	
2 = dual row	006 to 100	071/6	4.00 mm	4.00 mm	1.50 mm	1.70 mm	
		other dimensions on request					

1.27mm pitch Board Spacer

- THT - single & dual row

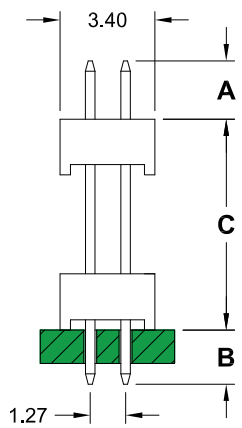
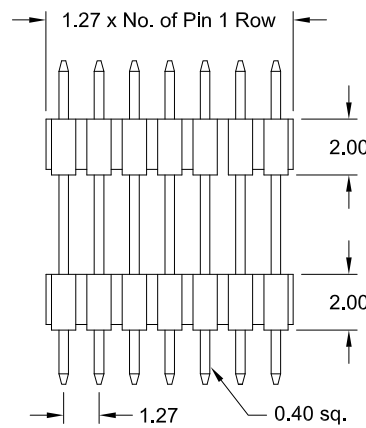
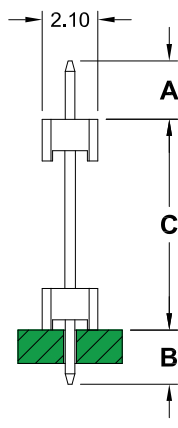
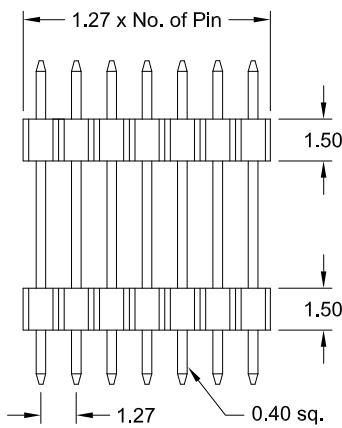
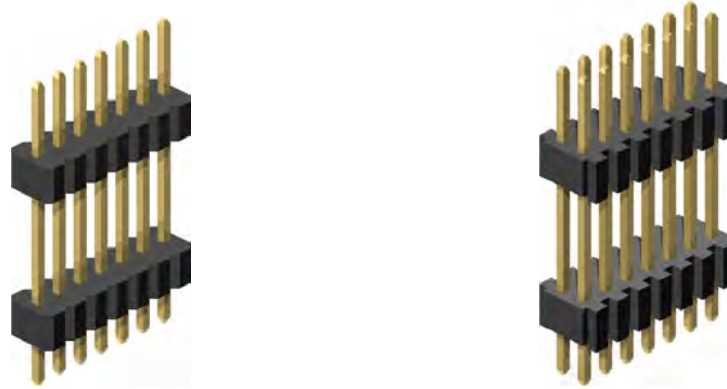

PCB Hole Layout

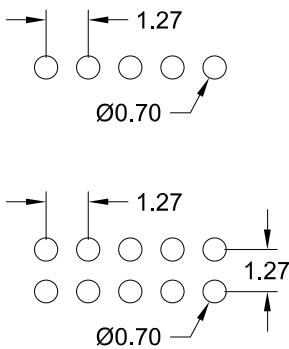

Specifications

Current rating	1 A
Insulation resistance	1000 MΩ min.
Withstanding voltage	500 V AC
Operating temperature	- 40°C to +105°C
Contact material	Copper Alloy <i>(RoHS compliant)</i>
Insulator material	PA6T UL 94 V-0 <i>(RoHS compliant)</i>

Pin code	DIM "A"	DIM "B"	DIM "C"
162/1	5.70 mm	5.70 mm	4.80 mm
179/0	5.85 mm	5.85 mm	6.15 mm
130/2	3.70 mm	2.30 mm	7.00 mm
130/3	3.00 mm	3.00 mm	7.00 mm
150/2	4.00 mm	3.00 mm	8.00 mm
127/1	2.20 mm	2.20 mm	8.30 mm
152/2	3.60 mm	2.60 mm	9.00 mm
180/3	4.00 mm	4.00 mm	10.00 mm
205/1	3.00 mm	6.50 mm	11.00 mm
190/1	3.00 mm	3.00 mm	13.00 mm
220/1	6.00 mm	3.00 mm	13.00 mm
200/1	3.00 mm	3.00 mm	14.00 mm
230/1	3.00 mm	6.00 mm	14.00 mm
210/4	3.50 mm	3.00 mm	14.50 mm
230/2	3.00 mm	3.00 mm	17.00 mm
244/2	4.00 mm	3.00 mm	17.40 mm
265/1	4.60 mm	3.00 mm	18.90 mm

other dimensions on request

How to order

SP x - xxx - S xxx/x - 55/11

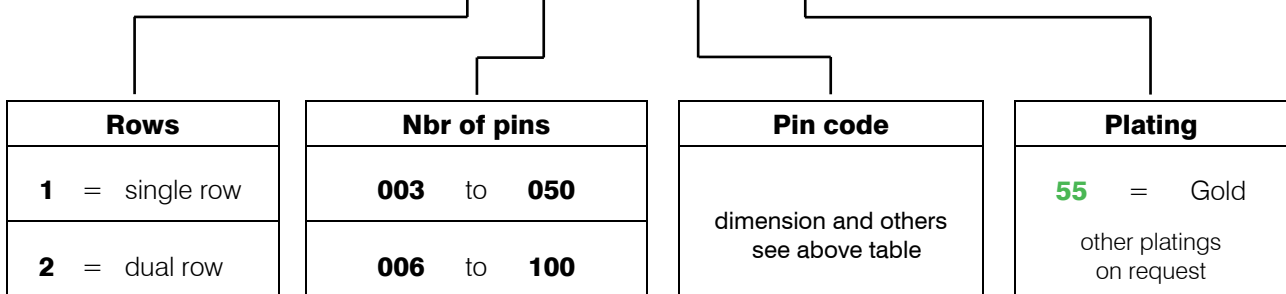

1.27mm Pin Header & Board Spacer

1.27mm x 2.54mm Board Spacer

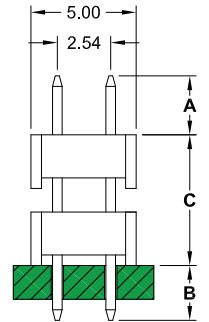
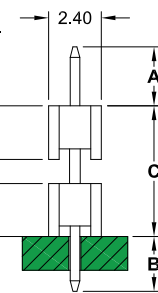
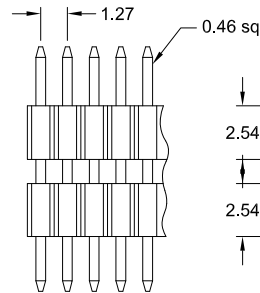
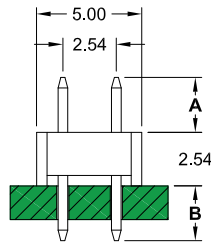
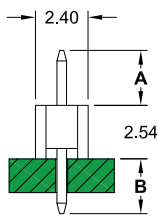
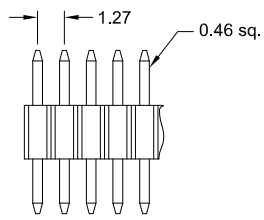

SL1

SL2

SP1

SP2

Specifications

Current rating	1 A
Insulation resistance	1000 MΩ min.
Withstanding voltage	500 V AC
Operating temperature	- 40°C to +105°C
Contact material (RoHS compliant)	Copper Alloy
Insulator material (RoHS compliant)	PA6T UL 94 V-0

PCB Hole Layout

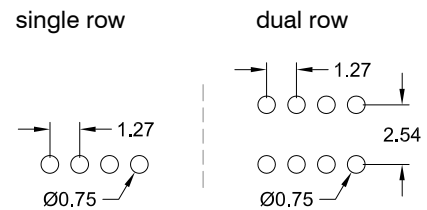

How to order

S xx - xxx - S xxx/xx - **55/1**

Rows single plastic	Nbr of pins	Pin code	DIM "A"	DIM "B"	Plating
L1 = single row	single row = 003 to 050	079/01	2.80 mm	2.60 mm	55 = Gold
L2 = dual row	dual row = 006 to 100	091/02	4.00 mm	2.60 mm	
		111/01	6.00 mm	2.60 mm	
		164/01	2.50 mm	11.40 mm	
		179/01	12.30 mm	3.10 mm	
		other dimensions on request			
Rows Boardspacer	Nbr of pins	Pin code	DIM "A"	DIM "B"	DIM "C"
P1 = single row	single row = 003 to 050	084/01	1.10 mm	1.30 mm	6.00 mm
P2 = dual row	dual row = 006 to 100	116/01	2.80 mm	2.60 mm	6.20 mm
		152/01	6.00 mm	3.00 mm	6.20 mm
		127/01	2.20 mm	2.20 mm	8.30 mm
		137/01	3.00 mm	2.30 mm	8.40 mm
		160/06	3.00 mm	4.00 mm	9.00 mm
		210/06	5.50 mm	2.50 mm	13.00 mm
		218/01	6.00 mm	1.80 mm	14.00 mm
		other dimensions on request			other platings on request

1.27mm pitch Pin Header
 - SMT - low profile dual row

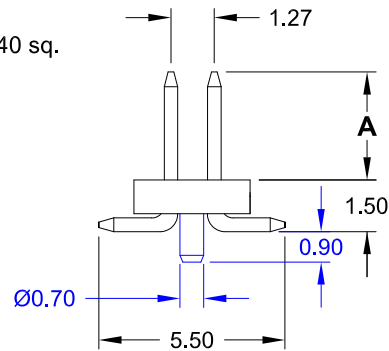
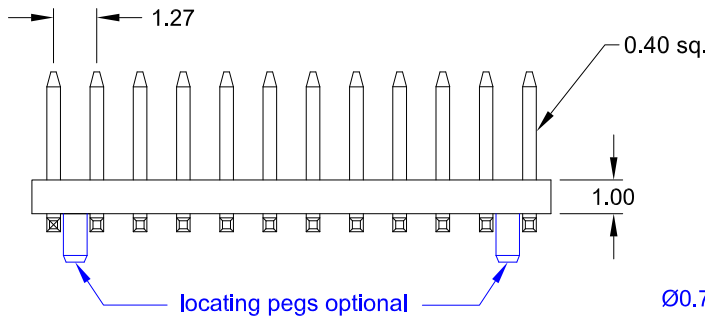
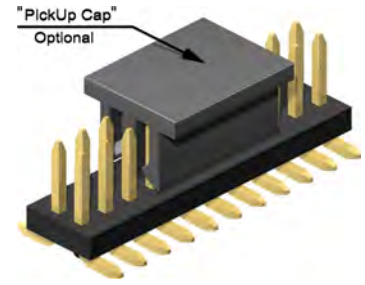
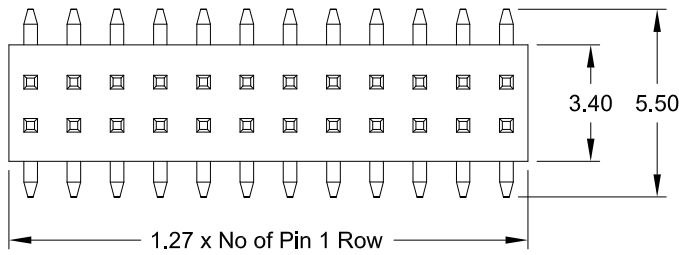

Application and Features

- **Standard: Tube packing, without "locating pegs" and without "PickUp Cap"**
- Assures reliable PC Board connections
- Low profile insulator
- Mates with 1.27mm pitch Female Headers

PCB Surface Mount Layout

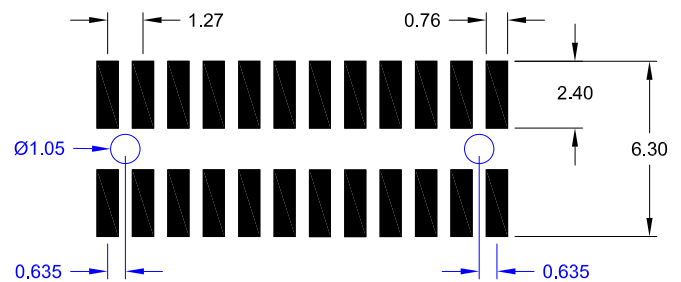

Specifications

Current rating	1 A
Insulation resistance	1000 MΩ min.
Withstanding voltage	500 V AC

Operating temperature	- 40°C to +105°C
Processing temperature	+250°C +0/-5°C for 5sec.
Contact material	(RoHS compliant) Copper Alloy
Insulator material	(RoHS compliant) PA6T UL 94 V-0

How to order

SS2 - xxx - H xx/x - 55/11 X

Nbr of pins	Pin code	DIM "A"	Plating	Options
without locating pegs: 006 to 100	70/0	3.00 mm	55 = Gold other platings on request	without "locating pegs"
with locating pegs: 008 to 100	70/1	10.00 mm		A = Tube packing; with „PickUp Cap“
	70/2	6.50 mm		B = Reel packing; with „PickUp Cap“
	70/3	12.50 mm		with "locating pegs" (available only from 008 to 100 pins)
	70/4	4.00 mm	C = Tube packing; without „PickUp Cap“	
	other dimensions on request		D = Tube packing; with „PickUp Cap“	
			E = Reel packing; with „PickUp Cap“	

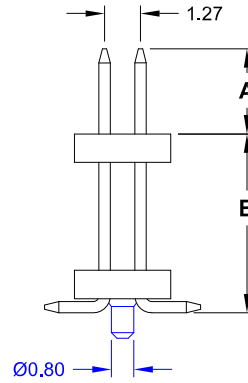
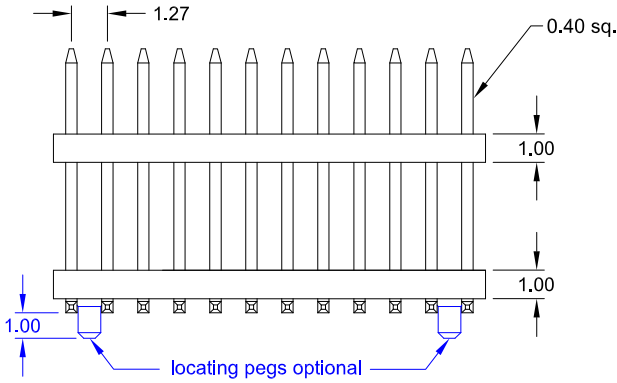
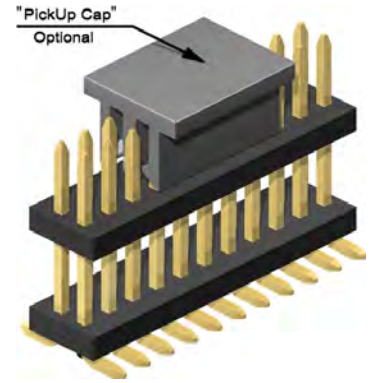
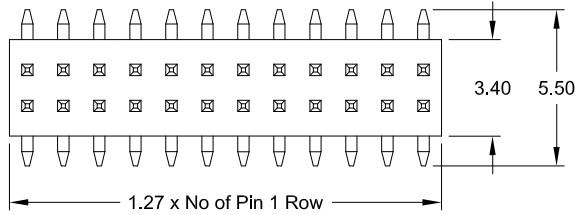

Specifications

Current rating	1 A
Insulation resistance	1000 MΩ min.
Withstanding voltage	500 V AC
Operating temperature	- 40°C to +105°C
Processing temperature	+250°C +0/-5°C for 5sec.
Contact material	(RoHS compliant) Copper alloy
Insulator material	(RoHS compliant) PA6T UL 94 V-0

PCB Surface Mount Layout

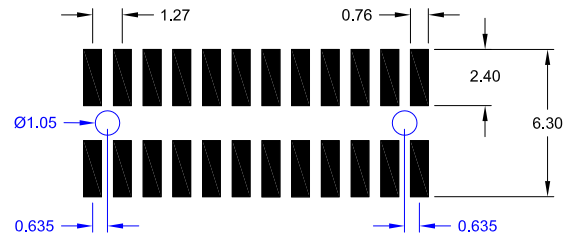

How to order

SP2 - xxx - H xx/x - 55/11 X

Nbr of pins	Pin code	DIM "A"	DIM "B"	Plating	Options
without "locating pegs"	21/9	4.10 mm	2.90 mm	55 = Gold	without "locating pegs"
006 to 100	22/9	5.20 mm	3.80 mm		
with "locating pegs"	21/1	3.00 mm	4.00 mm	other platings on request	A = Tube packing; with „PickUp Cap“ B = Reel packing; with „PickUp Cap“
	22/8	1.50 mm	4.40 mm		
	22/3	5.00 mm	4.50 mm		
	21/2	3.00 mm	5.50 mm		
	22/5	6.00 mm	5.50 mm		
	21/0	3.00 mm	6.00 mm		
	22/0	3.00 mm	7.00 mm		
	22/2	4.70 mm	7.10 mm		
	22/4	4.00 mm	7.50 mm		
	21/8	4.80 mm	7.50 mm		
	23/0	6.10 mm	7.50 mm		
	21/3	5.60 mm	8.00 mm		
	21/7	4.00 mm	8.30 mm		
	21/5	3.00 mm	9.00 mm		
	21/4	3.80 mm	9.65 mm		
	22/1	5.10 mm	10.20 mm		
22/6	3.00 mm	11.50 mm			
22/7	3.00 mm	14.00 mm			
21/6	3.00 mm	16.00 mm			
other dimensions on request					
with "locating pegs" (available only from 008 to 100 pins)					
C = Tube packing; without „PickUp Cap“					
D = Tube packing; with „PickUp Cap“					
E = Reel packing; with „PickUp Cap“					

1.27mm - SMT - Pin Header

dual row 1.27mm x 2.54mm

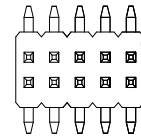
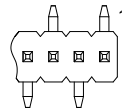
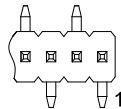
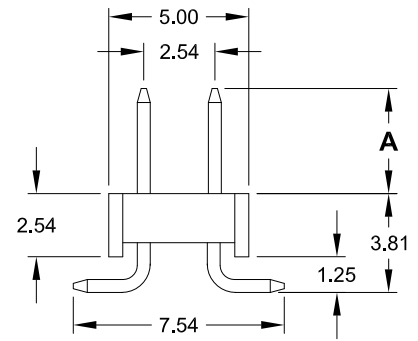
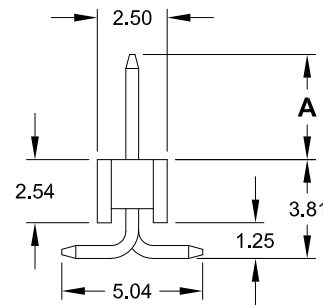
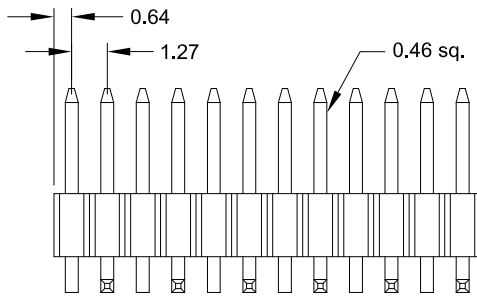
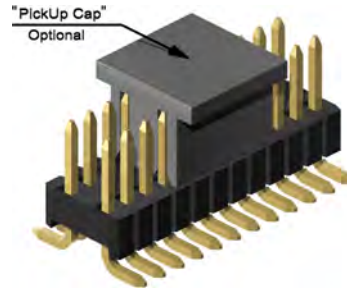
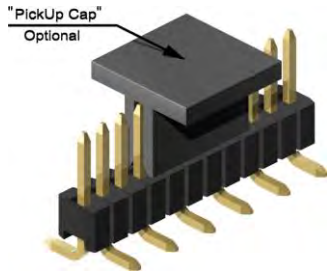

Foot Style:

380

381

380

Specification

Current rating	1 A
Insulation resistance	1000 MΩ min.
Withstanding voltage	500 V AC
Operating temperature	- 40°C to +105°C
Processing temperature	+250°C +0/-5°C for 5sec.
Contact material (RoHS compliant)	Copper Alloy
Insulator material (RoHS compliant)	PA6T UL 94 V-0

PCB Surface Mount Layout

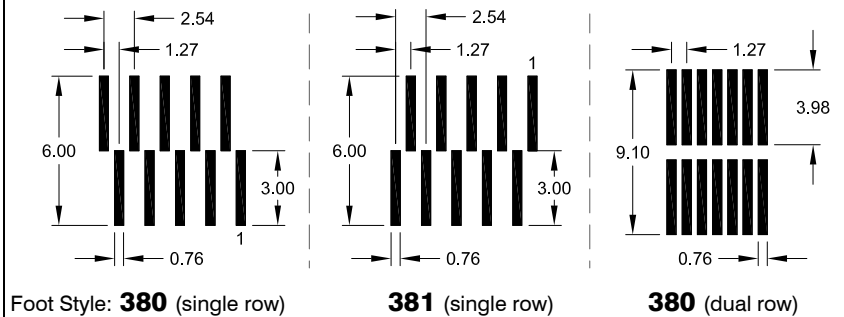

How to order

SS x - xxx - H xxx / x - 55/1 X

Rows	Nbr of pins	Foot Style	Pin code	DIM "A"	Plating	Packing and "PickUp Cap" Option
1 = single row	003 to 050	380	/ 0	2.80 mm	55 = Gold	A = Tube packing; with "PickUp Cap" B = Reel packing; with "PickUp Cap"
		381	/ 0	2.80 mm		
2 = dual row	006 to 100	380	/ 0	2.80 mm	other platings on request	
		380	/ 1	4.50 mm		
		380	/ 2	5.50 mm		
		380	/ 3	4.80 mm		
		other dimensions on request				

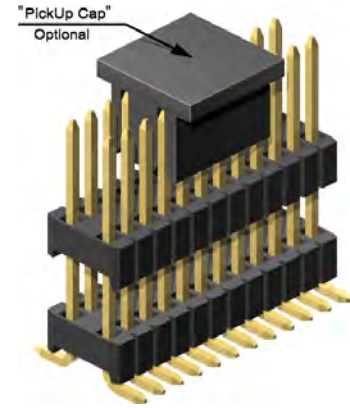
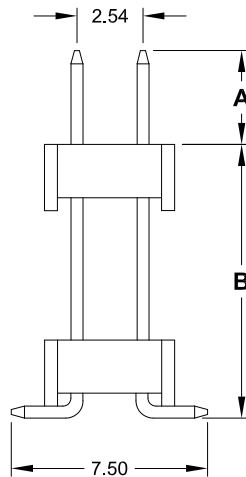
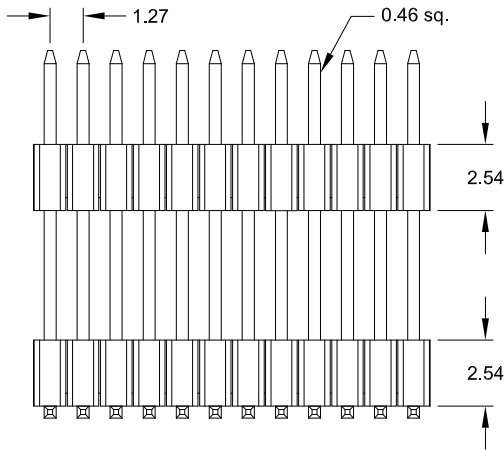
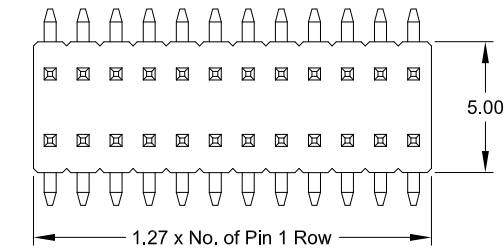

Specifications

Current rating	1 A
Insulation resistance	1000 MΩ min.
Withstanding voltage	500 V AC
Operating temperature	- 40°C to +105°C
Processing temperature	+250°C +0/-5°C for 5sec.
Contact material (RoHS compliant)	Copper Alloy
Insulator material (RoHS compliant)	PA9T UL 94 V-0

PCB Surface Mount Layout

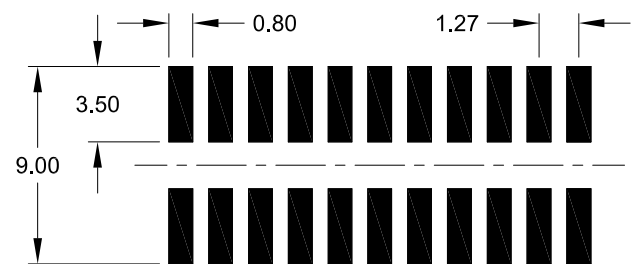

How to order

SP2 - xxx - H 220/x - 55/1 X

Nbr of pins	Pin code	DIM "A"	DIM "B"	Plating	Packing and "PickUp Cap" Option (standard Tube packing; without "PickUp Cap")
006 to 100	220/0	5.60 mm	8.50 mm	55 = Gold	A = Tube packing; with "PickUp Cap" B = Reel packing; with "PickUp Cap"
	220/1	5.60 mm	9.75 mm		
	220/2	3.40 mm	12.00 mm		
	220/3	3.30 mm	6.50 mm		
	220/4	4.00 mm	8.00 mm		
	220/5	6.00 mm	12.00 mm		
	220/6	5.00 mm	12.00 mm		
	other dimensions on request		other platings on request		

1.27mm pitch Box Header
 - THT - straight - raised



<p>Style S535</p>	<p>Style P535</p>														
<p style="text-align: center;">Specifications</p> <table style="width: 100%; border: none;"> <tr> <td style="width: 30%;">Current rating</td> <td>1 A</td> </tr> <tr> <td>Insulation resistance</td> <td>1000 MΩ min.</td> </tr> <tr> <td>Contact resistance</td> <td>20mΩ max.</td> </tr> <tr> <td>Withstanding voltage</td> <td>300 V AC</td> </tr> <tr> <td>Operating temperature</td> <td>- 40°C to +105°C</td> </tr> <tr> <td>Contact material</td> <td>(RoHS compliant) S535: PhBz P535: Brass</td> </tr> <tr> <td>Insulator material</td> <td>(RoHS compliant) LCP UL 94 V-0</td> </tr> </table>	Current rating	1 A	Insulation resistance	1000 MΩ min.	Contact resistance	20mΩ max.	Withstanding voltage	300 V AC	Operating temperature	- 40°C to +105°C	Contact material	(RoHS compliant) S535: PhBz P535: Brass	Insulator material	(RoHS compliant) LCP UL 94 V-0	<p style="text-align: center;">PCB Hole Layout</p>
Current rating	1 A														
Insulation resistance	1000 MΩ min.														
Contact resistance	20mΩ max.														
Withstanding voltage	300 V AC														
Operating temperature	- 40°C to +105°C														
Contact material	(RoHS compliant) S535: PhBz P535: Brass														
Insulator material	(RoHS compliant) LCP UL 94 V-0														
<p>Application and Features</p> <p>Mating with 1.27mm pitch Female Headers BS2-xxx-H45B- & -H45P-55/11 (page 33) as “board to board” connection.</p> <p>No ejection latches for space saving</p>															

How to order

SLS - xxx - Xxxx - 55/11

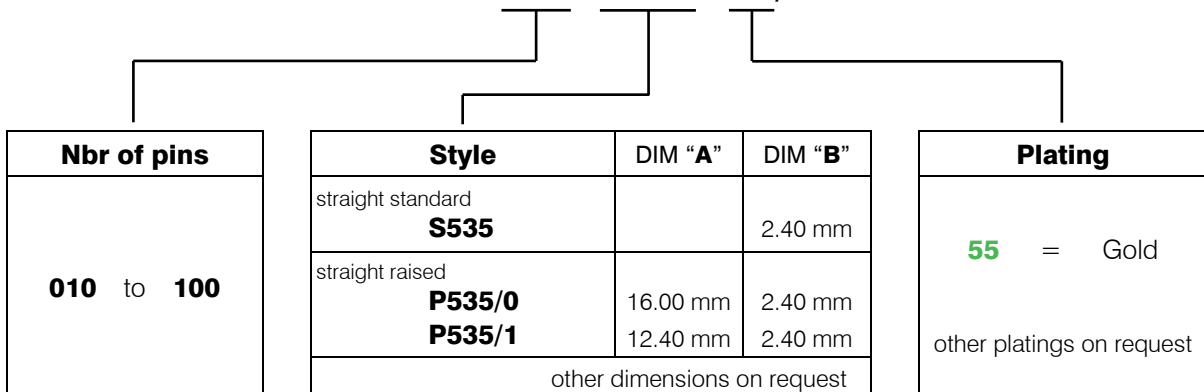

1.27mm pitch Box Header
 - THT - right angle

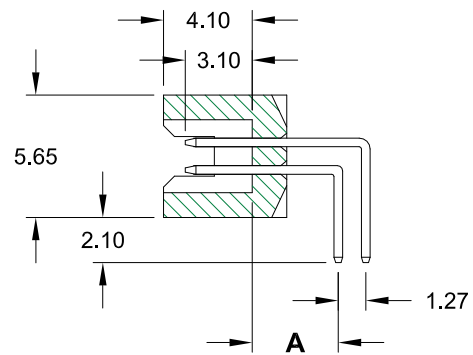
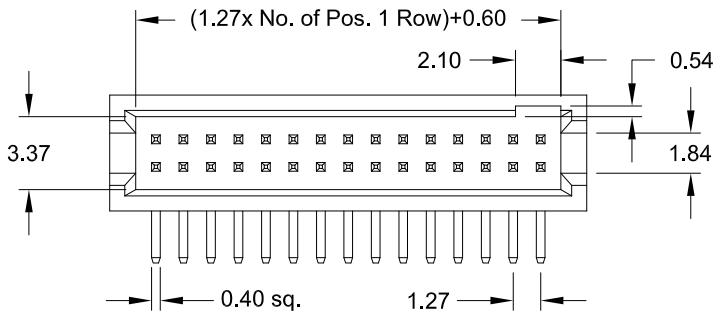
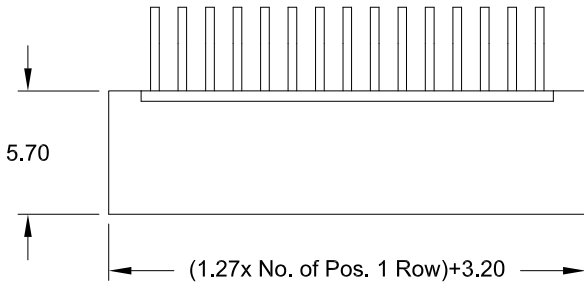

Specifications

Current rating	1 A
Insulation resistance	1000 MΩ min.
Contact resistance	20 mΩ max.
Withstanding voltage	300 V AC
Operating temperature	- 40°C to +105°C
Contact material	(RoHS compliant) Copper Alloy
Insulator material	(RoHS compliant) LCP UL 94 V-0

PCB Hole Layout

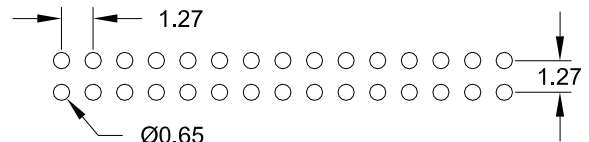

Application and Features

Mating with 1.27mm pitch Female Headers BS2-xxx-H45B- & -H45P-55/11 (page 33) as “board to board” connection.

No ejection latches for space saving.

How to order

SLS - xxx - R xxx/x - 55/11

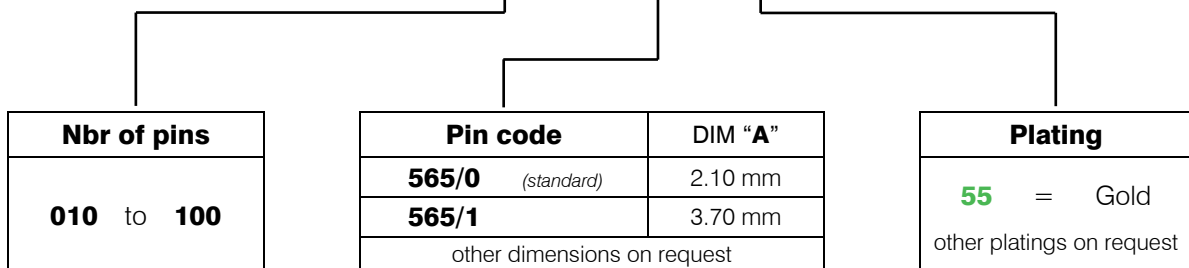



Style **H610**

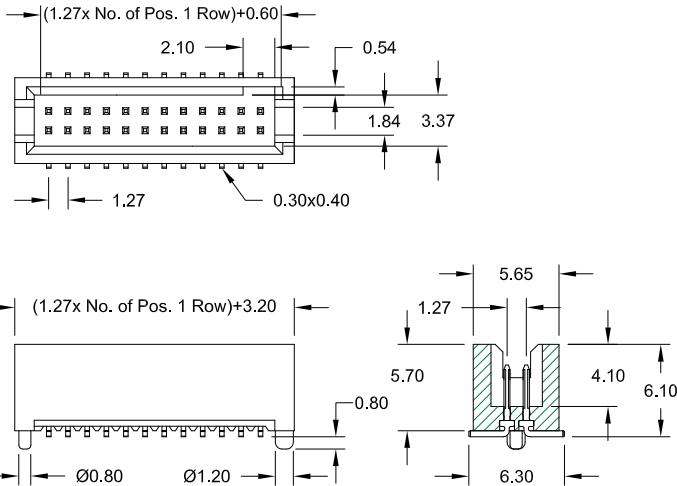

Style **HPxx**

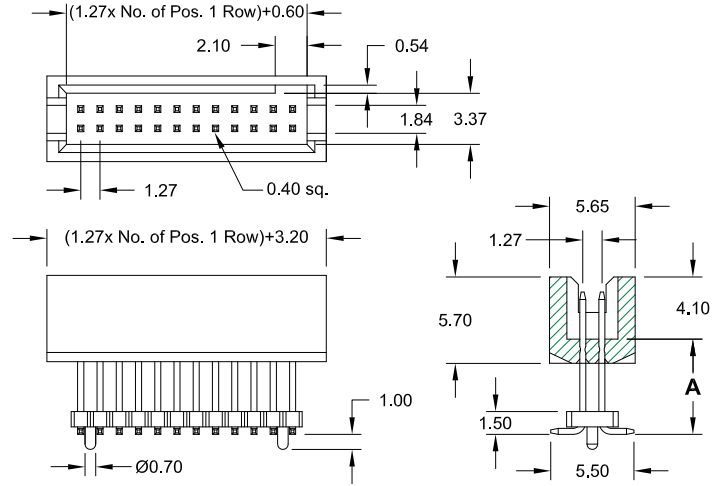
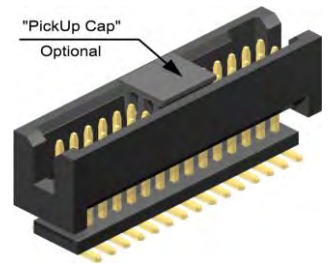

PCB Surface Mount Layout

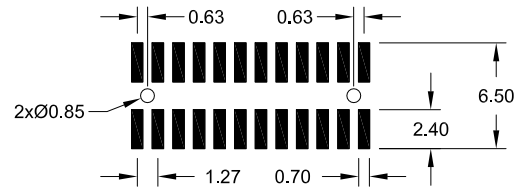
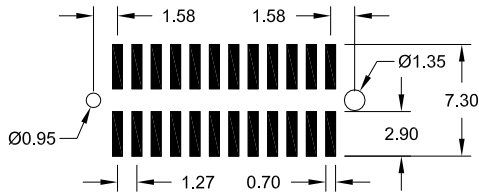

Specifications

Current rating	1 A	Operating temperature	- 40°C to +105°C
Insulation resistance	1000 MΩ min.	Processing temperature	+250°C +0/-5°C for 5sec.
Contact resistance	20 mΩ max.	Contact material	(RoHS compliant) Phosphor Bronze
Withstanding voltage	300 V AC	Insulator material	(RoHS compliant) LCP UL 94 V-0

Application and Features

Mating with 1.27mm pitch Female Headers BS2-xxx-H45B- & -H45P-55/11 (page 33) as "board to board" connection.

No ejection latches for space saving.

How to order

SLS - xxx - Xxxx - 55/11 X

Nbr of pins	Style	Plating	Packing Option	
010 to 100	H610 Low Profile	55 = Gold other platings on request	D = Tube packing; with "PickUp Cap" E = Reel packing; with "PickUp Cap"	
	Raised Type			DIM "A"
	HP20			15.00 mm (standard)
	HP21			18.00 mm
	HP22			8.50 mm
	other dimensions on request			

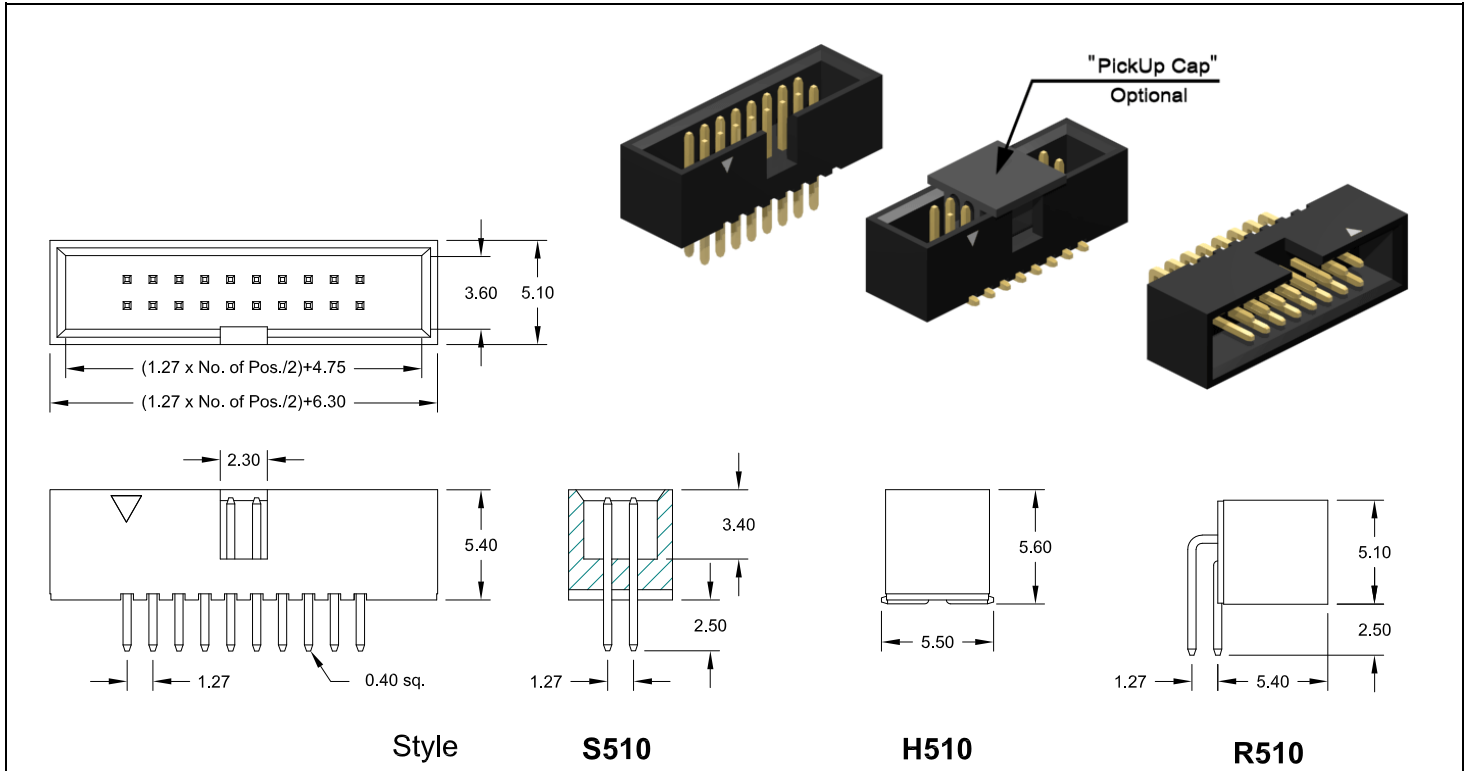

Application and Features

- **Standard:**
Tray packing for S510 & R510 Style
Tube packing for H510 Style
- Designed to mate with IDC female connector IDS-xxx-W050-55/P
- Reliable flat cable to PCB connection
- No ejection latches for space saving

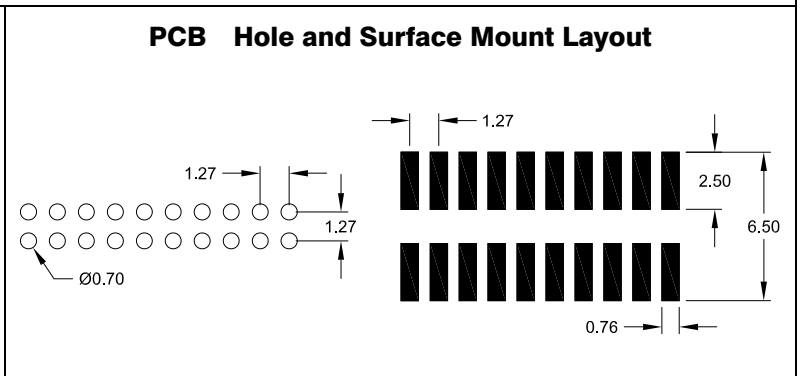

Specifications

Current rating	1 A	Operating temperature	- 40°C to +105°C
Insulation resistance	1000 MΩ min.	Processing temperature (SMT)	+250°C +0/-5°C for 5sec.
Withstanding voltage	500 V AC	Contact material (RoHS compliant)	Copper Alloy
		Insulator material (RoHS compliant)	LCP UL 94 V-0

How to order

SLS - xxx - X 510 - 55/11 (X)

Nbr of pins	Pin Style	Plating	Option only for - H510 - Style
010; 012; 014; 016 020; 024; 026; 028 030; 034; 040; 044 050; 060; 064; 068 080; 100	S = straight R = right angle H = SMT	55 = Gold other platings on request	A = Tube packing; with "PickUp Cap" B = Reel packing; with "PickUp Cap"

1.27mm pitch Female Header
 - THT - dual row straight & right angle

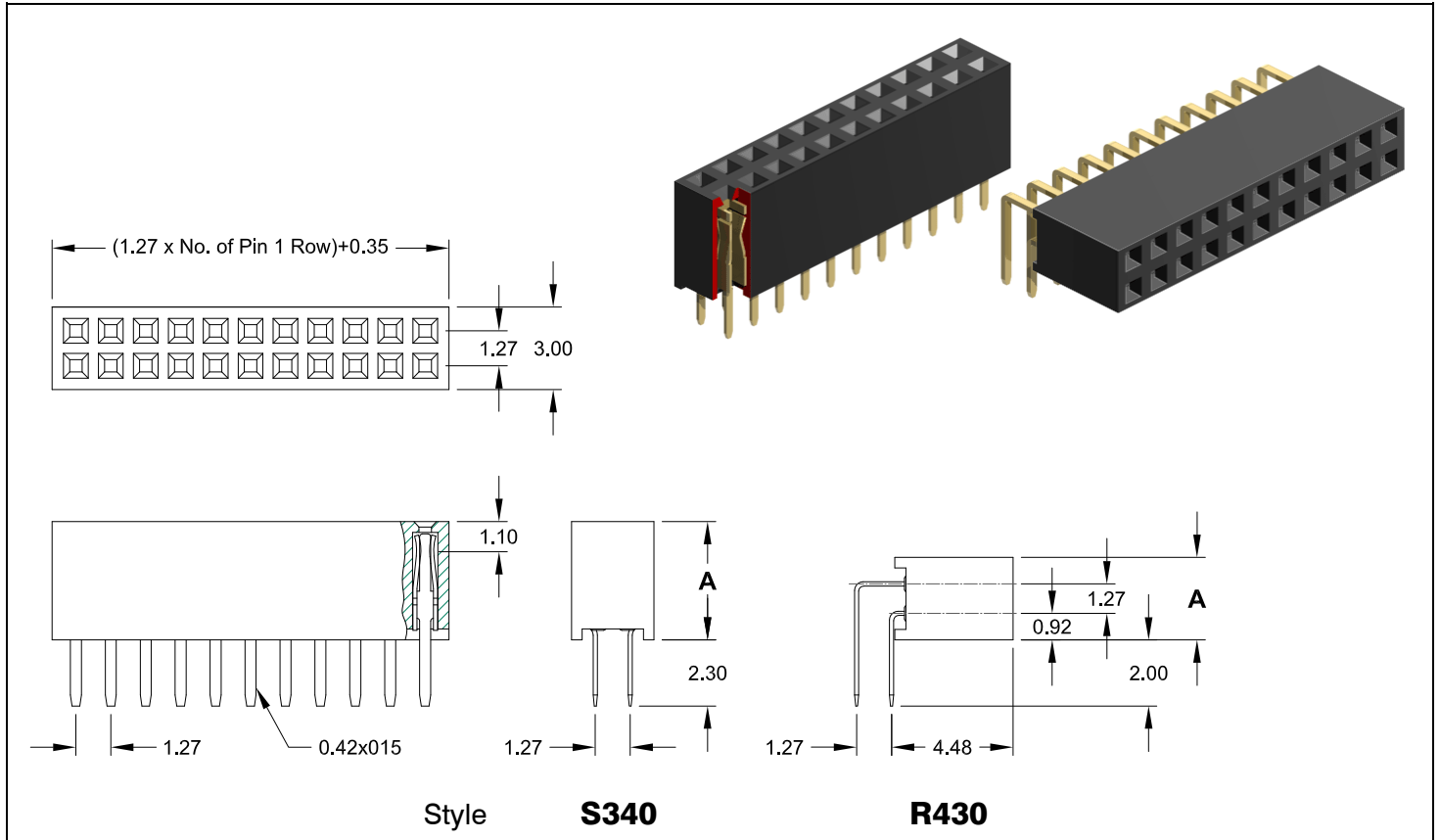

- Application and Features**
- 3.40 or 4.40mm height above board straight type
 - Hi-rel dual beam contact assures reliable PC-Board connections
 - Accepts 0.40mm square pins
 - Stand-off's facilitate post solder cleaning
 - Side stackable

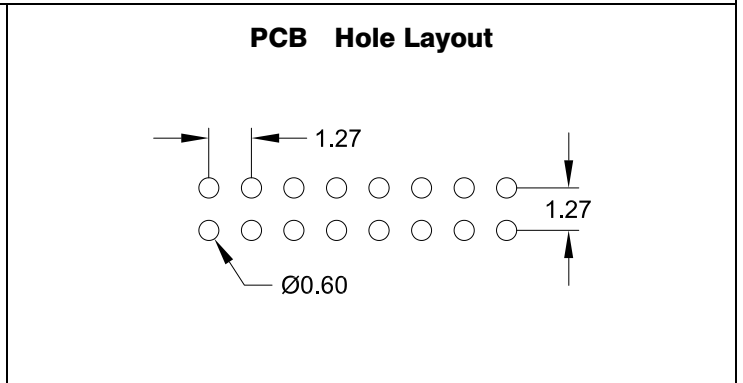

Specifications

Current rating	1 A	Operating temperature	- 40°C to +105°C
Insulation resistance	1000 MΩ min.	Contact material	(RoHS compliant) Phosphor Bronze
Contact resistance	20 mΩ max.	Insulator material	(RoHS compliant) LCP UL 94 V-0
Withstanding voltage	500 V AC		

How to order

BL2 - xxx - X xxx - 55/11

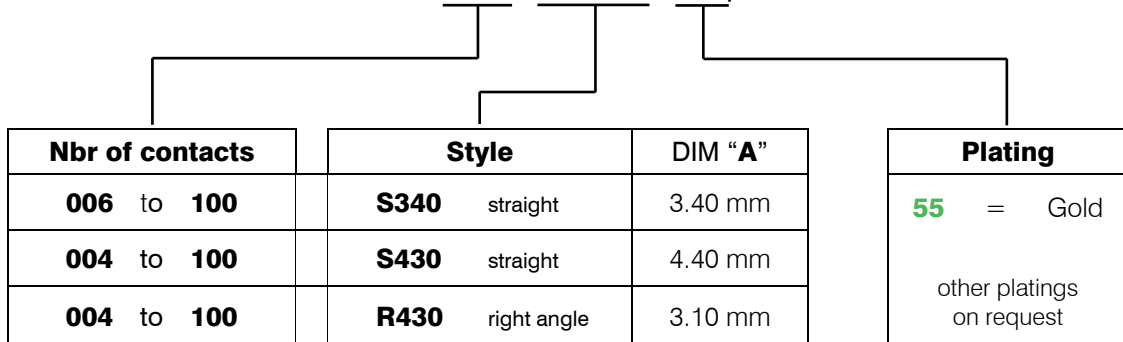

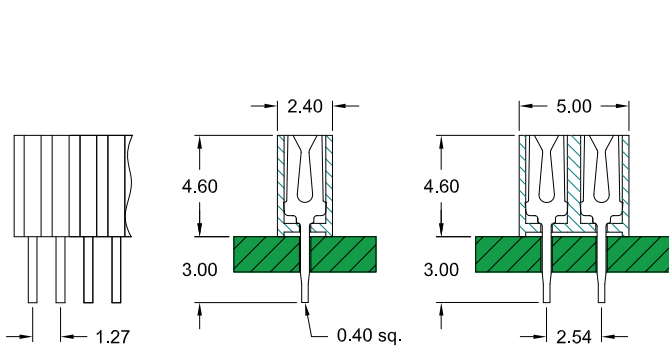
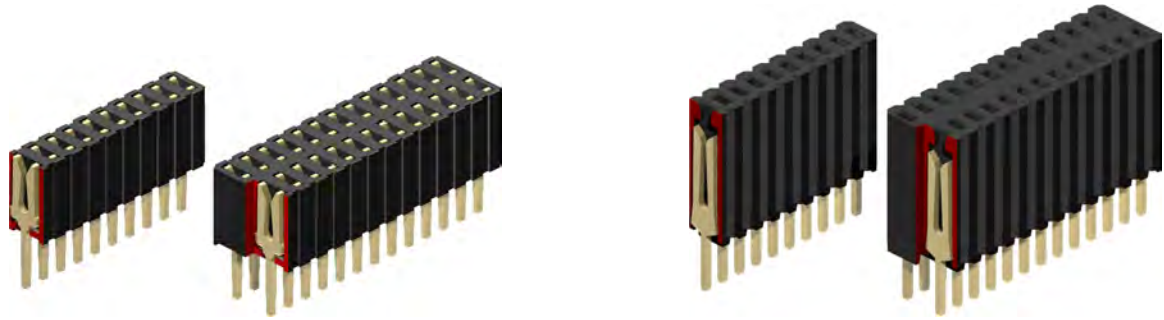

Style **S460**

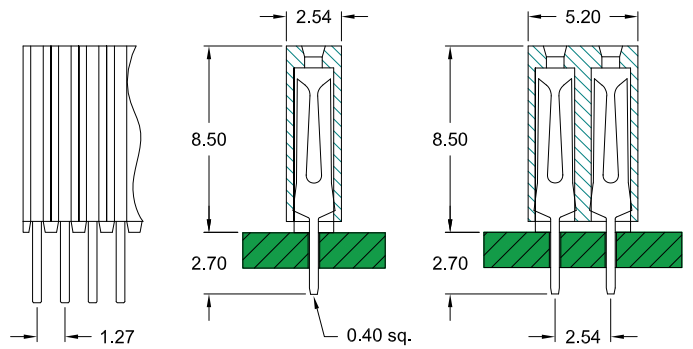

Style **S850**

Specifications

Current rating	1 A
Insulation resistance	1000 MΩ min.
Contact resistance	20 mΩ max.
Withstanding voltage	500 V AC
Operating temperature	- 40°C to +105°C
Contact material	Phosphor Bronze
Insulator material	PA9T UL 94 V-0

PCB Hole Layout

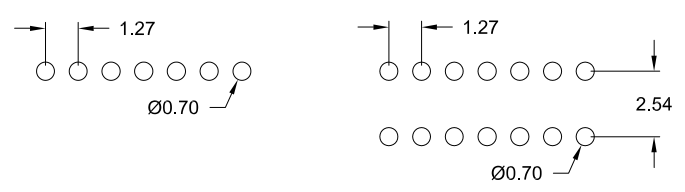

Application and Features

- Standard & low profile types
- Hi-rel fork contact design
- Mates with 0.46mm square or round Pin Header

How to order

BL x - xxx - S xxx - 55/1

Rows	Nbr of contacts	Style (height above PCB)	Plating
1 = single row	single row = 002 to 050	460 = 4.60 mm	55 = Gold
2 = dual row	dual row = 004 to 100	850 = 8.50 mm	other platings on request

1.27mm pitch Female Header
- THT- side entry

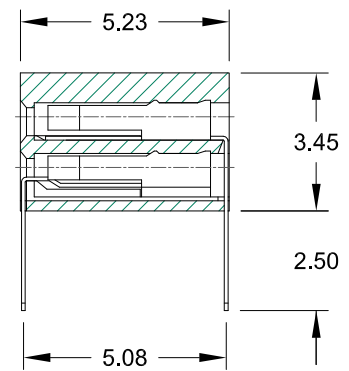
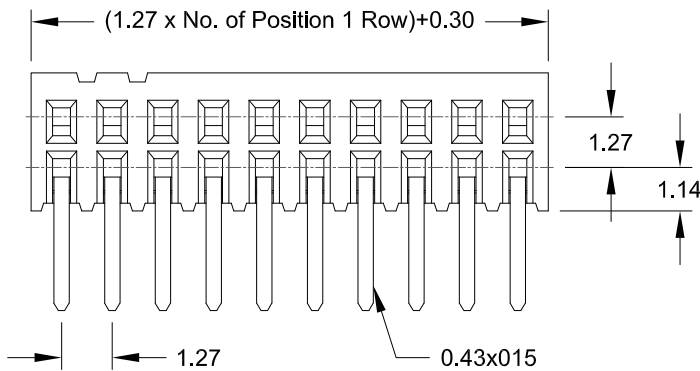
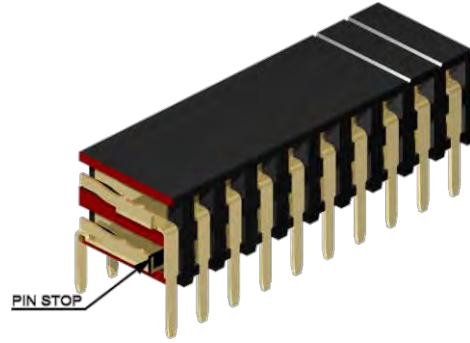
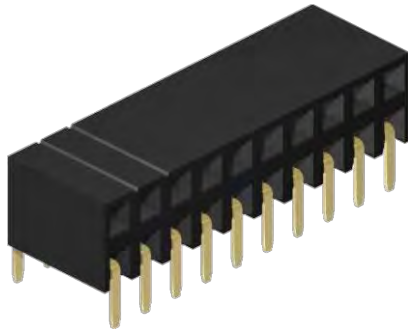

Application and Features

- **Standard: Tube packing**
- Hi-rel dual beam contact with "Pin Stop" assures reliable connections
- Accepts 0.40mm square pins; Pin Header 1.27mm x 1.27mm
- 3.45mm height above board
- Stand-off's facilitate post solder cleaning

PCB Hole Layout

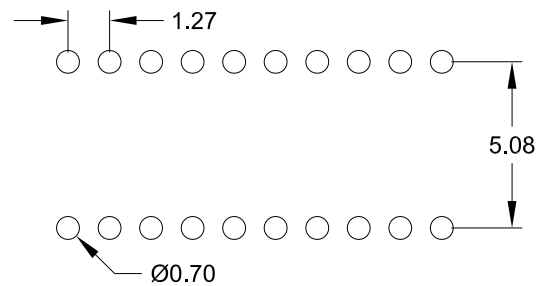

Specifications

Current rating	1 A
Insulation resistance	1000 MΩ min.
Contact resistance	20 mΩ max.
Withstanding voltage	500 V AC

Operating temperature	- 40°C to +105°C
Contact material	(RoHS compliant) Phosphor Bronze
Insulator material	(RoHS compliant) PA6T UL 94 V-0

How to order

BH2 - xxx - R345 - 55/11

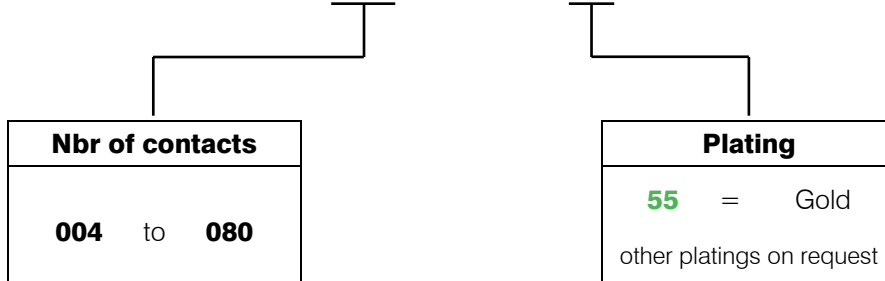

1.27mm x 2.54mm pitch Female Header

- SMT - dual row 6.00mm profile

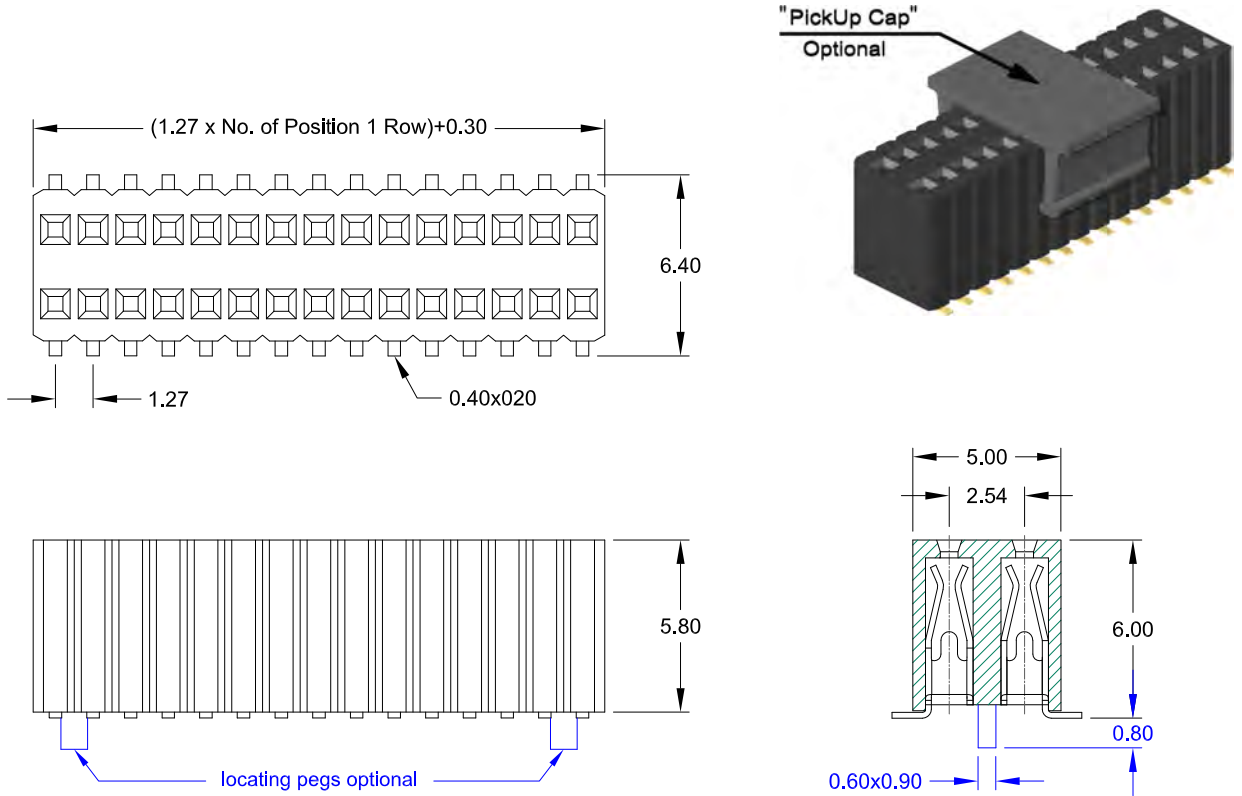

Specifications

Current rating	1 A
Insulation resistance	1000 MΩ min.
Contact resistance	20 mΩ max.
Withstanding voltage	500 V AC
Operating temperature	- 40°C to +105°C
Processing temperature	+250°C +0/-5°C for 5sec.
Contact material	(RoHS compliant) Phosphor Bronze
Insulator material	(RoHS compliant) PA6T UL 94 V-0

PCB Surface Mount & Hole Layout

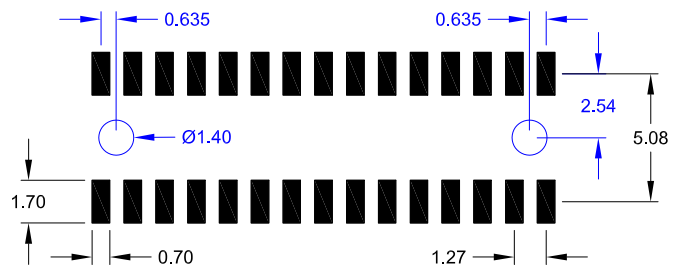

Application and Features

Standard: Tube packing, without "locating pegs" and without "PickUp Cap"

Hi-rel inner contact design, mates with 0.46 mm square Pin Headers

How to order

BS2 - xxx - H600 - 55/1 X

Nbr of contacts
006 to 100

Plating
55 = Gold

Options
without "locating pegs"
A = Tube packing; with „PickUp Cap“
B = Reel packing; with „PickUp Cap“
with "locating pegs"
C = Tube packing; without „PickUp Cap“
D = Tube packing; with „PickUp Cap“
E = Reel packing; with „PickUp Cap“

1.27mm pitch Female Header
 - SMT - single row 4.50mm profile

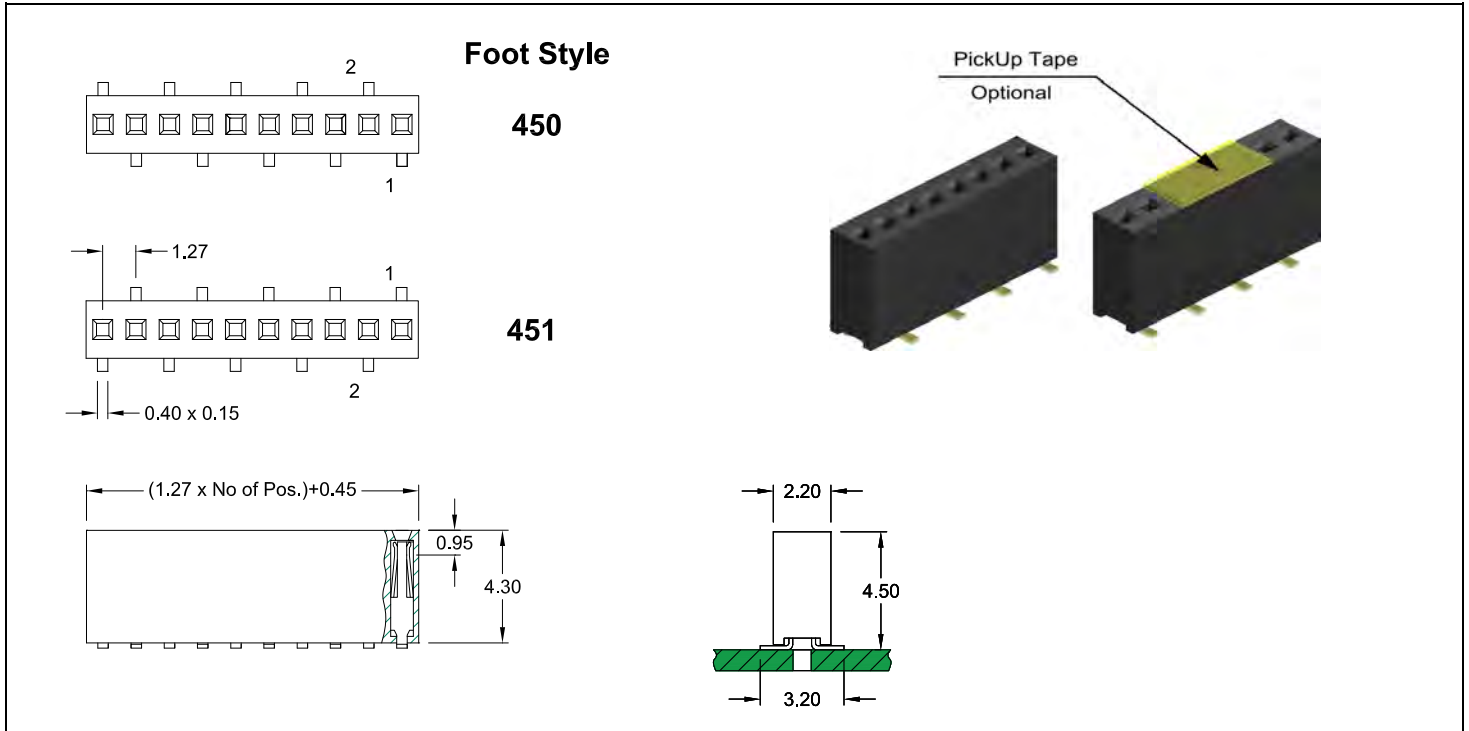

- ### Application and Features
- **Standard:**
Tube packing, without "PickUp Tape"
 - Also available with "PickUp Tape" (Mylar) for automatic suck assembly to the PCB
 - Low profile, 4.50mm height Type. Hi-rel dual beam contacts.
 - Mating with 1.27mm pitch, 0.40mm square Pin Headers.
 - Through Board mating possible

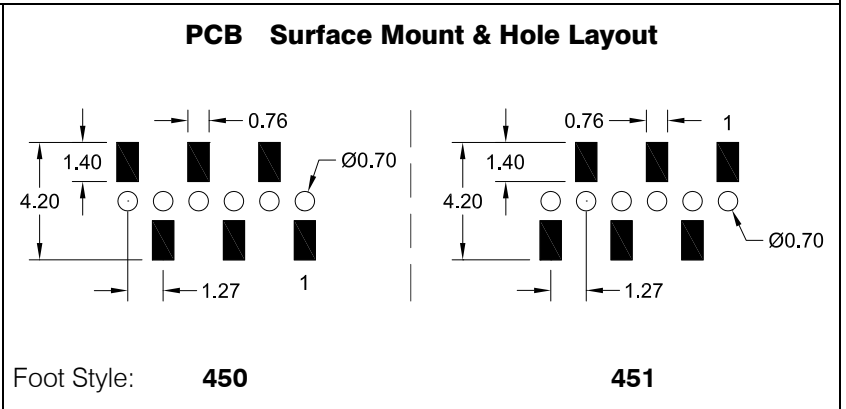

Specifications

Current rating	1 A	Operating temperature	- 40°C to +105°C
Insulation resistance	1000 MΩ min.	Processing temperature	+250°C +0/-5°C for 5sec.
Contact resistance	20 mΩ max.	Contact material (RoHS compliant)	Phosphor Bronze
Withstanding voltage	500 V AC	Insulator material (RoHS compliant)	PA9T UL 94 V-0

How to order

BS1 - xxx - H xxx - 55/11 XX

Nbr of contacts	Foot Style	Plating	Packing and "PickUp Tape" Option
003 to 050	450 Pls. choose 450 Style if odd pin count. 451 <i>Foot style see above detail</i>	55 = Gold	AT = Tube packing; with "PickUp Tape" BT = Reel packing; with "PickUp Tape"

1.27mm pitch Female Header
 - SMT - dual row 4.50mm profile

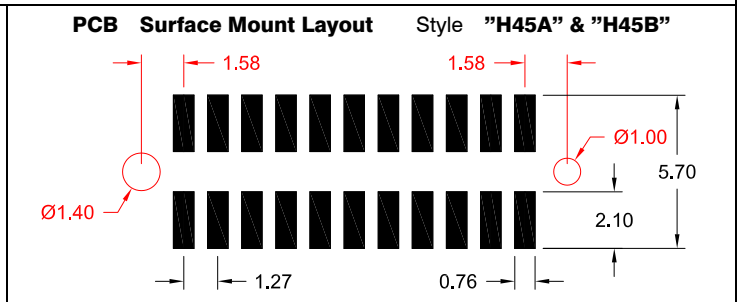
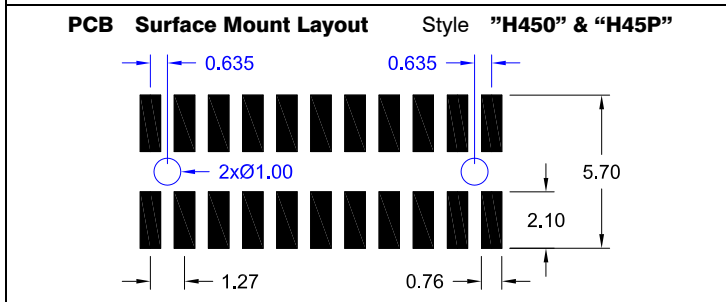
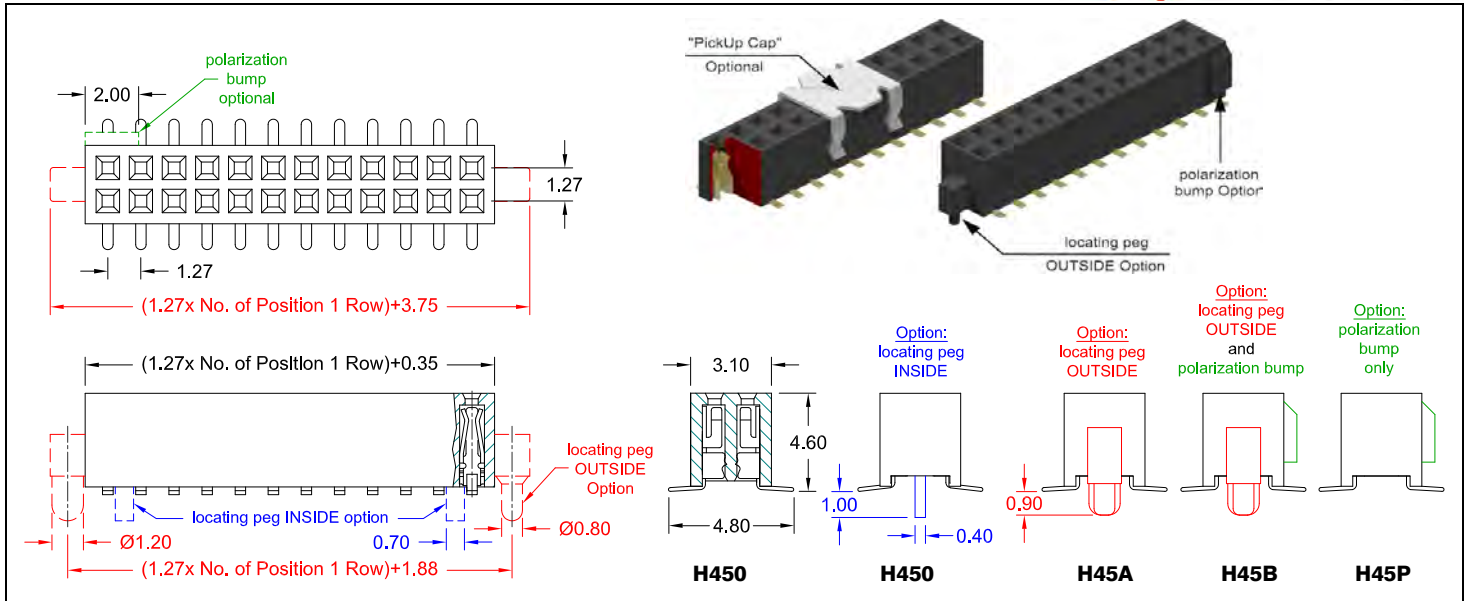

Specifications			
Current rating	1 A	Operating temperature	- 40°C to +105°C
Insulation resistance	1000 MΩ min.	Processing temperature	+250°C +0/-5°C for 5sec.
Contact resistance	20 mΩ max.	Contact material	PhBz (Gold flash plated)
Withstanding voltage	300 V AC	Insulator material	LCP UL 94 V-0

Application and Features

Standard: Tube packing without "locating pegs", without "PickUp Cap" and without polarization bump
 Also available with "PickUp Cap" for automatic suck assembly to the PCB
 Medium profile, 4.50mm height Type with Hi-rel dual beam contacts
 Mating with 1.27mm pitch Box Header SLS-xxx-H610- & -HP2x-55/11 (page 26), or 1.27mm pitch 0.40mm square or round Pin Headers

How to order

BS2 - xxx - H xxx - 55/11 X

Nbr of contacts	Style	Options
008 to 100	450 = without & with inside locating pegs 45A = with outside locating pegs 45B = with outside locating pegs & polarization bump 45P = with polarization bump; without locating pegs	See below
004 to 100 only		
BS2-xxx-H450-55/11 BS2-xxx-H450-55/11A BS2-xxx-H450-55/11B		

Order Code Options:

without "locating pegs"	with "locating pegs"
BS2-xxx-H450-55/11 = Tube packing; w/o „PickUp Cap“	BS2-xxx-H450-55/11C = Tube packing; w/o „PickUp Cap“
BS2-xxx-H45P-55/11 = Tube packing; w/o „PickUp Cap“	BS2-xxx-H450-55/11D = Tube packing; with „PickUp Cap“
BS2-xxx-H450-55/11A = Tube packing; with „PickUp Cap“	BS2-xxx-H45A-55/11D = Tube packing; with „PickUp Cap“
BS2-xxx-H45P-55/11A = Tube packing; with „PickUp Cap“	BS2-xxx-H45B-55/11D = Tube packing; with „PickUp Cap“
BS2-xxx-H450-55/11B = Reel packing; with „PickUp Cap“	BS2-xxx-H450-55/11E = Reel packing; with „PickUp Cap“
BS2-xxx-H45P-55/11B = Reel packing; with „PickUp Cap“	BS2-xxx-H45A-55/11E = Reel packing; with „PickUp Cap“
	BS2-xxx-H45B-55/11E = Reel packing; with „PickUp Cap“

1.27mm pitch Female Header
 - SMT - dual row 3.60mm profile

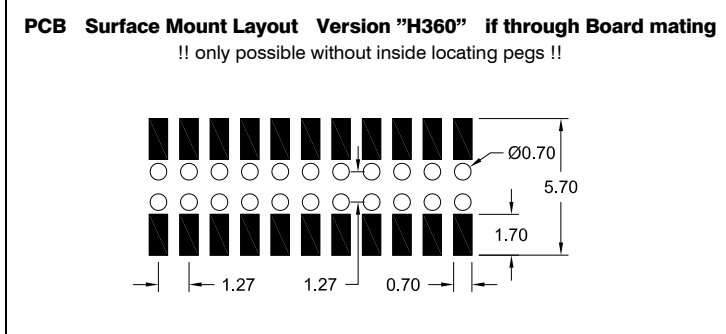
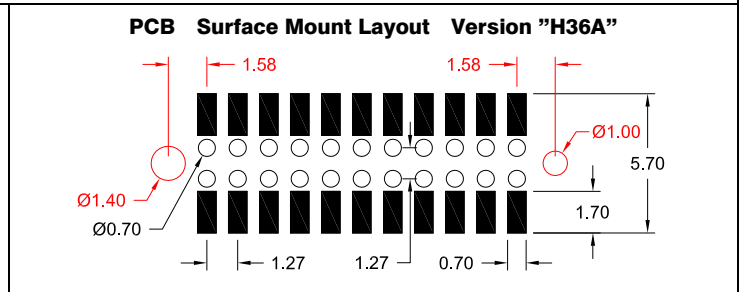
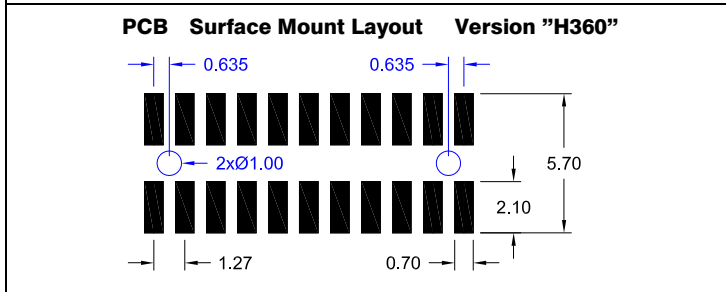
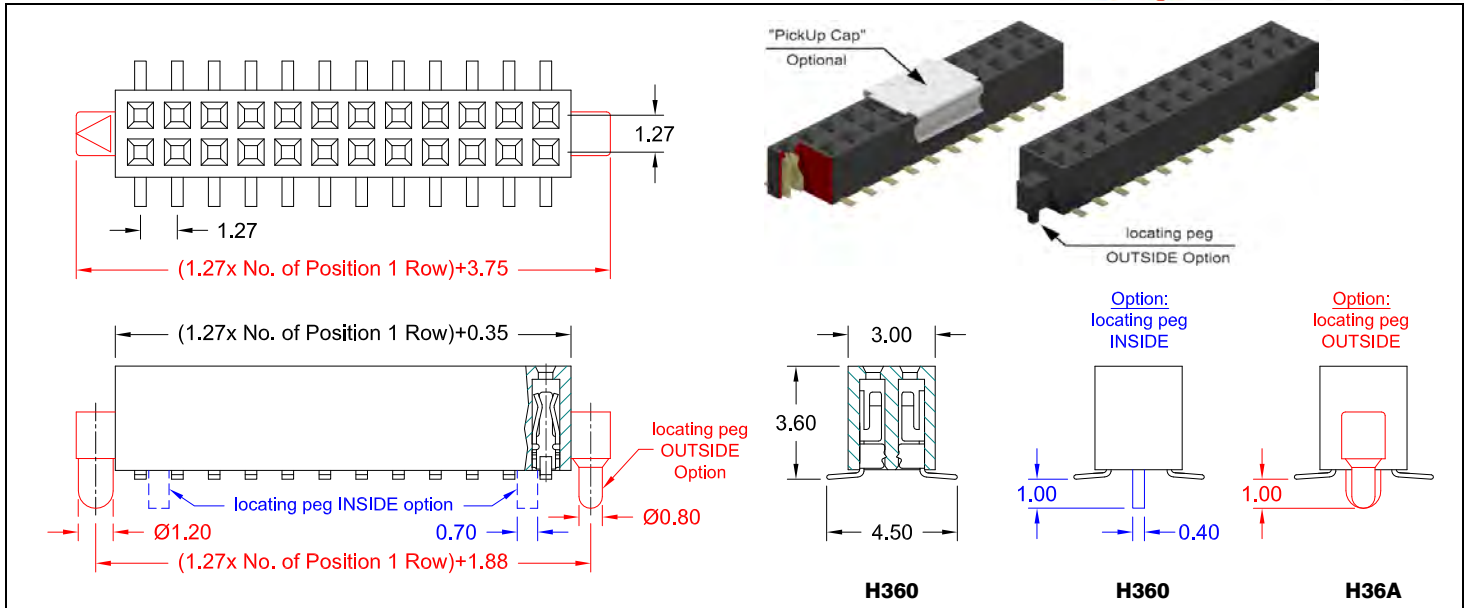

Application and Features

- **Standard: Tube packing, without locating pegs and without "PickUp Cap"**
- Also available with "PickUp Cap" for automatic suck assembly to the PCB
- Low profile, 3.60mm height Type. Hi-rel dual beam contacts.
- Mating with 1.27mm x 1.27mm pitch, 0.40mm square Pin Headers.
- Through Board mating possible

SPECIFICATIONS			
Current rating	1 A	Operating temperature	- 40°C to +105°C
Insulation resistance	1000 MΩ min.	Processing temperature	+250°C +0/-5°C for 5sec.
Contact resistance	20 mΩ max.	Contact material	PhBz (Gold flash plated)
Withstanding voltage	300 V AC	Insulator material	(RoHS compliant) LCP UL 94 V-0

How to order

BS2 - xxx - H xxx - 55/11 X

Nbr of contacts	Style	Options
006 to 100	360 = without & with inside locating pegs 36A = with outside locating pegs	See below

Order Code Options			
without "locating pegs"		with "locating pegs"	
BS2-xxx-H360-55/11	= Tube packing; w/o „PickUp Cap“	BS2-xxx-H360-55/11C	= Tube packing; w/o „PickUp Cap“
BS2-xxx-H360-55/11A	= Tube packing; with „PickUp Cap“	BS2-xxx-H360-55/11D	= Tube packing; with „PickUp Cap“
BS2-xxx-H360-55/11B	= Reel packing; with „PickUp Cap“	BS2-xxx-H36A-55/11D	= Tube packing; with „PickUp Cap“
		BS2-xxx-H360-55/11E	= Reel packing; with „PickUp Cap“
		BS2-xxx-H36A-55/11E	= Reel packing; with „PickUp Cap“

1.27mm pitch Female Header - SMT-
single row 2.10 & 2.20mm profile

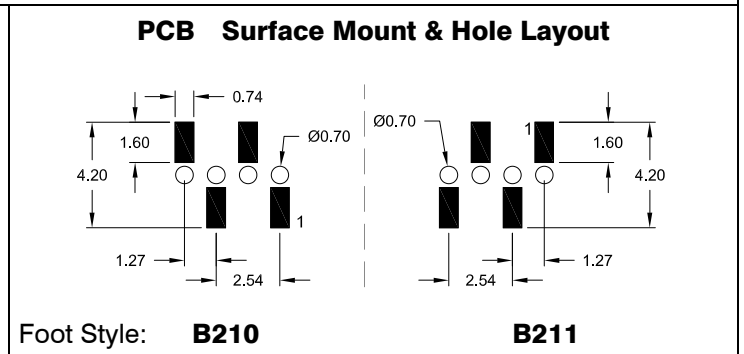
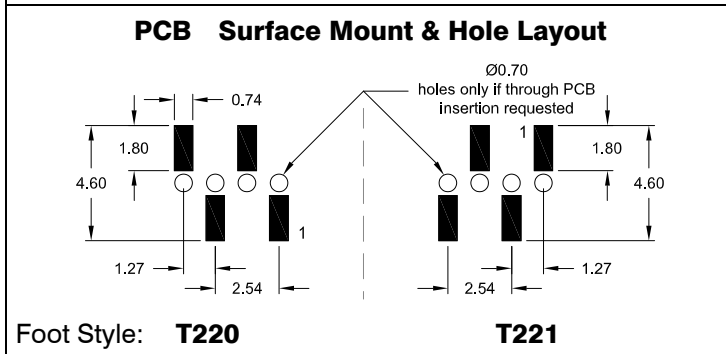
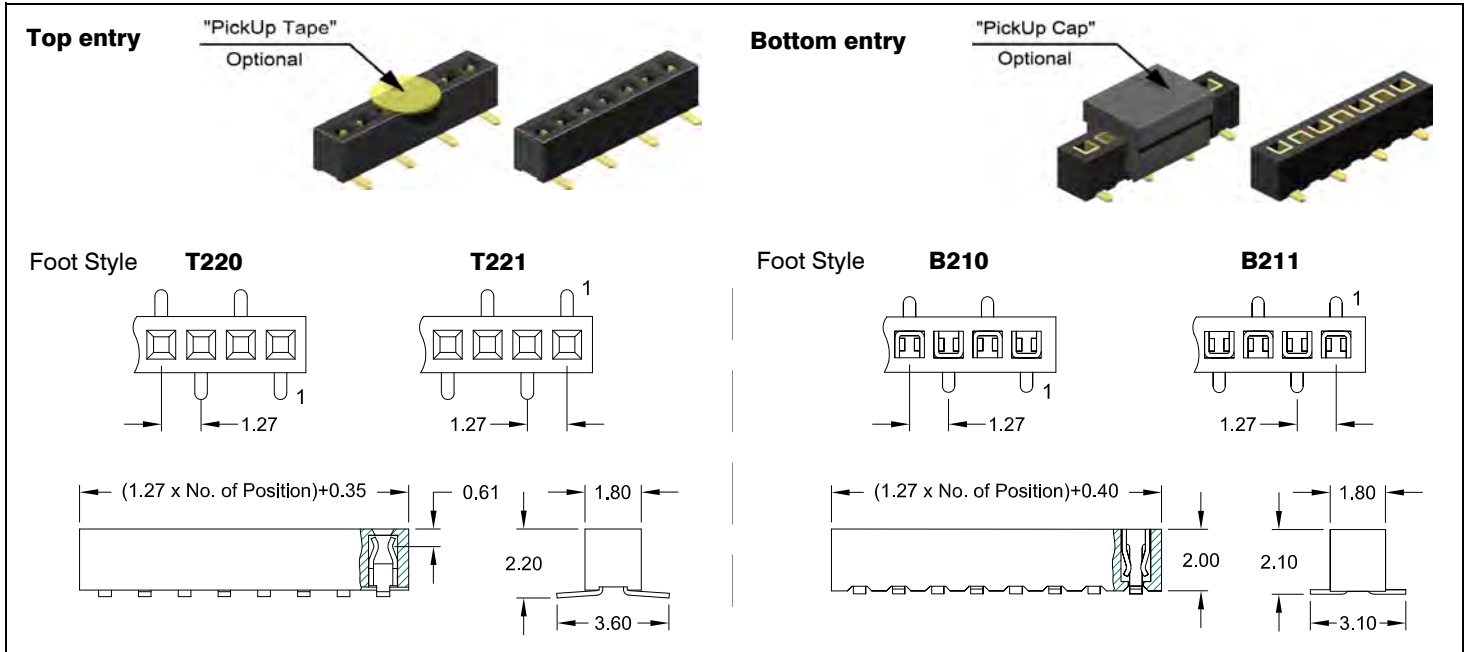

- Application and Features**
- **Standard: Tube packing, without "PickUp Cap" Option**
 - Also available "Reel" packing.
 - Low profile, 2.10 & 2.20mm height. Hi-rel dual beam contacts.
 - Mate with 1.27mm pitch 0.40mm square or round Pin Headers.
 - Designed for board to board small spacing interconnection.

Specifications

Current rating	1 A
Insulation resistance	1000 MΩ min
Contact resistance	20 mΩ max.
Withstanding voltage	500 V AC
Operating temperature	- 40°C to +105°C
Processing temperature	+250°C +0/-5°C for 5sec.
Contact material	(RoHS compliant) Phosphor Bronze
Insulator material	(RoHS compliant) TB21x = PA6T UL 94 V-0 TB22x = PA9T UL 94 V-0

How to order

BS1 - xxx - X xxx - 55/11 XX

Nbr of contacts	Foot Style	Plating	Packing and „PickUp Cap“ Option
Top Entry (T22x) 003 to 040	Top Entry T220 ; T221	55 = Gold	if B210 & B211 Type A = Tube packing; with „PickUp Cap“ B = Reel packing; with „PickUp Cap“ if T220 & T221 Type AT = Tube packing; with „PickUp Tape“ BT = Reel packing; with „PickUp Tape“
Bottom Entry(B21x) 003 to 050	Bottom Entry B210 ; B211 Pls. choose T220 or B210 style if odd pin count. Foot Style see above detail		

When using this female connector as a bottom entry connector, we recommend that the Pin Header pins protrude by around 2.00mm above the surface of the female connector after assembly. This will avoid any risk of separation of the Pin Header from the Female Header during shock and vibration.

1.27mm pitch Female Header - SMT-
Top & Bottom Entry 2.20mm profile

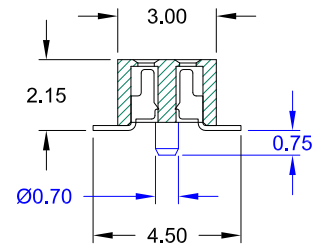
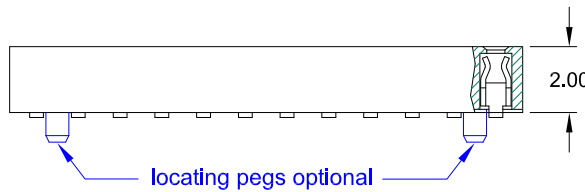
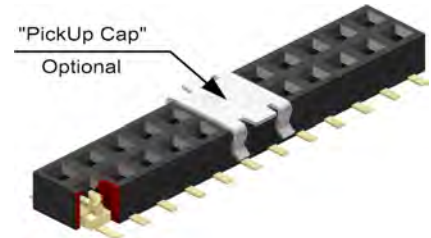
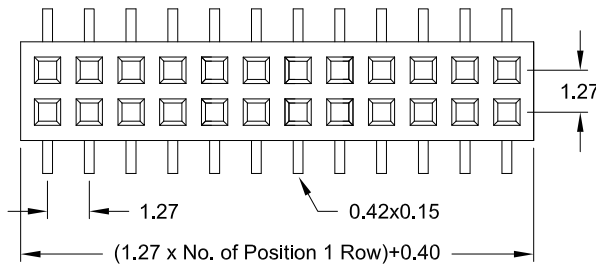

Application and Features

- **Standard: Tube packing, without locating pegs and without "PickUp Cap"**
- Also available "Reel" packing.
- Low profile, 2.20mm height. Hi-rel dual beam contacts.
- Mating with 1.27mm x 1.27mm pitch 0.40mm square or round Pin Headers.
- Designed for board to board small spacing interconnection.

PCB Surface Mount & Hole Layout

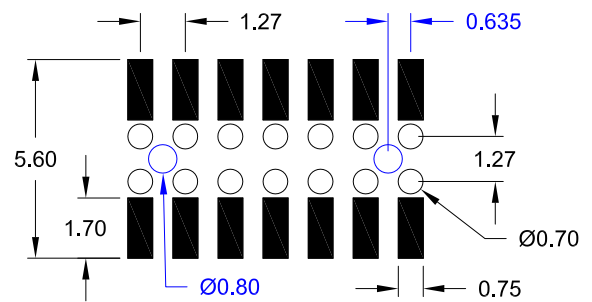

Specifications

Current rating	1 A
Insulation resistance	1000 MΩ min.
Contact resistance	20 mΩ max.
Withstanding voltage	500 V AC

Operating temperature	- 40°C to +105°C
Processing temperature	+250°C +0/-5°C for 5sec.
Contact material	Phosphor Bronze (RoHS compliant)
Insulator material	LCP UL 94 V-0 (RoHS compliant)

How to order

BS2 - xxx - TB22 - 55/11 X

Nbr of contacts
006 to 080

Plating
55 = Gold

Options	
without "locating pegs"	
A	= Tube packing; with „PickUp Cap“
B	= Reel packing; with „PickUp Cap“
with "locating pegs"	
C	= Tube packing; without „PickUp Cap“
D	= Tube packing; with „PickUp Cap“
E	= Reel packing; with „PickUp Cap“

When using this female connector as a bottom entry connector, we recommend that the Pin Header pins protrude by around 2.00mm above the surface of the female connector after assembly. This will avoid any risk of separation of the Pin Header from the Female Header during shock and vibration.

1.27mm pitch Female Header

- SMT- side entry

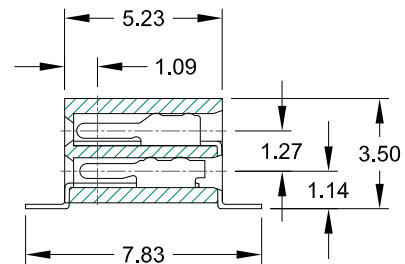
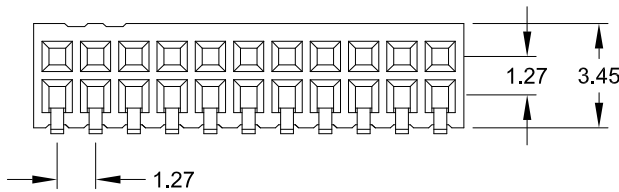
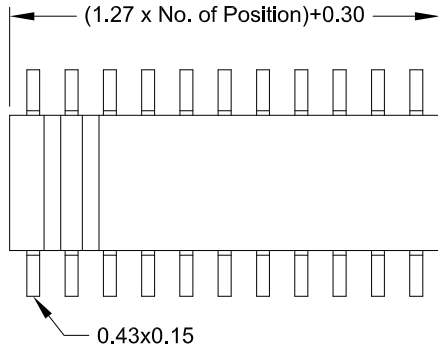
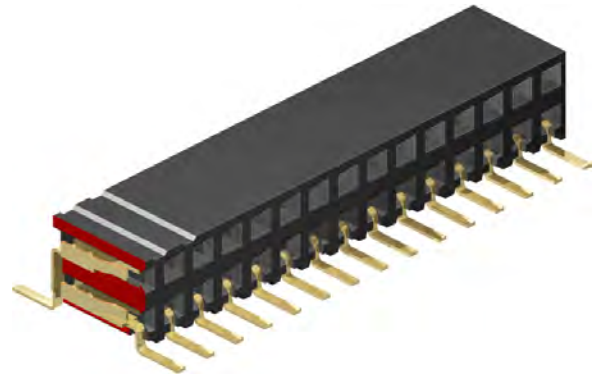

Application and Features

- **Standard: Tube packing**
- Hi-rel dual beam contact assures reliable PC-Board connections
- Accepts 0.40mm square pins; Pin Header 1.27mm x 1.27 mm
- 3.50mm height above board
- Automatic assembly to PCB possible

PCB Surface Mount Layout

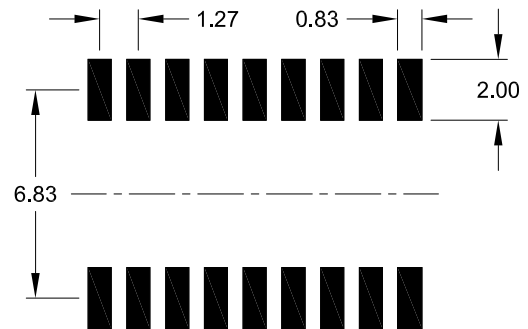

Specifications

Current rating	1 A	Operating temperature	- 40°C to +105°C
Insulation resistance	1000 MΩ min.	Processing temperature	+250°C +0/-5°C for 5sec.
Contact resistance	20 mΩ max.	Contact material	(RoHS compliant) Phosphor Bronze
Withstanding voltage	500 V AC	Insulator material	(RoHS compliant) LCP UL 94 V-0

How to order

BS2 - xxx - R345 - 55/11 X

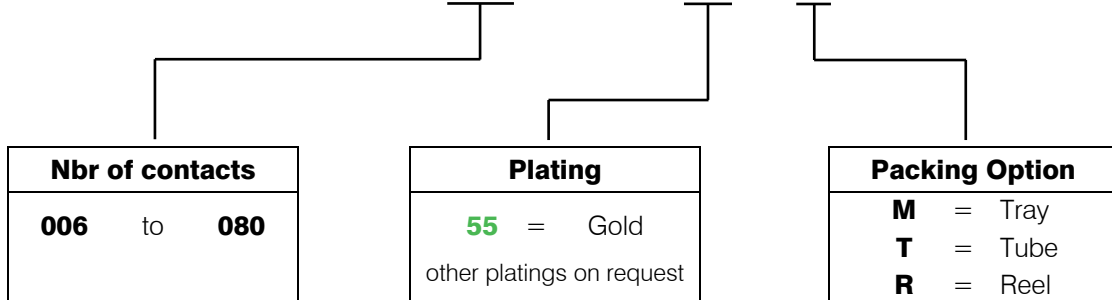

1.27mm pitch

IDC – Female Connector

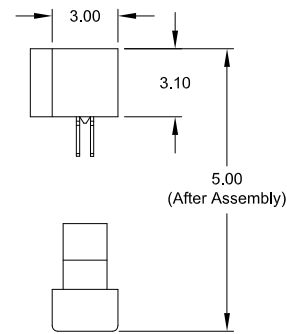
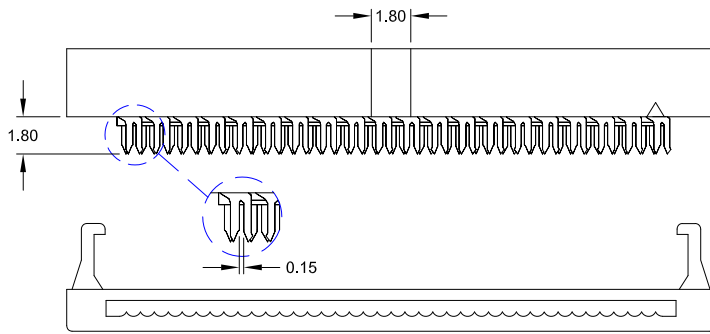
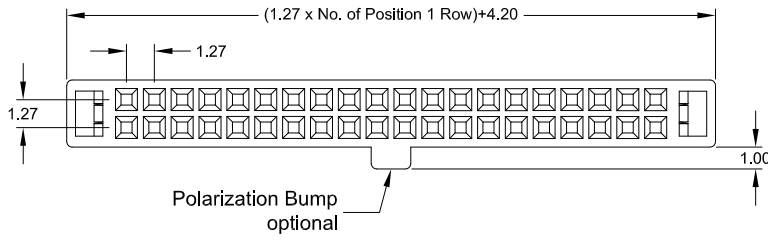

Specifications

Current rating	0.5 A	Operating temperature	- 40°C to +105°C
Contact resistance	30 mΩ max.	Contact material	(RoHS compliant) Phosphor Bronze
Insulation resistance	1000 MΩ min.	Insulator material	(RoHS compliant) PBT black UL 94 V-0
Withstanding voltage	250 V AC		

Application and Features

Designed to mate with 0.40mm square pins, Box (Shrouded) Header Type
 SLS – xxx – X 510 – 55/11
 High Quality dual beam contacts.
 Accepts 30 AWG 0.635mm pitch flat ribbon cable.

How to order

IDS - xxx - W050 - 55 /P

Nbr of contacts
006; 008; 010; 012
014; 016; 020; 022
024; 026; 030; 034
036; 040; 044; 050
060; 064; 068; 080

Plating
55 = Gold

Option
/P
if Polarization bump is requested

2.00mm pitch Pin Header
- THT - straight & right angle

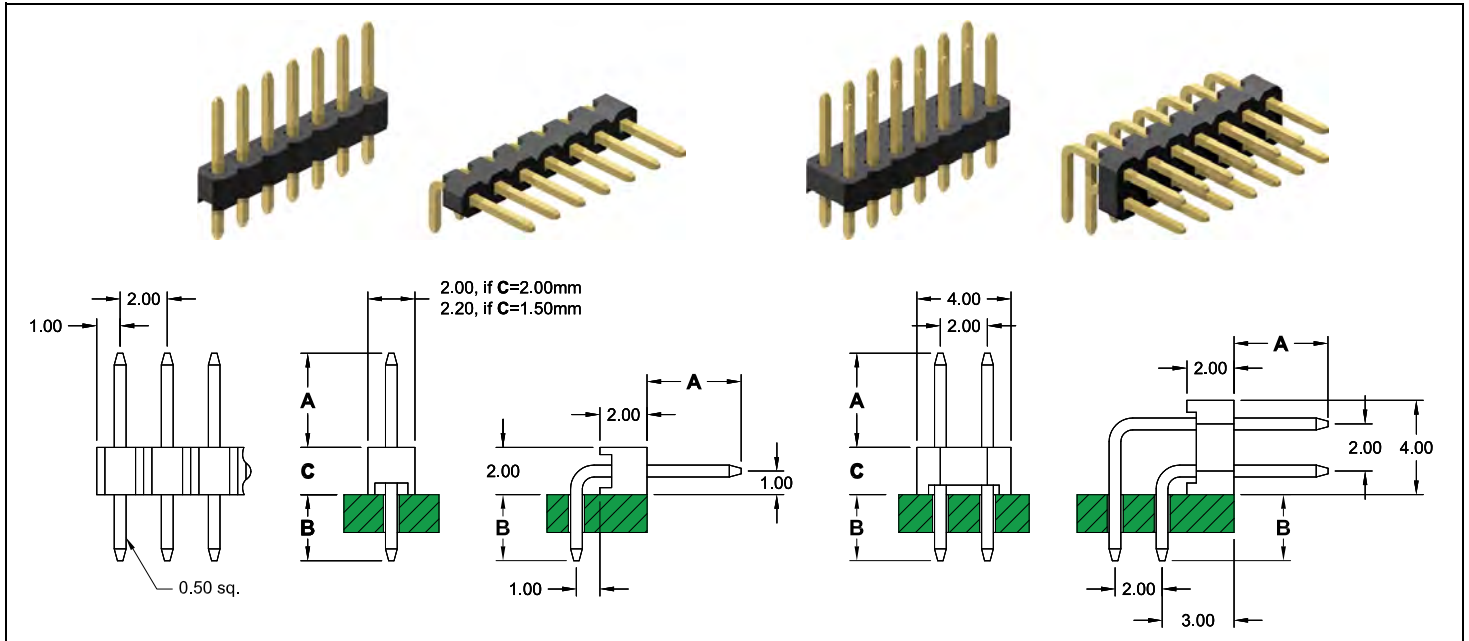

Specifications

Current rating	2 A
Insulation resistance	1000 MΩ min.
Withstanding voltage	500 V AC
Operating temperature	- 40°C to +105°C
Contact material	Copper alloy (RoHS compliant)
Insulator material	PBT or PA6T (RoHS compliant)
	UL 94 V-0
	Standard : PBT

PCB Hole Layout

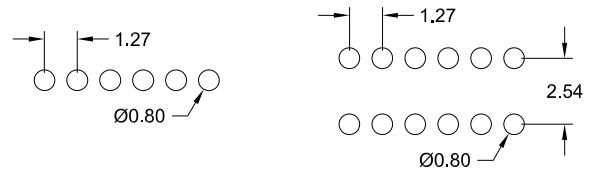

Application and Features

- Side and end stackable.
- Variable terminal lengths as well as two insulator thicknesses available for the straight type.
- Notches for easy breaking.
- Straight type with standoff's for post solder cleaning.

How to order

SL x - xxx - X xxx/xx - 55/2

Rows	Nbr of pins	Pin Style	DIM "C"	Material Code	Pin code	DIM "A"	DIM "B"	Plating
1 = single row	002 to 040	straight	2.00 mm	S = P.B.T. N = PA6T	088/01	4.00 mm	2.80 mm	55 = Gold (standard) 99 = Tin (leadfree tin) other platings on request
			1.50 mm	B = PA6T	096/00	4.00 mm	2.80 mm	
2 = dual row	004 to 080	right angle	2.00 mm	R = P.B.T. K = PA6T	088/02	6.00 mm	2.80 mm	
					088/03	6.80 mm	3.00 mm	
					088/04	4.00 mm	4.00 mm	
					088/05	3.70 mm	5.00 mm	
					096/01	6.00 mm	2.10 mm	
					096/02	4.50 mm	4.00 mm	
					096/03	1.70 mm	8.80 mm	
					096/04	4.00 mm	2.30 mm	
096/05	3.20 mm	3.50 mm						
096/06	4.00 mm	4.00 mm						
096/07	7.00 mm	2.20 mm						
096/08	3.60 mm	3.00 mm						
096/09	21.00 mm	2.54 mm						
096/10	5.10 mm	3.00 mm						
					106/00	3.20 mm	3.20 mm	other dimensions on request
					106/01	4.00 mm	2.80 mm	
					106/02	10.00 mm	2.80 mm	
					106/03	11.00 mm	2.80 mm	
					106/04	2.50 mm	2.80 mm	
					106/05	5.00 mm	2.80 mm	
					106/06	11.00 mm	2.40 mm	
					106/07	6.00 mm	2.80 mm	

2.00mm pitch Pin Header
 - THT - high plastic base

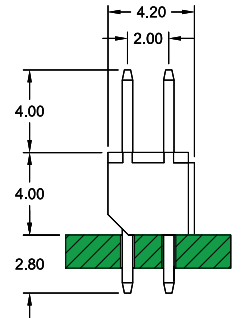
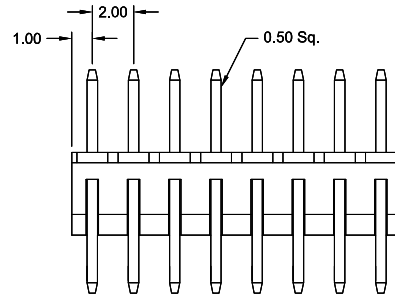
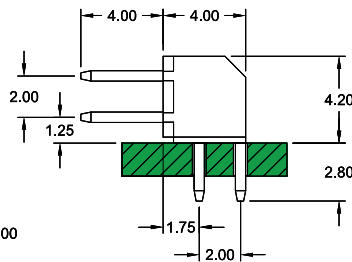
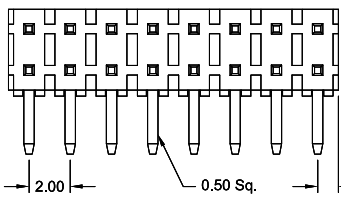
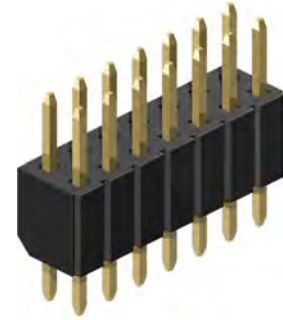
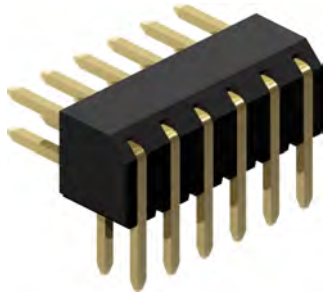

Style **R430**

Style **S400**

Specifications

Current rating	2 A
Insulation resistance	1000 MΩ min.
Withstanding voltage	500 V AC
Operating temperature	- 40°C to +105°C
Contact material	(RoHS compliant) Copper alloy
Insulator material	(RoHS compliant) PA6T UL 94 V-0

PCB Hole Layout

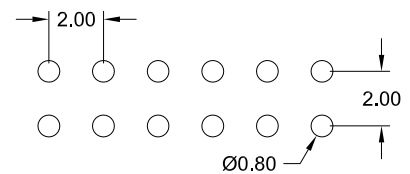

Application and Features

High Base Insulator standoff's facilitate post solder cleaning

Side stackable

Mate with 2.00mm pitch Female and Shunt Connector

How to order

SE2 - xxx - X xxx - xx/2

Nbr of pins

004 to **080**

Pin Style

S400 = straight
R430 = right angle

Plating

55 = Gold
95 = Tin/Gold
(tin leadfree)
 other platings on request

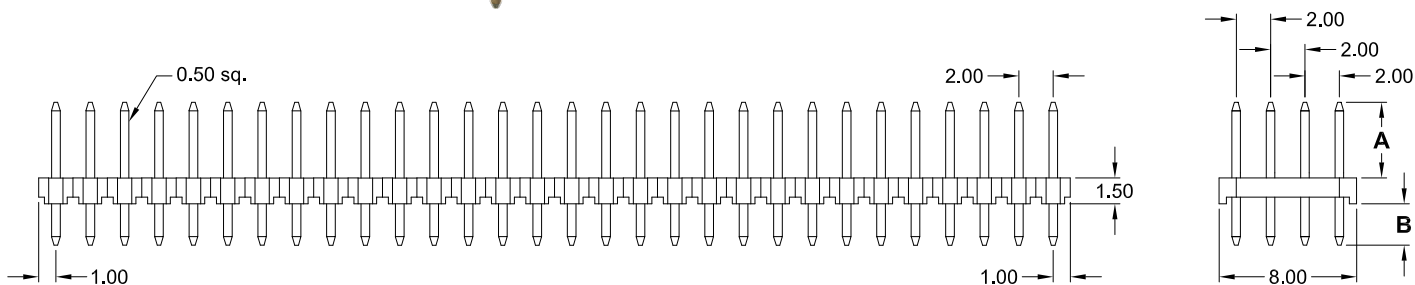
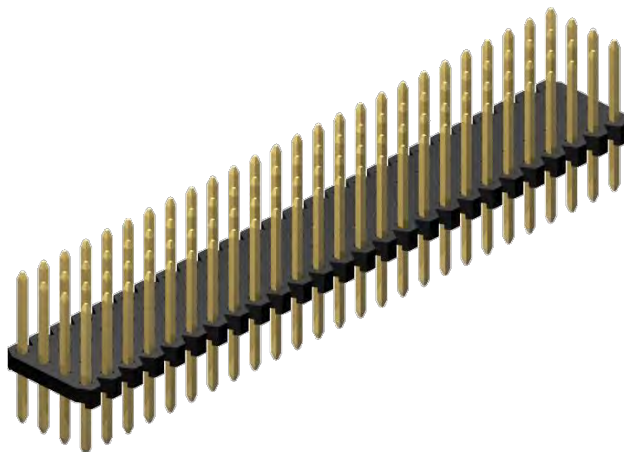

Specifications

Current rating	2 A
Insulation resistance	1000 MΩ min.
Withstanding voltage	500 V AC
Operating temperature	- 40°C to +105°C
Contact material	(RoHS compliant) Copper alloy
Insulator material	(RoHS compliant) PA6T UL 94 V-0

PCB Hole Layout

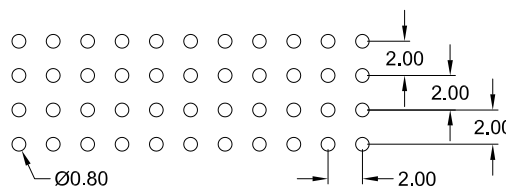

Application and Features

Designed for “board to board” small spacing interconnection
 Variable terminal length available
 With standoff’s for post solder cleaning
 Mate with Female Header BL4 – xxx – S630/x – xx/2

How to order

SL4 - xxx - S xxx/x - 55/2

Nbr of pins
008 to 160

Pin code	DIM “A”	DIM “B”
830/0	4.40 mm	2.40 mm
830/1	8.60 mm	3.60 mm
830/2	3.20 mm	3.50 mm
830/3	12.00 mm	2.40 mm
830/4	7.40 mm	2.70 mm
other dimensions on request		

Plating
55 = Gold
other platings on request

2.00mm pitch Board Spacer

- THT - single & dual row

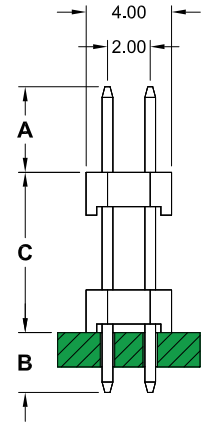
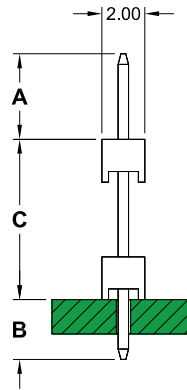
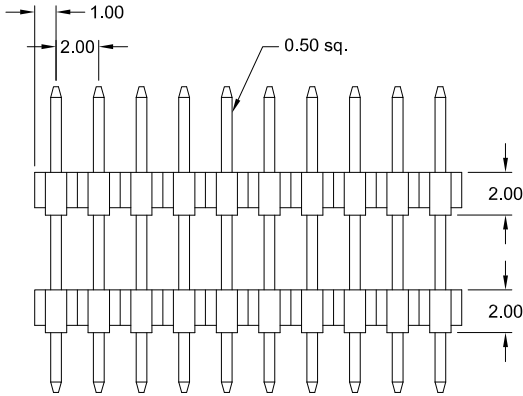
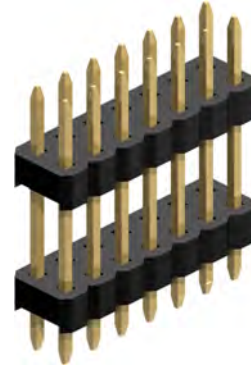

PCB Hole Layout

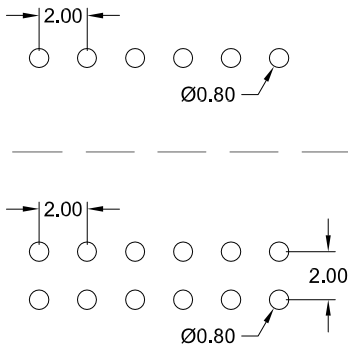

Specifications

Current rating	2 A
Insulation resistance	1000 MΩ min.
Withstanding voltage	500 V AC
Operating temperature	-40°C to +105°C
Contact material	Copper alloy <i>(RoHS compliant)</i>
Insulator material	PBT or PA6T, UL 94 V-0 <i>(RoHS compliant)</i> Standard : PBT

Pin code	DIM "A"	DIM "B"	DIM "C"
143/02	6.80 mm	2.80 mm	4.70 mm
104/01	2.70 mm	2.70 mm	5.00 mm
136/02	5.30 mm	3.20 mm	5.10 mm
191/01	9.30 mm	4.30 mm	5.50 mm
117/01	2.80 mm	2.80 mm	6.10 mm
143/01	4.00 mm	2.80 mm	7.50 mm
143/03	2.40 mm	3.90 mm	8.00 mm
150/01	4.00 mm	2.50 mm	8.50 mm
163/01	4.00 mm	2.80 mm	9.50 mm
180/03	5.00 mm	3.00 mm	10.00 mm
170/01	3.00 mm	3.00 mm	11.00 mm
180/02	3.00 mm	3.00 mm	12.00 mm
210/01	6.00 mm	3.00 mm	12.00 mm
260/04	9.00 mm	4.00 mm	13.00 mm
220/01	4.00 mm	2.80 mm	15.25 mm
252/02	5.20 mm	4.20 mm	15.80 mm
300/03	10.00 mm	3.00 mm	17.00 mm
225/01	2.50 mm	2.50 mm	17.50 mm
270/02	4.00 mm	3.00 mm	20.00 mm
410/01	9.00 mm	4.00 mm	28.00 mm
432/01	3.20 mm	3.20 mm	36.80 mm

other dimensions on request

How to order

SP x - xxx - X xxx/xx - 55/2

Rows	Nbr of pins	Insulator	Pin code	Plating
1 = single row	002 to 040	S = PBT N = PA6T	dimension and others see above table	55 = Gold
2 = dual row	004 to 080	PA6T processing temp.: +250°C +0/-5°C for 5sec.		other platings on request

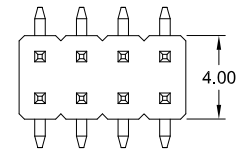
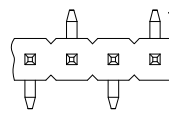
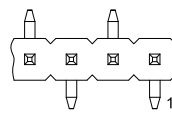
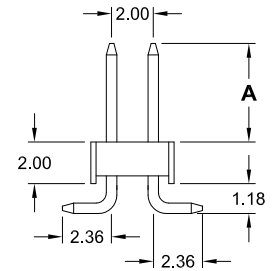
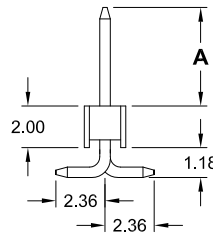
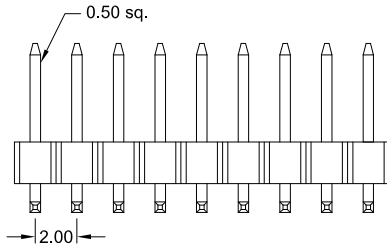
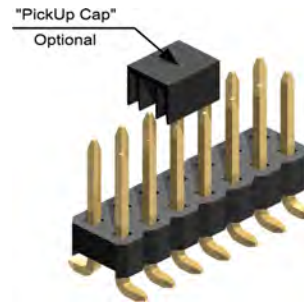

Foot Style: **085**

185

085

Application and Features

- **Standard: Tube packing and without "PickUp Cap"**
- Low Profile Insulator
- Assures reliable PC Board connections
- Mate with Female Header 2.00mm pitch

PCB Surface Mount Layout

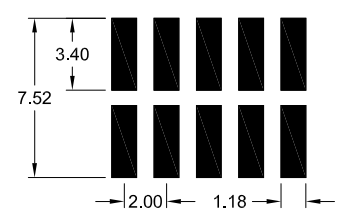
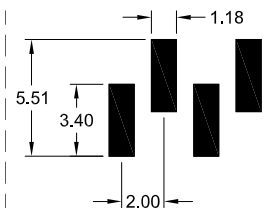
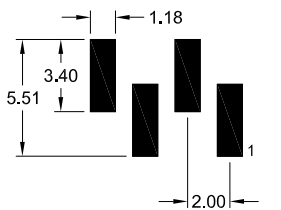

Foot Style: **085** (single row)

185 (single row)

085 (dual row)

Specifications

Current rating	2 A
Insulation resistance	1000 MΩ min.
Withstanding voltage	500 V AC

Operating temperature	- 40°C to +105°C
Processing temperature	+250°C +0/-5°C for 5sec.
Contact material	(RoHS compliant) Brass
Insulator material	(RoHS compliant) PA6T UL 94 V-0

How to order

SS x - xxx - H xxx / x - 55/2 X

Rows	Nbr of pins	Foot Style	Pin code	DIM "A"	Plating	Packing and „PickUp Cap“ Option
1 single row	002 to 040	085 185	0	4.73 mm	55 = Gold other platings on request	A = Tube packing; with „PickUp Cap“ B = Reel packing; with „PickUp Cap“
		Pls. choose 085 Style if odd pin count.		1		
2 dual row	004 to 080	085	2	13.57 mm		
			3	6.50 mm		
			4	8.07 mm		
			5	7.62 mm		
			6	9.10 mm		
			7	10.00 mm		
			other dimensions on request			

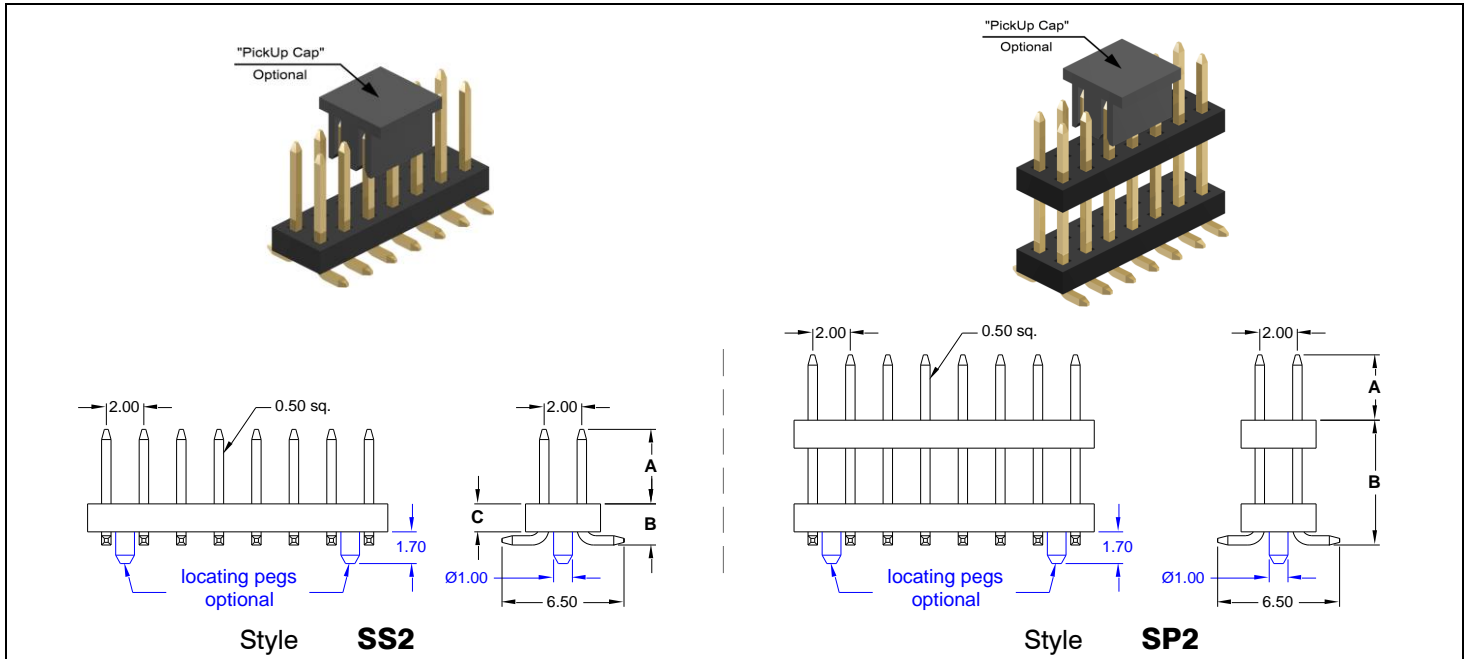

Application and Features

- **Standard: Tube packing, without "locating pegs" and without "PickUp Cap"**
- Designed for "board to board" spacing
- Variable terminal length available
- Mate with Female Header 2.00 x 2.00mm pitch

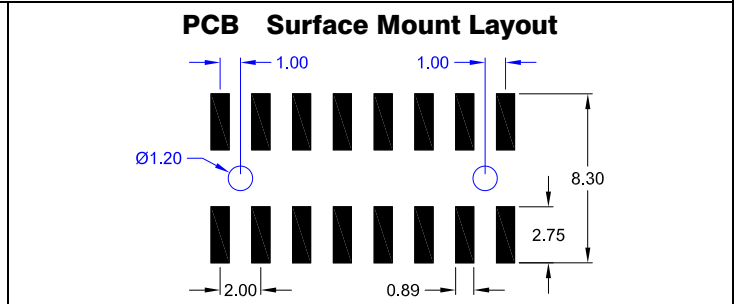

Specifications

Current rating	2 A	Operating temperature	- 40°C to +105°C
Insulation resistance	1000 MΩ min.	Processing temperature	+250°C +0/-5°C for 5sec.
Contact resistance	20 mΩ max.	Contact material	(RoHS compliant) Copper alloy
Withstanding voltage	500 V AC	Insulator material	(RoHS compliant) PA6T or PA9T UL 94 V-0

How to order

S X 2 - xxx - HX xxx/x - 55/2 X

Style	Nbr of pins	Material	Pin code	DIM "A"	DIM "B"	DIM "C"	Plating	Options
S Low Profile	006 to 050	H = PA6T	064/0	6.00 mm	2.20 mm	1.50 mm	55 = Gold	without "locating pegs" A = Tube packing; with "PickUp Cap" B = Reel packing; with "PickUp Cap"
			064/1	4.00 mm	2.20 mm	1.50 mm		
			064/2	3.50 mm	2.70 mm	2.00 mm		
			064/3	5.80 mm	2.20 mm	1.50 mm		
			064/4	3.20 mm	2.20 mm	1.50 mm		
			064/5	3.60 mm	2.20 mm	1.50 mm		
			064/6	4.00 mm	2.70 mm	2.00 mm		
			064/7	13.50 mm	2.65 mm	2.00 mm		
			064/8	9.50 mm	2.20 mm	1.50 mm		
			064/9	8.00 mm	2.20 mm	1.50 mm		
P Board Spacer	006 to 050	HN = PA9T	065/0	6.00 mm	6.00 mm		other platings on request	with "locating pegs" (if, DIM "C"=1.50mm only) C = Tube packing; without "PickUp Cap" D = Tube packing; with "PickUp Cap" E = Reel packing; with "PickUp Cap"
			065/A	5.40 mm	7.00 mm			
			065/4	3.90 mm	8.00 mm			
			065/7	7.50 mm	8.50 mm			
			065/1	6.00 mm	10.00 mm			
			065/2	6.00 mm	12.00 mm			
			065/6	9.50 mm	12.00 mm			
			065/9	5.00 mm	12.30 mm			
			065/8	4.65 mm	12.70 mm			
			065/3	4.00 mm	13.33 mm			
				other dimensions on request				

2.00mm pitch Pin Header - slanted -
- SMT - single and dual row

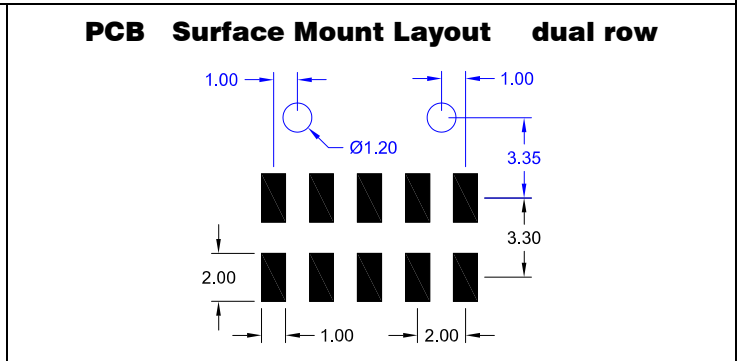
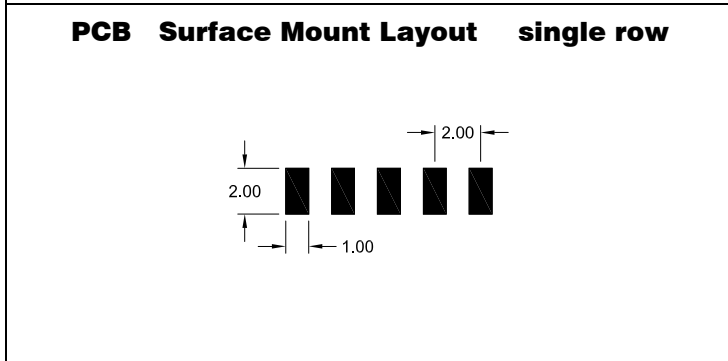
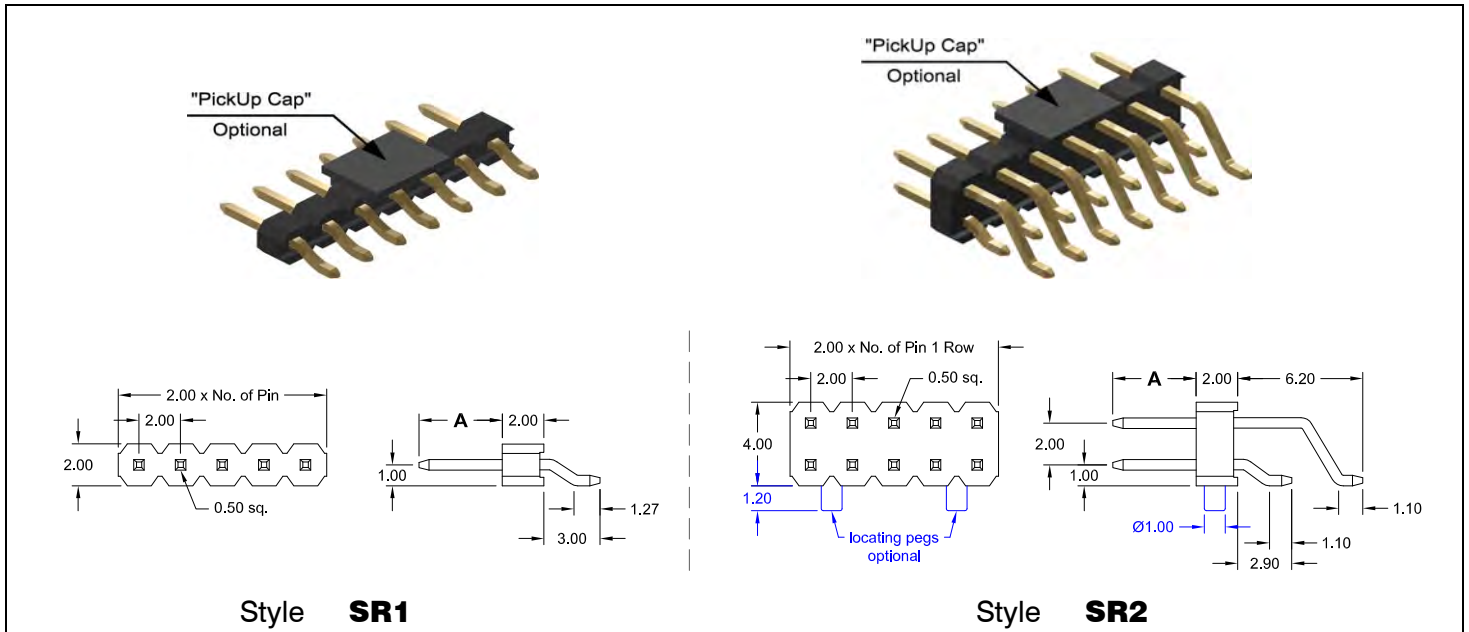

Specifications

Current rating	2 A
Insulation resistance	1000 MΩ min.
Withstanding voltage	500 V AC

Operating temperature	- 40°C to +105°C
Processing temperature	+250°C +0/-5°C for 5sec.
Contact material	(RoHS compliant) Copper alloy
Insulator material	(RoHS compliant) PA6T UL 94 V-0

How to order

SR x - xxx - H xxx/x - 55/2 X

Rows	Nbr of pins	Pin code	DIM "A"	Plating	Options	
1 = single row	002 to 040	093/ 0	4.00 mm	55 = Gold other platings on request	without "locating pegs" A = Tube packing; with „PickUp Cap“ B = Reel packing; with „PickUp Cap“	
		093/ 1	4.45 mm			
		093/ 2	3.20 mm			
		093/ 3	6.00 mm			
2 = dual row	006 to 080	122/ 0	4.00 mm			with "locating pegs" (Dual Row Type only) C = Tube packing; without "PickUp Cap" D = Tube packing; with "PickUp Cap" E = Reel packing; with "PickUp Cap"
		122/ 1	6.00 mm			
		122/ 2	4.45 mm			
		122/ 3	5.00 mm			
		122/ 4	3.20 mm			
		122/ 5	3.50 mm			
		122/ 6	8.00 mm			
122/ 7	4.80 mm					

2.00mm pitch

Box Header

- THT - right angle - straight - raised

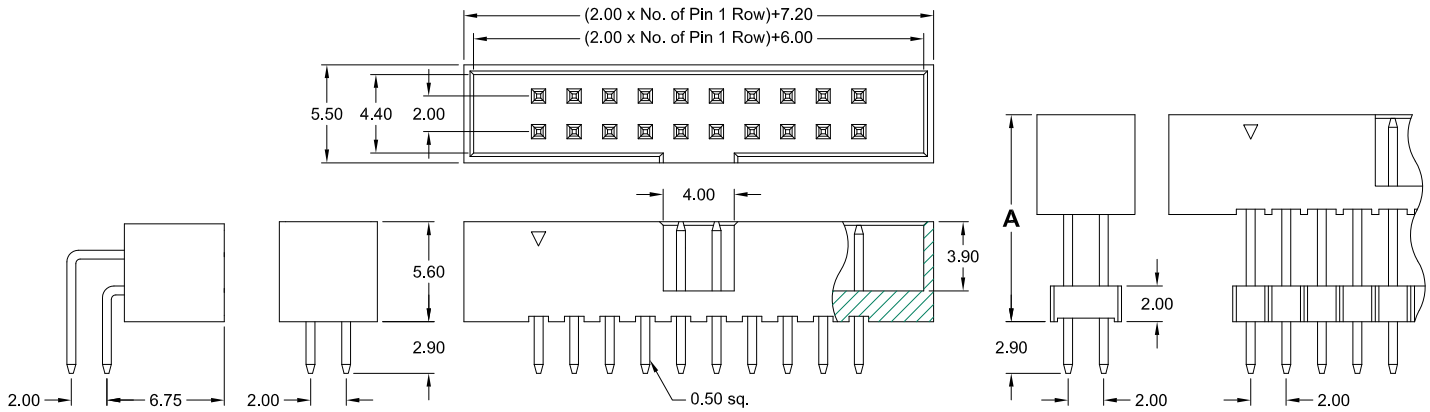
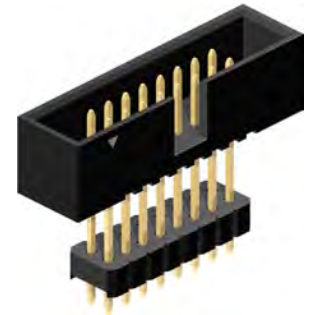
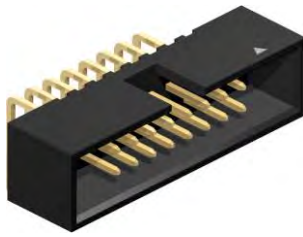

Style **R562**

S562

D762/xx

Application and Features

- Designed to mate with IDC female connector IDS-xxx-X200-95/P
- Reliable flat cable to PCB connection
- No ejection latches for space saving

PCB Hole Layout

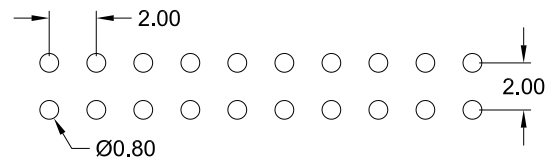

Specifications

Current rating	1 A	Operating temperature	- 40°C to +105°C
Insulation resistance	1000 MΩ min.	Contact material	(RoHS compliant) Copper alloy
Withstanding voltage	500 V AC	Insulator material	(RoHS compliant) PBT UL 94 V-0

How to order

SLS - xxx - Xxxx - 55/2

Nbr of pins
006 to 068
except: 038; 042; 046; 048; 052 054; 056; 058; 062; 066

Style
S562 = straight
R562 = right angle
Raised Style:
D762/00 DIM "A" = 7.60 mm
D762/01 DIM "A" = 17.80 mm
D762/02 DIM "A" = 10.40 mm
other dimensions on request

Plating
55 = Gold
other platings on request

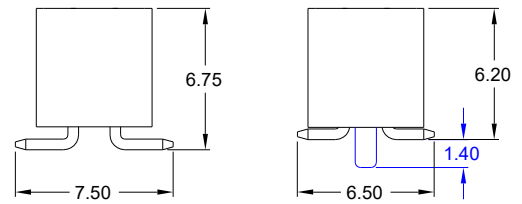
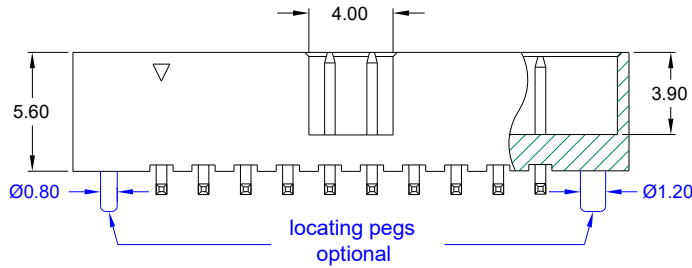
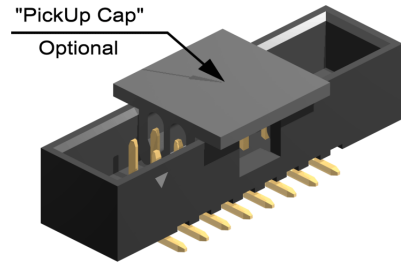
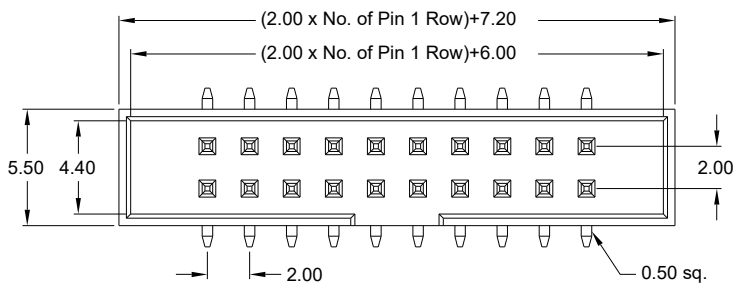

Application and Features

- **Standard:**
without locating pegs, Tray packing and without "PickUp Cap"
- Also available "Reel" packing
- Designed to mate with IDC female connector IDS-xxx-X 200-95/P
- Reliable flat cable to PCB connection
- No ejection latches for space saving

PCB Surface Mount Layout

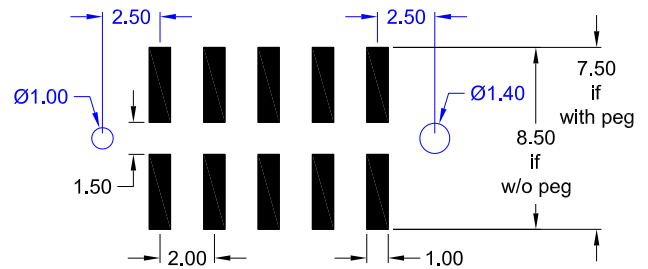

Specifications

Current rating	1 A
Insulation resistance	1000 MΩ min.
Withstanding voltage	500 V AC

Operating temperature	- 40°C to +105°C
Processing temperature	+250°C +0/-5°C for 5sec.
Contact material	(RoHS compliant) Copper Alloy
Insulator material	(RoHS compliant) PA6T UL 94 V-0

How to order

SLS - xxx - H562 - 55/2 X

Nbr of pins
without "locating pegs" 006 to 068
except: 038; 042; 046; 048; 052 054; 056; 058; 062; 066
with "locating pegs" 008 to 050

Plating
55 = Gold
other platings on request

Options
without "locating pegs"
F = Tray packing; with „PickUp Cap“
T = Tube packing; without „PickUp Cap“
A = Tube packing; with „PickUp Cap“
B = Reel packing; with „PickUp Cap“
with "locating pegs"
C = Tube packing; without „PickUp Cap“
D = Tube packing; with „PickUp Cap“
E = Reel packing; with „PickUp Cap“

2.00mm pitch Female Header
- THT - low profile

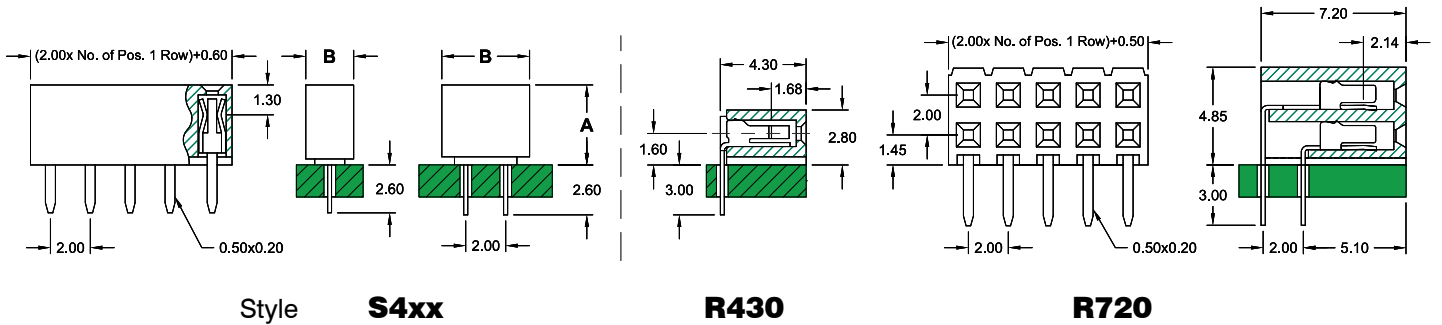
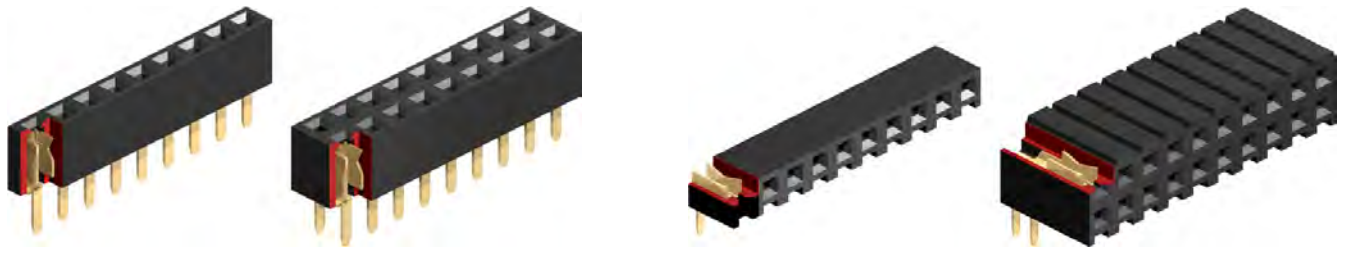

Style **S4xx**

R430

R720

Specifications

Current rating	2 A
Insulation resistance	1000 MΩ min.
Contact resistance	20 mΩ max.
Withstanding voltage	500 V AC
Operating temperature	- 40°C to +105°C
Contact material	Phosphor Bronze
Insulator material	PA6T UL 94 V-0

PCB Hole Layout

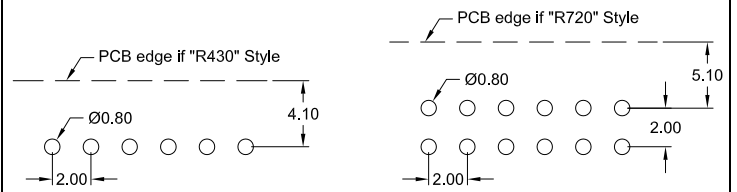

Application and Features

Low profile, 4.00mm and 4.30mm height single & dual row straight.
Designed for board to board small spacing interconnection.
High quality dual beam contacts mating with 0.50 x 0.50mm Pin Header.

How to order

BL x - xxx - Xxxx - 55/2

Rows	Nbr of contacts	Style	Plating
1 = single row	S400 & S430 = 002 to 040 R430 = 003 to 025	S400 = straight – single row : "A"=4.00 mm "B"=2.20 mm straight – dual row : "A"=4.00 mm "B"=4.20 mm S430 = straight – single row : "A"=4.30 mm "B"=2.40 mm straight – dual row : "A"=4.30 mm "B"=4.60 mm R430 = right angle – single row R720 = right angle – dual row	55 = Gold other platings on request
2 = dual row	S400 & S430 = 004 to 080 R720 = 004 to 080		

2.00mm pitch Female Header
 - THT - 6.35mm profile straight

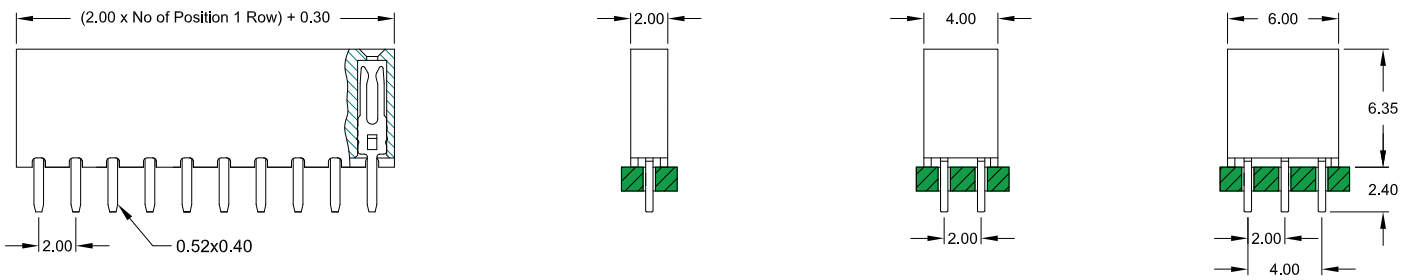
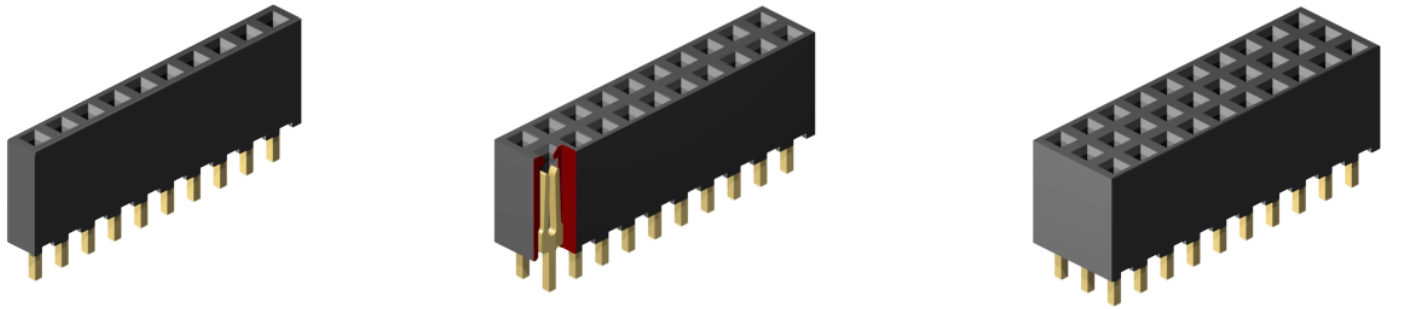

Application and Features

- For board-to-board connections
- Ideal solution for PC/104 Systems
- Accepts 0.50mm square pins
- Hi-rel fork contact design

PCB Hole Layout

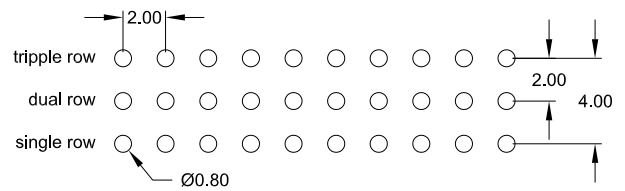

Specifications

Current rating	2 A	Operating temperature	- 40°C to +105°C
Insulation resistance	1000 MΩ min.	Contact material	(RoHS compliant) Copper Alloy
Contact resistance	20 mΩ max.	Insulator material	(RoHS compliant) LCP UL 94 V-0
Withstanding voltage	500 V AC		

How to order

BL x - xxx - SH635 - 55/2

Rows
1 = single row
2 = dual row
3 = triple row

Nbr of contacts
single row = 002 to 040
dual row = 004 to 080
triple row = 006 to 120

Plating
55 = Gold
other platings on request

2.00mm pitch Female Header
 - THT - 6.35mm profile right angle

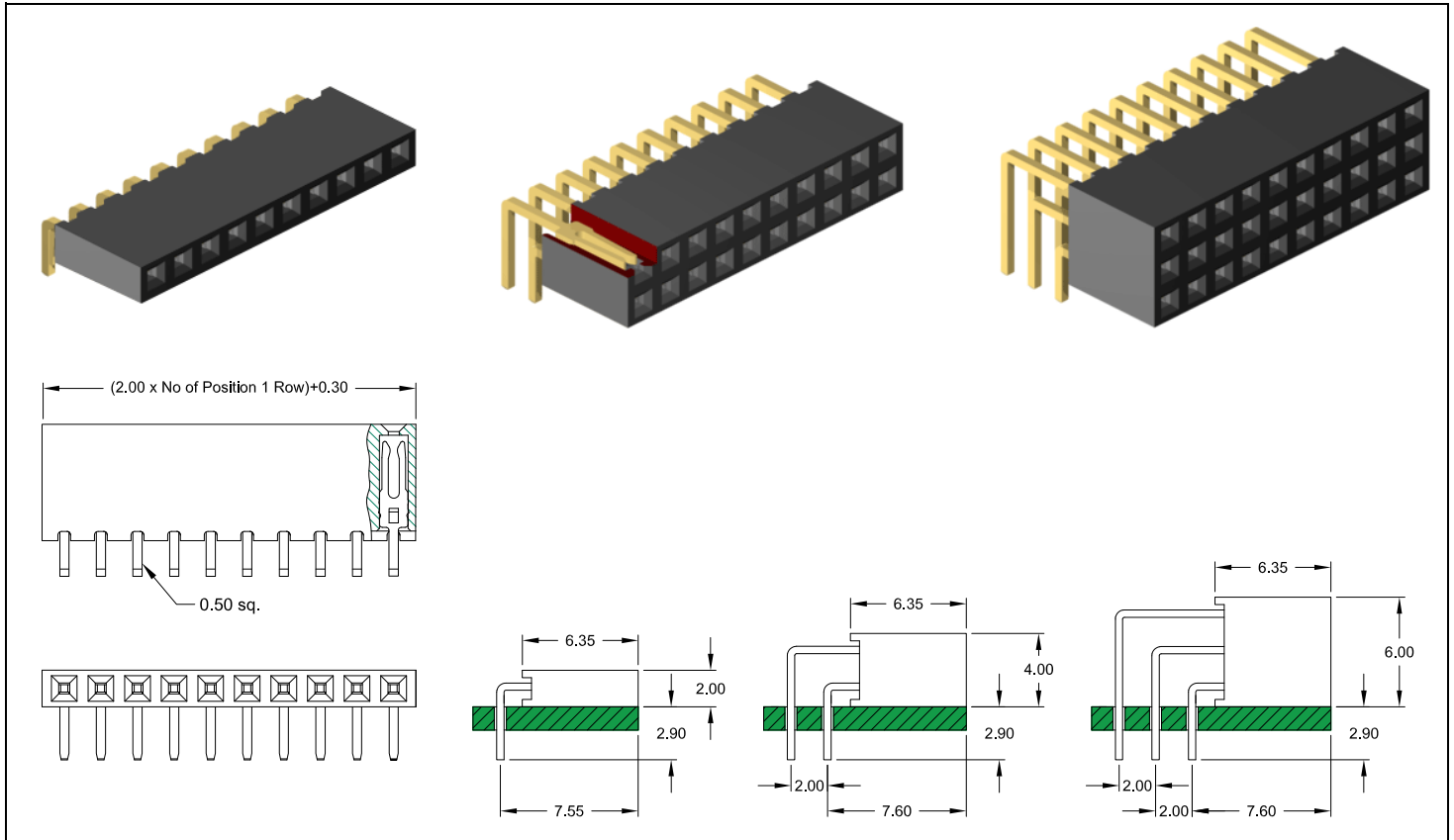

Application and Features

- For board-to-board connections
- Ideal solution for PC/104 Systems
- Accepts 0.50mm square pins
- Hi-rel fork contact design

PCB Hole Layout

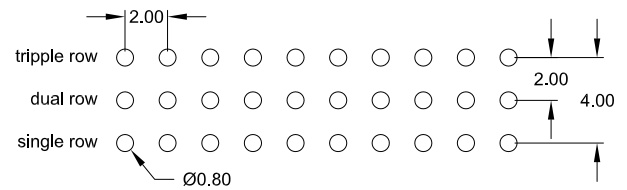

Specifications

Current rating	2 A	Operating temperature	- 40°C to +105°C
Insulation resistance	1000 MΩ min.	Contact material	(RoHS compliant) Copper Alloy
Contact resistance	20 mΩ max.	Insulator material	(RoHS compliant) LCP UL 94 V-0
Withstanding voltage	500 V AC		

How to order

BL x - xxx - RH635 - 55/2

Rows
1 = single row
2 = dual row
3 = triple row

Nbr of contacts
single row = 002 to 040
dual row = 004 to 080
triple row = 006 to 120

Plating
55 = Gold
other platings on request

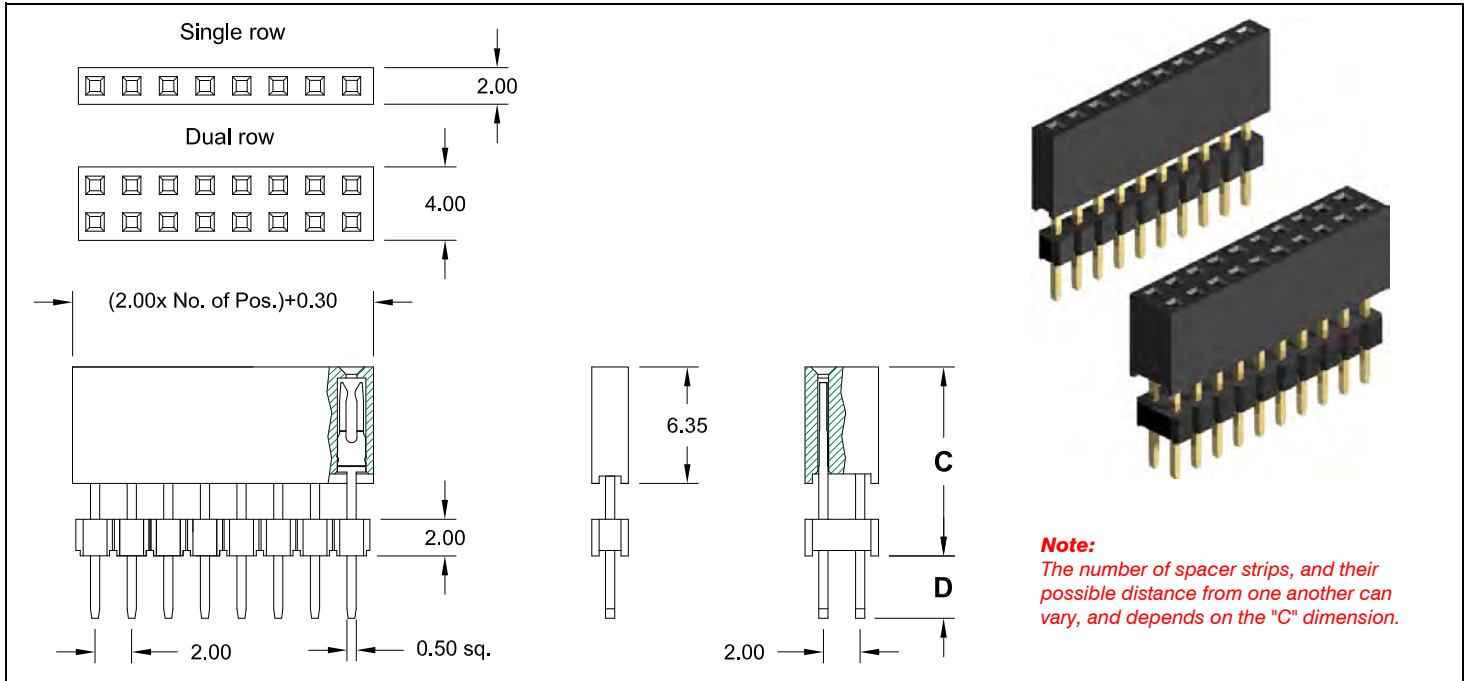

Application and Features

- Various heights for board-to-board connections
- Also ideal solution for PC/104 Systems
- Accepts 0.50 mm square pins
- Hi-rel fork contact design

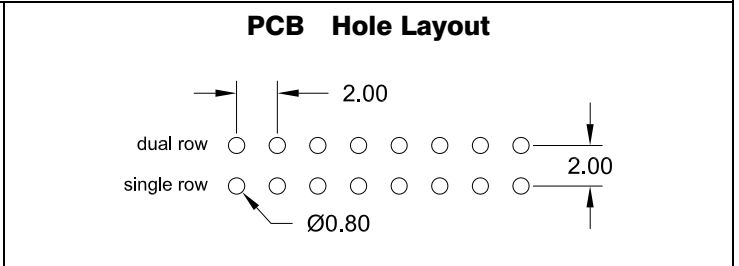

Specifications

Current rating	2 A	Operating temperature	- 40°C to +105°C
Insulation resistance	1000 MΩ min.	Contact material	Copper Alloy (RoHS compliant)
Contact resistance	20 mΩ max.	Insulator material	LCP (RoHS compliant) UL 94 V-0
Withstanding voltage	500 V AC		

How to order

BE x - xxx - S xxx - 55/2

Rows	Nbr of contacts
1 = single row	002 to 040
2 = dual row	004 to 080

Style	DIM "C"	DIM "D"
S 831	8.30 mm	3.40 mm
832	10.30 mm	3.20 mm
833	11.00 mm	2.30 mm
834	16.08 mm	2.30 mm
S 835	9.40 mm	2.30 mm
S 836	18.20 mm	3.40 mm
S 837	19.30 mm	2.30 mm
838	17.70 mm	2.80 mm
839	19.00 mm	2.50 mm
S 840	16.40 mm	5.20 mm
S 841	11.00 mm	10.60 mm
843	15.50 mm	3.50 mm
844	8.35 mm	2.80 mm
S 845	13.50 mm	8.10 mm
other dimensions on request		
"S" = available as Standard with "C" + "D" = 11.70mm & 21.60mm		

Plating
55 = Gold
other platings on request

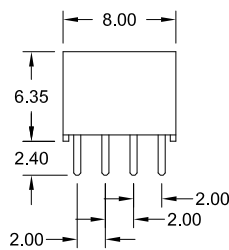
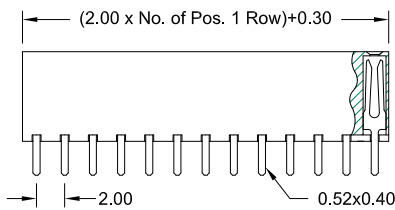
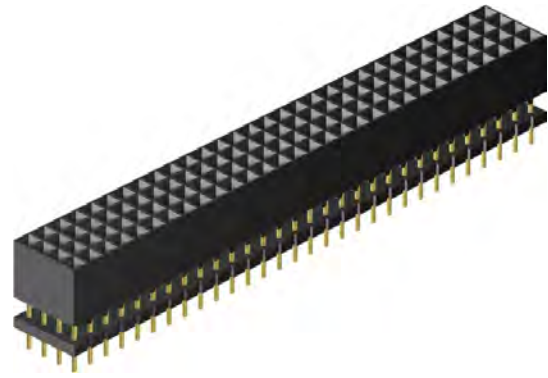
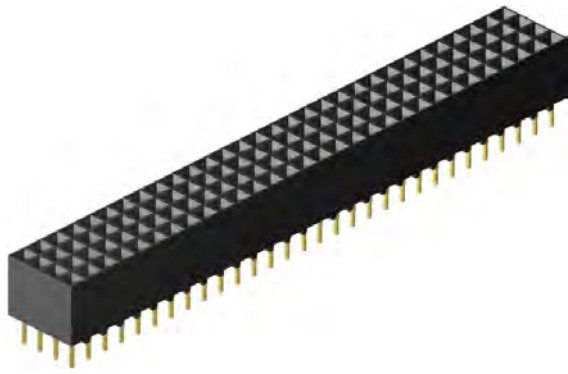

Style 630/0

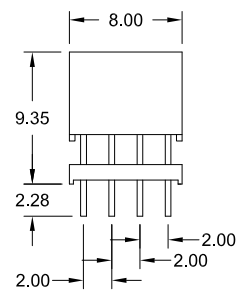
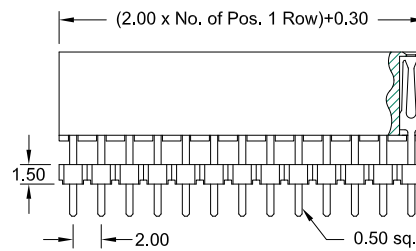

Style 630/1

Specifications

Current rating	2 A
Insulation resistance	1000 MΩ min.
Contact resistance	20 mΩ max.
Withstanding voltage	500 V AC
Operating temperature	- 40°C to +105°C
Contact material <i>(RoHS compliant)</i>	Phosphor Bronze
Insulator material <i>(RoHS compliant)</i>	LCP UL 94 V-0

PCB Hole Layout

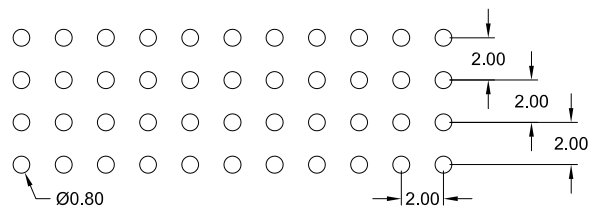

Application and Features

Low and high Profile PC/104-Plus Type
 Designed for "board to board" small spacing interconnection
 With standoff's for post solder cleaning
 Mate with Pin Header SL4 - xxx - S830/x - xx/2

How to order

BL4 - xxx - S xxx/x - 55/2

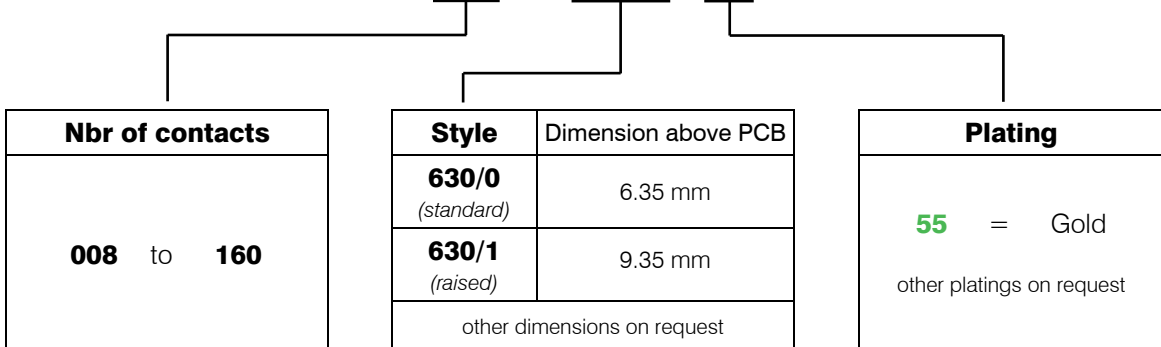

2.00mm pitch Female Header
 - THT - dual entry type low profile

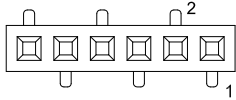
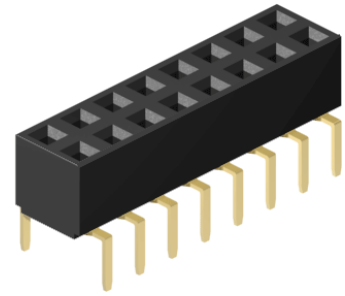
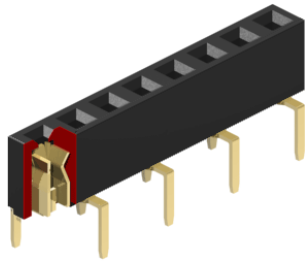

S430 Style

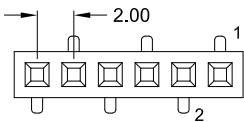

S431 Style

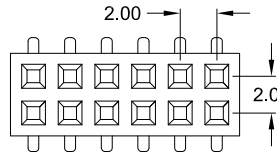

S430 Style

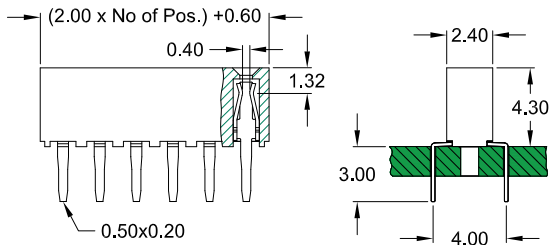

BB1-4xx-

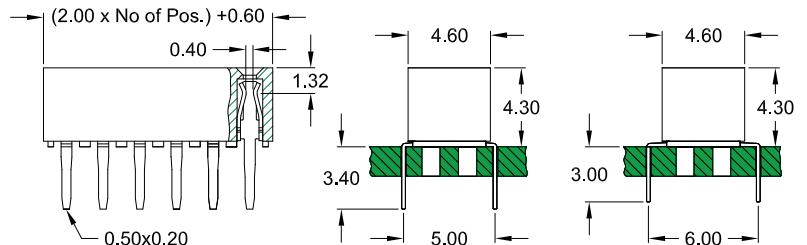

BB2-5xx-

BB2-6xx-

PCB Hole Layout

1 row - zig-zag pin-out

Style **S430**

Style **S431**

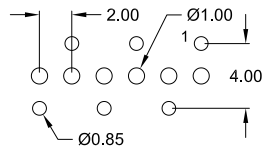
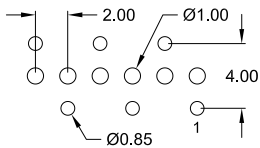

2 rows - pin spacing pin-out

5.00mm

6.00mm

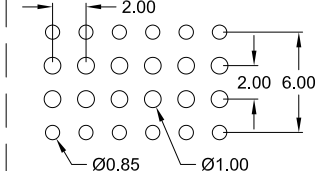
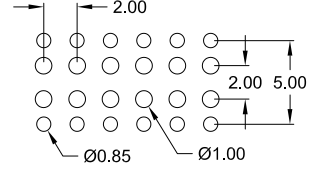

Application and Features

- Hi-rel dual beam contact assures reliable PCB connections
- Dual entry design for board stacking
- Accepts 0.50mm square pins

Specifications

Current rating	2 A
Insulation resistance	1000 MΩ min.
Contact resistance	20 mΩ max.
Withstanding voltage	500 V AC
Operating temperature	- 40°C to +105°C
Contact material (RoHS compliant)	Phosphor Bronze
Insulator material (RoHS compliant)	PA6T UL 94 V-0

How to order

BB x - x xx - S xxx - 55/2

Rows	Pin spacing	Nbr of contacts	Foot Style	Plating
1 = single row	4 = 4.00mm zig-zag	single row 02 to 40	single row 430 & 431 pls. choose 430 Style if odd pin count.	55 = Gold
2 = dual row	5 = 5.00 mm 6 = 6.00 mm	dual row 04 to 80	dual row 430	other plating on request

2.00mm pitch Female Header
 - THT - side entry type

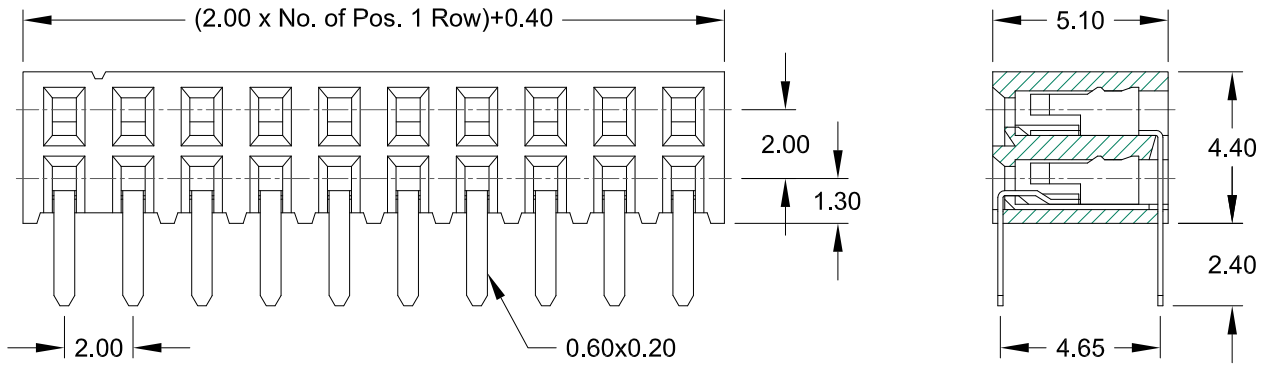
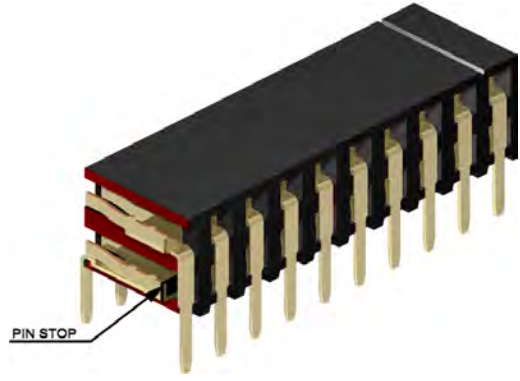
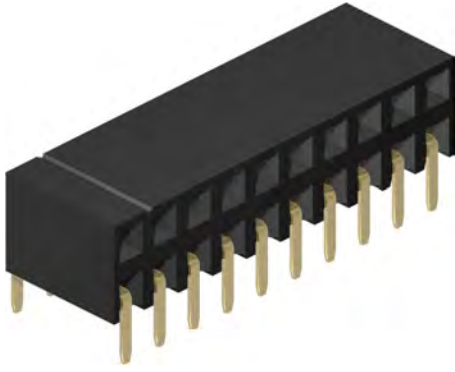

Application and Features

- **Standard: Tube packing**
- Hi-rel dual beam contact with "Pin Stop" assures reliable connections
- Accepts 0.50 mm square pins; Pin Header 2.00 mm x 2.00 mm
- 4.40 mm height above board
- Stand-off's facilitate post solder cleaning

PCB Hole Layout

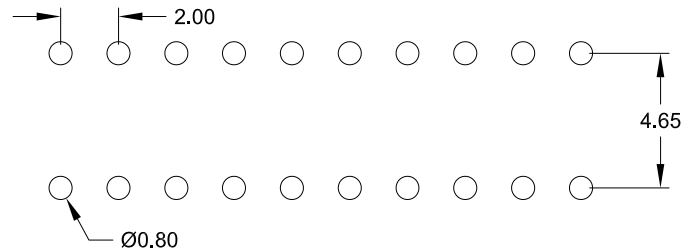

Specifications

Current rating	2 A
Insulation resistance	1000 M Ω min.
Contact resistance	20 m Ω max.
Withstanding voltage	500 V AC

Operating temperature	- 40°C to +105°C
Contact material	(RoHS compliant) Phosphor Bronze
Insulator material	(RoHS compliant) PA6T UL 94 V-0

How to order

BH2 - xxx - R450 - 55/2

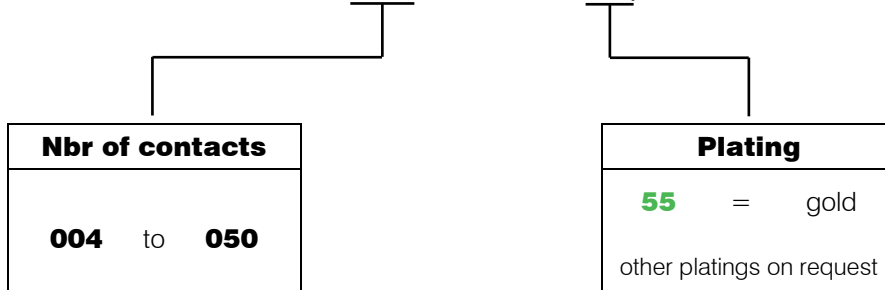

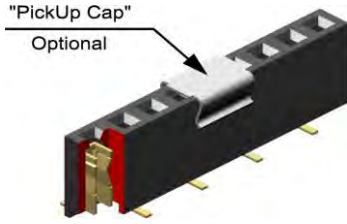

Foot Style

430

431

Style 430

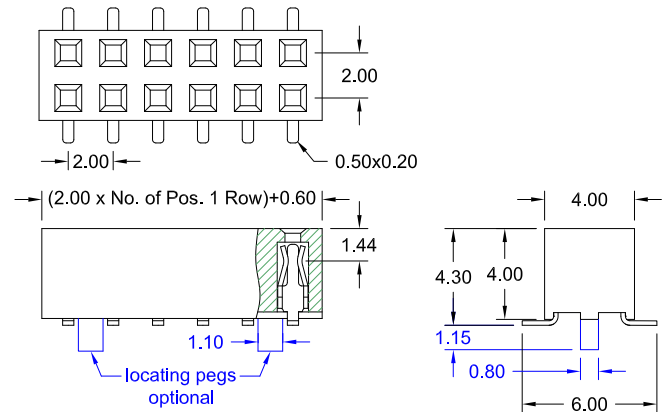
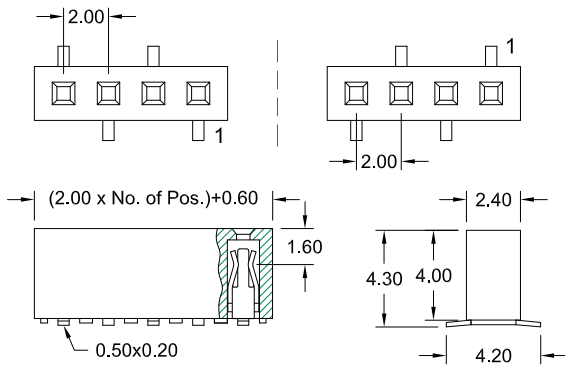

Application and Features

- **Standard: Tube packing and without "PickUp Cap"**
- Low profile, 4.30 mm height.
- Hi-rel dual beam contacts
- Mating with 2.00 mm pitch, 0.50 mm square, or round Pin Headers

PCB Surface Mount Layout

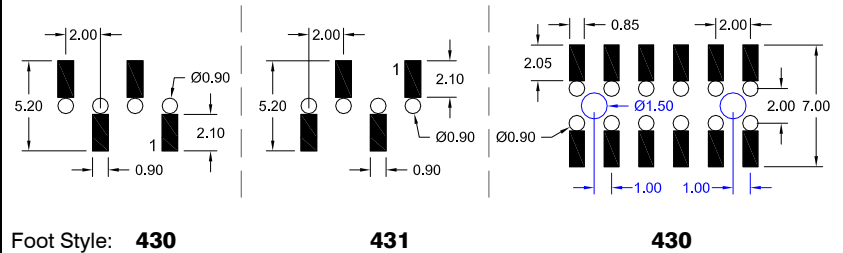

Specifications

Current rating	2 A	Operating temperature	- 40°C to +105°C
Insulation resistance	1000 MΩ min.	Processing temperature	+250°C +0/-5°C for 5sec.
Contact resistance	20 mΩ max.	Contact material	Phosphor Bronze (RoHS compliant)
Withstanding voltage	500 V AC	Insulator material	PA6T UL 94 V-0 (RoHS compliant)

How to order

BS x - xxx - H xxx - 55/2 X

Rows	Nbr of contacts	Foot Style	Plating	Options
1 single row	003 to 040	430 (standard) 431 (option) Pls. choose 430 Style if odd pin count	55 = Gold	A = Tube packing; with „PickUp Cap“ B = Reel packing; with „PickUp Cap“
2 dual row	006 to 080	430	other platings on request	without "locating pegs" A = Tube packing; with „PickUp Cap“ B = Reel packing; with „PickUp Cap“ with "locating pegs" C = Tube packing; without „PickUp Cap“ D = Tube packing; with „PickUp Cap“ E = Reel packing; with „PickUp Cap“

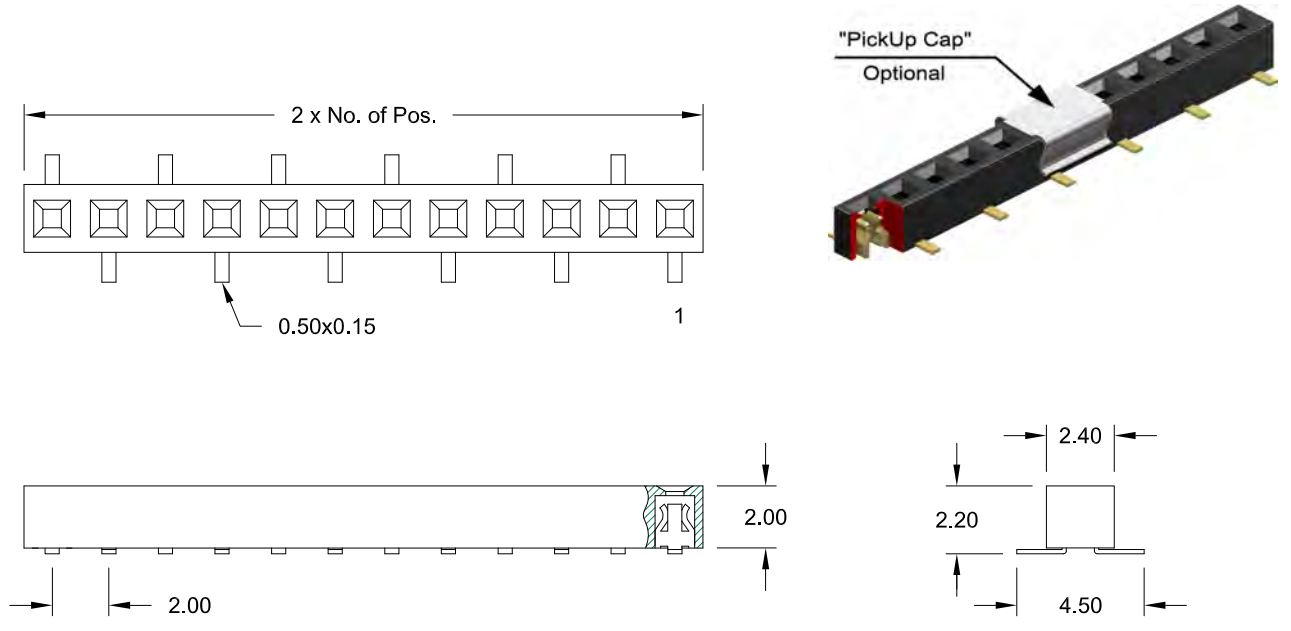

PCB Surface Mount & Hole Layout

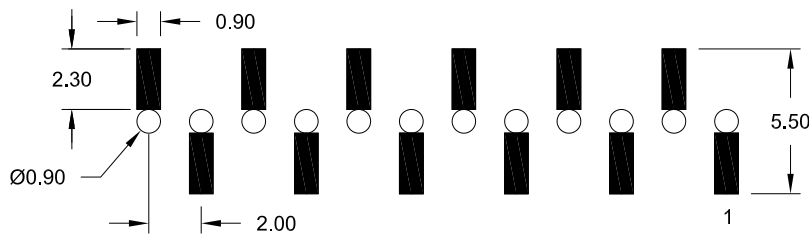

Application and Features

- **Standard: Tube packing and without "PickUp Cap"**
- Low profile, 2.20mm height above PCB available
- Mating with 2.00mm pitch, 0.50mm square, or round Pin Headers
- Designed for board to board small spacing interconnection

Specifications

Current rating	2 A
Insulation resistance	1000 MΩ min.
Contact resistance	20 mΩ max.
Withstanding voltage	500 V AC
Operating temperature	- 40°C to +105°C
Processing temperature	+250°C +0/-5°C for 5sec.
Contact material (RoHS compliant)	Phosphor Bronze
Insulator material (RoHS compliant)	PA6T UL 94 V-0

How to order

BS1 - xxx - TB 22 - 55/2 X

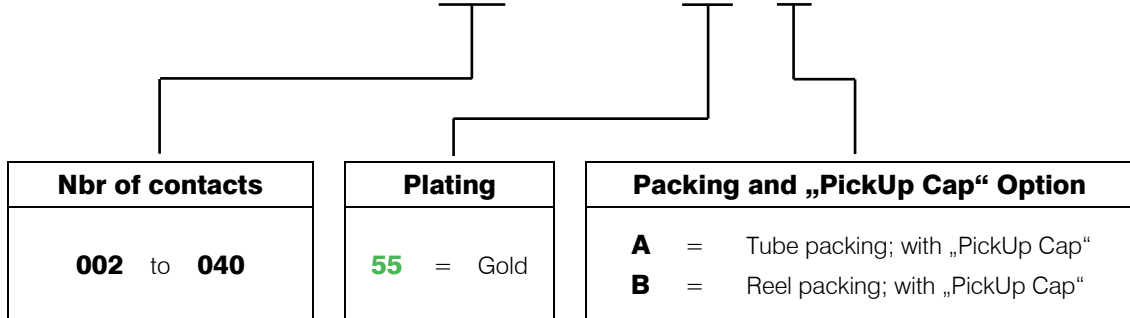

When using this female connector as a bottom entry connector, we recommend that the Pin Header pins protrude by around 2.00mm above the surface of the female connector after assembly. This will avoid any risk of separation of the Pin Header from the Female Header during shock and vibration.

2.00mm pitch Female Header - SMT – Top & Bottom Entry 2.20mm & 2.95mm profile

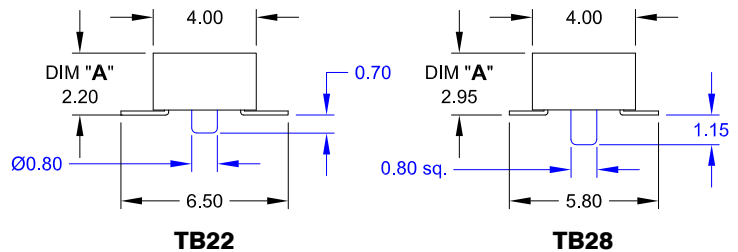
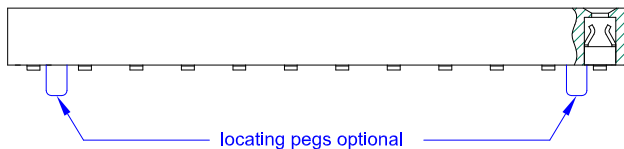
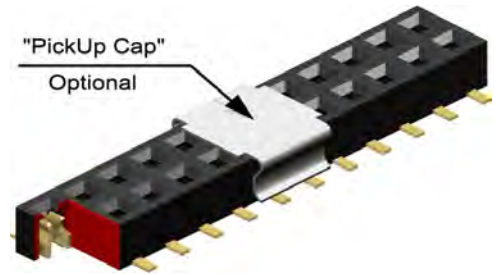
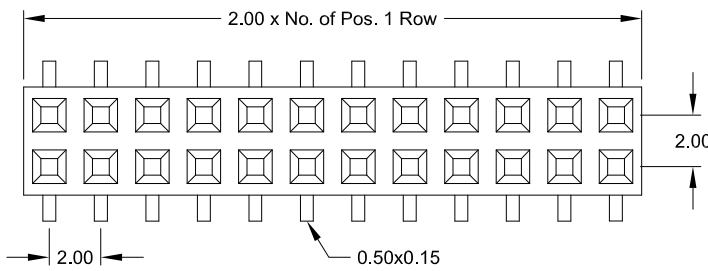

PCB Surface Mount & Hole Layout

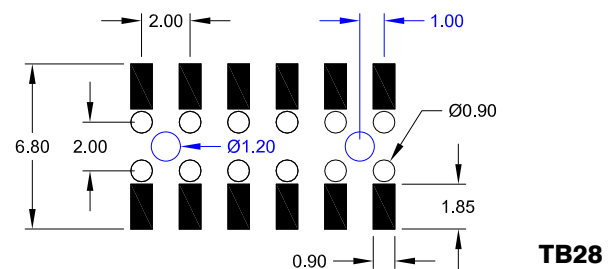
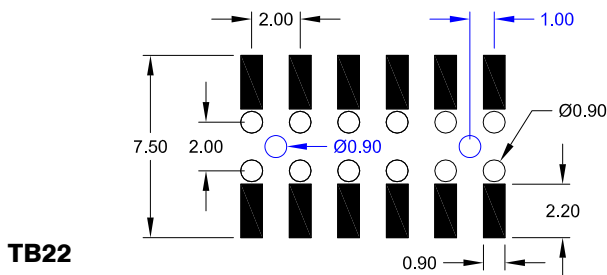

Application and Features

- **Standard: Tube packing, without "locating pegs" and without "PickUp Cap"**
- Low profile, 2.20mm and 2.95mm height above PCB available
- Mating with 2.00mm x 2.00mm pitch, 0.50mm square, or round Pin Headers
- Designed for board to board small spacing interconnection

Specifications

Current rating	2 A
Insulation resistance	1000 MΩ min.
Contact resistance	20 mΩ max.
Withstanding voltage	500 V AC
Operating temperature	- 40°C to +105°C
Processing temperature	+250°C +0/-5°C for 5sec.
Contact material	(RoHS compliant) Phosphor Bronze
Insulator material	(RoHS compliant) PA6T UL 94 V-0

How to order

BS2 - xxx - TB xx - 55/2 X

Nbr of contacts	Height Option	Plating	Options
006 to 080	22 DIM „A“ = 2.20 mm	55 = Gold	without "locating pegs"
006 to 070	28 DIM „A“ = 2.95 mm		A = Tube packing; with „PickUp Cap“ B = Reel packing; with „PickUp Cap“
			with "locating pegs"
			C = Tube packing; without „PickUp Cap“ D = Tube packing; with „PickUp Cap“ E = Reel packing; with „PickUp Cap“

When using this female connector as a bottom entry connector, we recommend that the Pin Header pins protrude by around 2.00mm above the surface of the female connector after assembly. This will avoid any risk of separation of the Pin Header from the Female Header during shock and vibration.

2.00mm pitch

Female Header

- SMT-

side entry

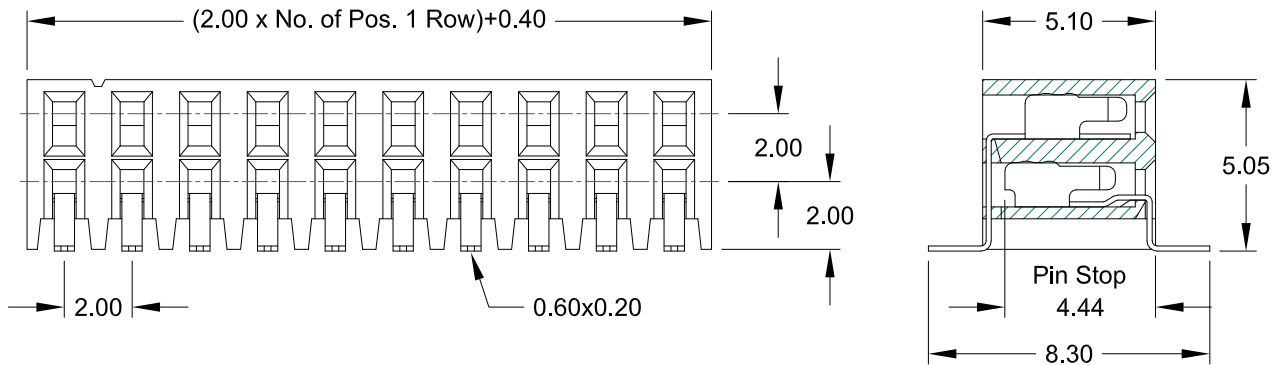
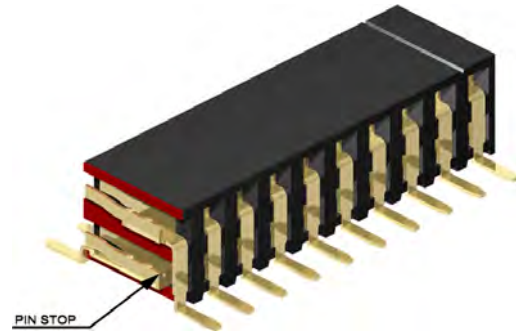
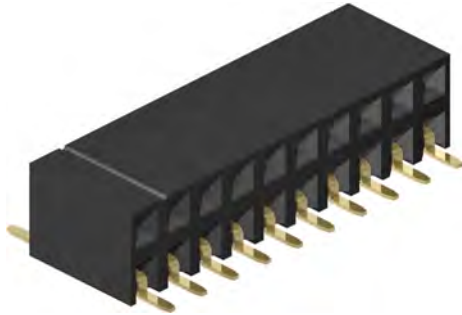

Application and Features

- **Standard: Tube packing**
- Hi-rel dual beam contact with "Pin Stop" assures reliable connections
- Accepts 0.50 mm square pins; Pin Header 2.00 mm x 2.00 mm
- 5.00 mm height above board
- Stand-off's facilitate post solder cleaning

PCB Surface Mount Layout

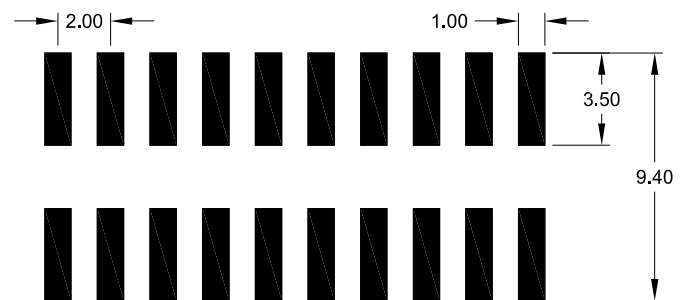

Specifications

Current rating	1 A	Operating temperature	- 40°C to +105°C
Insulation resistance	1000 MΩ min.	Processing temperature	+250°C +0/-5°C for 5sec.
Contact resistance	20 mΩ max.	Contact material (RoHS compliant)	Phosphor Bronze
Withstanding voltage	500 V AC	Insulator material (RoHS compliant)	PA6T UL 94 V-0

How to order

BS2 - xxx - R500 - 55/2 X

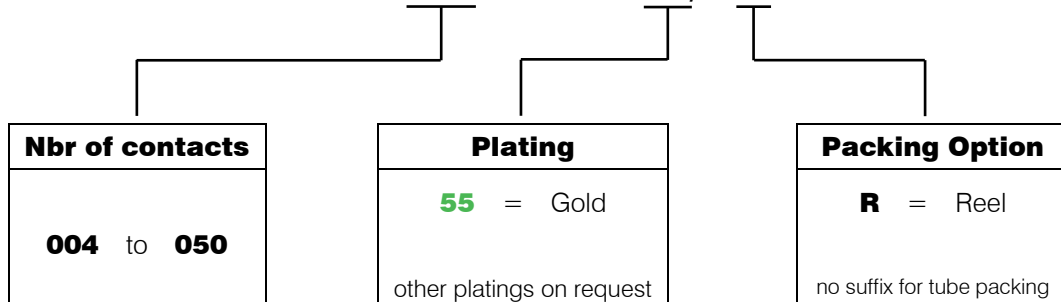

2.00mm pitch

IDC – Female Connector

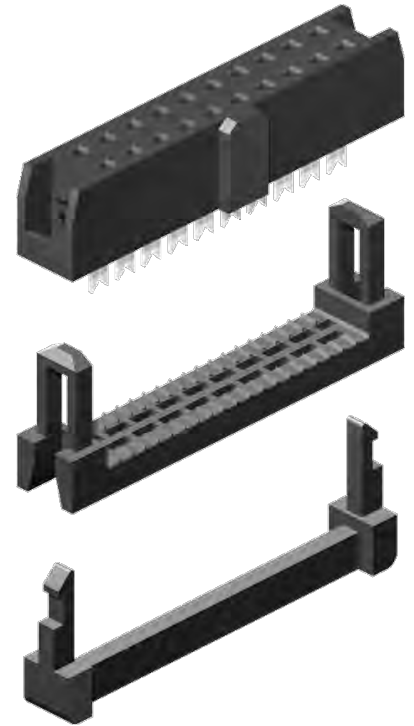
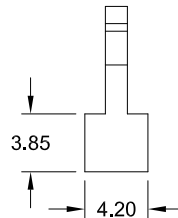
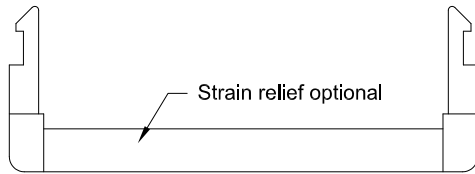
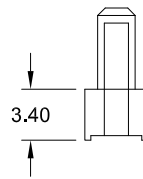
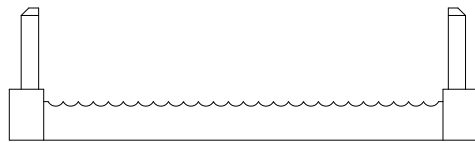
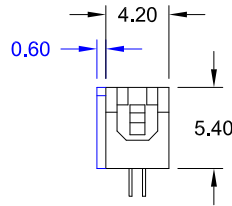
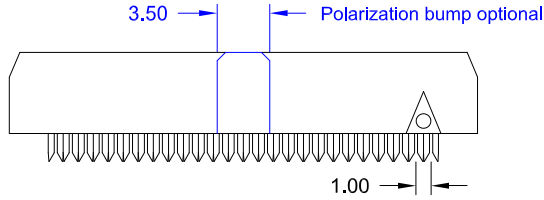
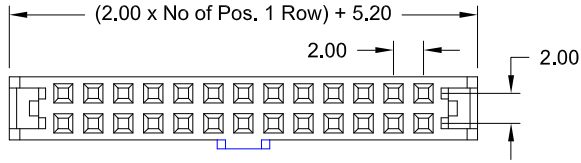

Specifications

Current rating	1 A	Operating temperature	- 40°C to +105°C
Insulation resistance	1000 MΩ min.	Contact material	(RoHS compliant) Copper alloy
Contact resistance	15 mΩ max.	Insulator material	(RoHS compliant) PBT (black) UL 94 V-0
Withstanding voltage	500 V AC		

Application and Features

Designed to mate with 0.50mm square pins Box Header

High Quality dual beam contacts

Accepts 26 & 28 AWG 1.00mm flat ribbon cable.

How to order

IDS - xxx - X 200 - N5 (/P)

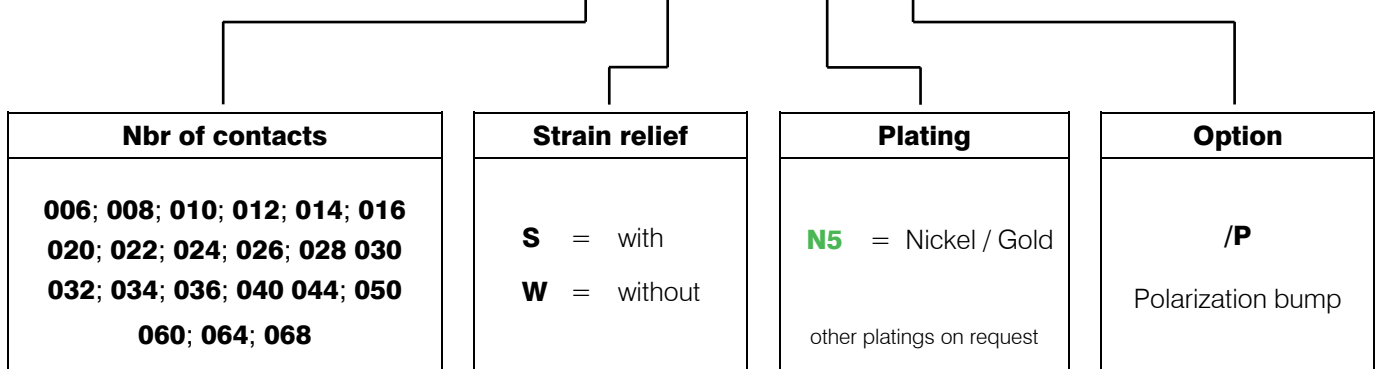

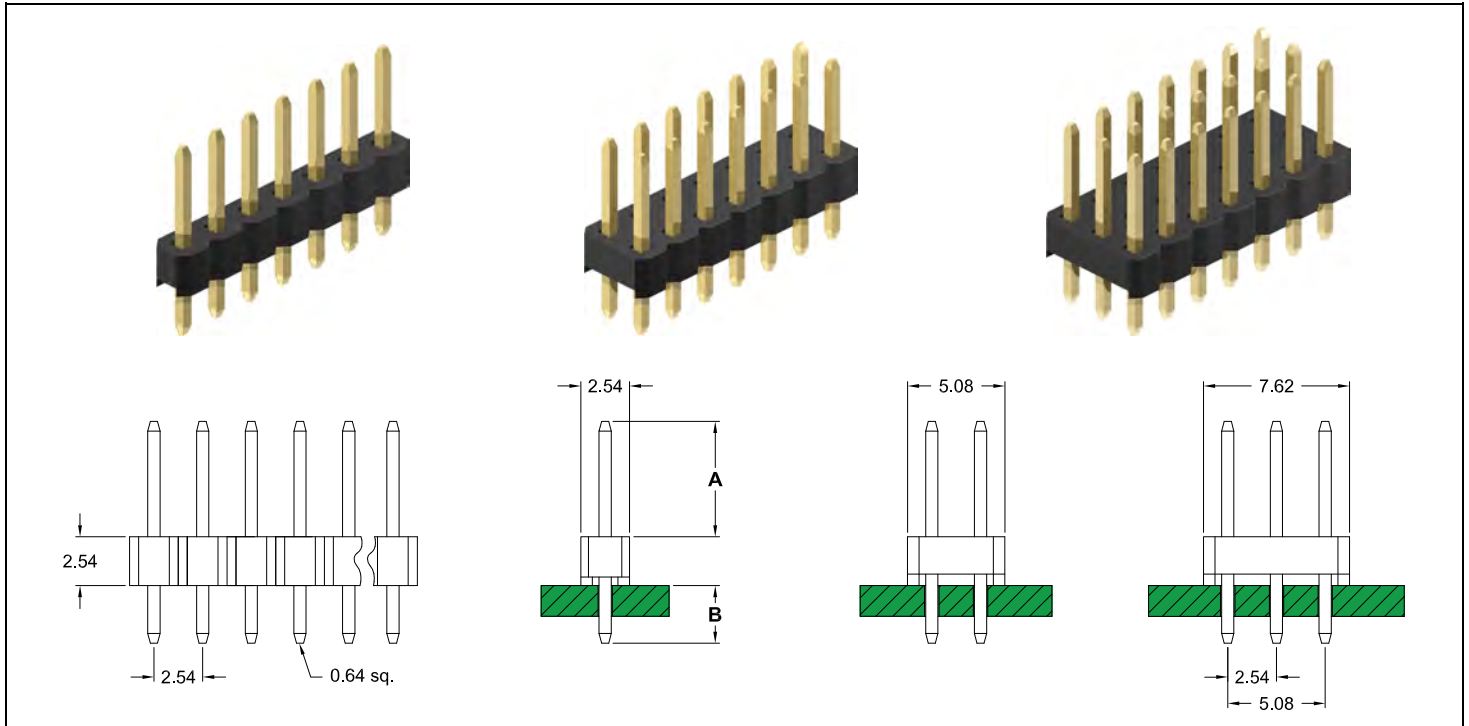

Pin code	DIM "A"	DIM "B"	Pin code	DIM "A"	DIM "B"	Pin code	DIM "A"	DIM "B"	Pin code	DIM "A"	DIM "B"	Pin code	DIM "A"	DIM "B"	Pin code	DIM "A"	DIM "B"
085/02	3,00	3,00	109/03	5,40	3,00	110/03	6,00	2,50	110/02	7,00	1,50	140/12	8,20	3,30	167/02	11,20	3,00
114/02	3,10	5,80	117/01	5,40	3,80	113/05	6,00	2,80	125/01	7,00	3,00	138/02	8,30	3,00	185/05	11,20	4,80
186/03	3,20	12,90	108/11	5,50	2,80	116/01	6,00	3,10	135/03	7,00	4,00	135/02	8,50	2,50	184/08	11,60	4,30
257/01	3,20	20,00	116/02	5,50	3,30	125/20	6,00	4,00	167/01	7,10	7,10	140/03	8,50	3,00	172/01	11,70	3,00
090/02	3,50	3,00	120/04	5,50	4,00	140/06	6,00	5,40	125/13	7,20	2,80	195/03	8,50	8,50	176/02	11,80	3,30
140/08	3,50	7,90	108/02	5,70	2,54	109/04	6,10	2,30	128/03	7,30	3,00	140/14	8,70	2,80	177/01	12,00	3,20
105/03	3,70	4,30	125/03	5,70	4,30	116/10	6,10	3,00	115/02	7,50	1,50	142/01	9,30	2,40	195/05	12,00	5,00
108/14	3,70	4,00	135/01	5,70	5,30	147/06	6,10	6,10	126/03	7,50	2,60	145/03	9,40	2,60	178/01	12,30	3,00
093/01	3,80	3,00	139/01	5,70	5,70	108/03	6,30	2,00	136/07	7,50	3,60	147/12	9,50	2,70	271/01	12,30	12,30
085/08	4,00	2,00	184/12	5,70	10,20	113/06	6,50	2,30	140/16	7,50	4,00	154/03	9,60	3,30	177/02	12,40	2,80
095/02	4,00	3,00	209/03	5,70	12,70	118/05	6,50	2,80	175/02	7,50	7,50	155/08	10,00	3,00	186/01	12,40	3,80
095/01	4,20	2,80	216/01	5,70	13,40	120/05	6,50	3,00	134/01	7,70	3,20	175/06	10,00	5,00	218/02	12,50	6,80
105/05	4,20	3,60	240/01	5,70	15,75	122/05	6,50	3,20	184/11	7,90	7,90	190/05	10,00	6,50	184/02	12,60	3,00
108/10	4,30	4,00	267/01	5,70	18,50	109/05	6,60	1,80	125/08	8,00	1,80	209/04	10,20	8,20	185/01	12,70	3,30
100/07	4,50	3,00	106/02	5,80	2,30	123/01	6,60	3,20	135/08	8,00	3,00	160/10	10,50	3,00	184/06	12,80	3,10
108/07	4,50	3,80	113/02	5,80	3,00	125/10	6,60	3,40	140/13	8,00	3,50	163/02	10,70	3,10	216/07	12,80	6,30
118/04	4,50	4,80	114/03	5,80	3,10	125/04	6,70	3,30	137/01	8,10	3,10	155/06	10,80	2,20	184/01	12,90	3,00
100/04	5,00	2,50	116/07	5,80	3,30	159/03	6,70	6,70	164/04	8,10	5,80	165/01	10,80	3,20	345/01	12,90	19,00
105/01	5,00	3,00	185/03	5,80	10,20	126/01	6,80	3,30	191/03	8,10	8,50	164/02	10,90	3,00	180/12	13,00	2,50
102/02	5,20	2,50	312/04	5,80	22,90	138/03	6,80	4,50	138/01	8,16	3,10	165/03	11,00	3,00	185/04	13,00	3,00
187/04	5,20	11,00	105/04	6,00	2,00	125/15	6,90	3,10	135/10	8,20	2,80	178/03	11,00	4,30	215/03	13,00	6,00

all dimension mm

Standard dimension & pin code

Many other dimensions available on request

Specifications

Current rating	3 A	Operating temperature	- 40°C to +105°C
Insulation resistance	1000 MΩ min.	Contact material (RoHS compliant)	Brass
Withstanding voltage	500 V AC	Insulator material (RoHS compliant)	PBT or PA6T UL 94 V-0 Standard : PBT

How to order

SL x - xxx - X xxx/xx - 55

Rows	Nbr of pins	Insulator	Pin code	Plating
1 = single row	single row = 002 to 040	S = PBT	see above table	55 = Gold (standard)
2 = dual row	dual row = 004 to 080	SH = PA6T		99 = Tin (leadfree)
3 = triple row	triple row = 009 to 120			95 = Tin/Gold (tin leadfree)
				other platings on request

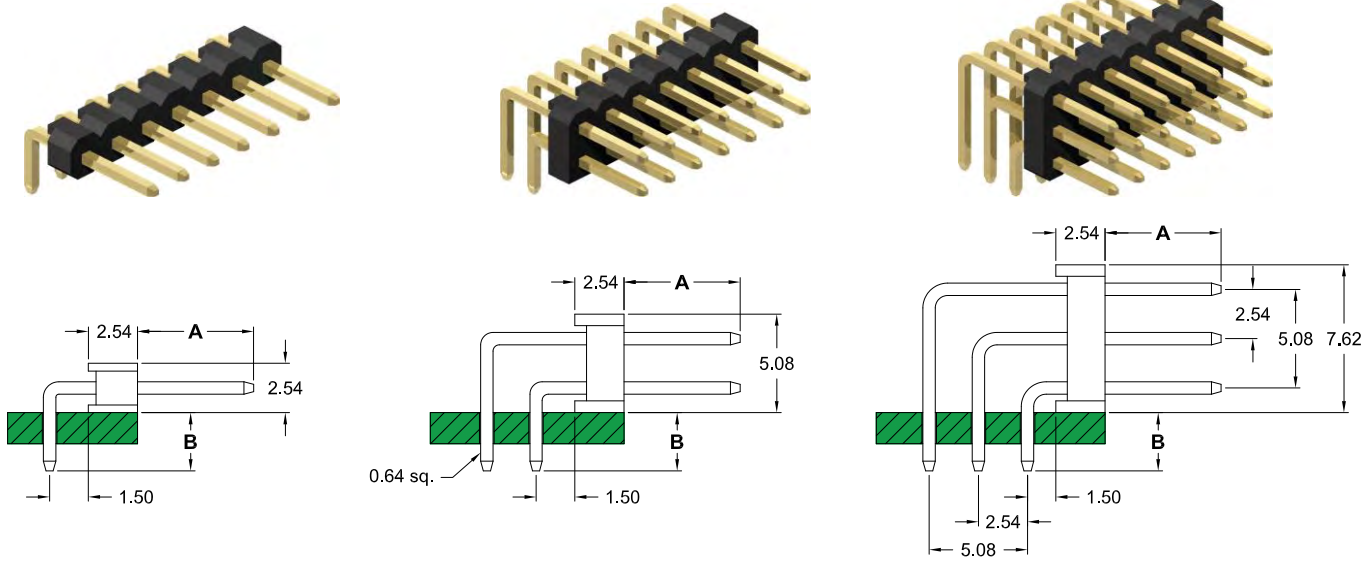

Down angle Pin Style

Pin code	DIM "A"	DIM "B"	Pin code	DIM "A"	DIM "B"	Pin code	DIM "A"	DIM "B"	Pin code	DIM "A"	DIM "B"	Pin code	DIM "A"	DIM "B"	Pin code	DIM "A"	DIM "B"
078/03	1,40	1,40	120/06	4,00	3,00	141/01	5,80	4,80	140/03	7,00	2,00	159/04	8,20	3,00	251/01	10,00	10,00
093/04	2,50	1,40	120/01	4,50	2,50	211/07	5,80	9,90	145/04	7,00	2,40	203/06	8,23	7,00	184/09	10,40	3,30
100/03	2,50	2,50	125/07	4,50	3,30	258/02	5,80	15,00	147/01	7,00	3,00	246/01	8,30	11,70	186/01	10,70	3,30
103/01	2,75	2,75	125/06	4,70	3,15	159/01	5,90	5,11	176/01	7,00	6,00	159/02	8,50	2,54	203/05	12,00	3,30
105/02	2,80	3,00	147/04	4,80	5,11	201/01	5,90	9,40	147/03	7,40	2,54	165/02	8,60	3,30	230/07	12,00	6,00
106/01	2,80	2,80	125/09	5,30	2,54	125/16	6,00	2,00	133/03	7,50	1,50	169/01	8,60	3,30	203/03	12,50	3,00
116/03	3,00	3,00	133/02	5,30	3,30	135/12	6,00	2,50	136/06	7,50	2,54	158/02	8,80	2,00	203/02	13,00	2,54
108/01	3,00	4,00	125/11	5,60	2,10	140/01	6,00	3,00	140/04	7,80	1,50	170/02	8,80	3,30	209/01	13,10	3,00
113/07	3,00	7,00	132/01	5,70	2,50	171/02	6,00	3,60	155/05	7,80	3,00	165/01	9,00	2,54	216/03	13,60	3,30
151/02	3,20	3,00	133/01	5,70	2,85	312/06	6,00	10,00	162/03	8,00	3,20	184/05	9,40	4,60	230/05	15,00	3,00
122/04	3,20	3,90	137/03	5,70	3,00	140/09	6,20	3,15	136/01	8,00	3,60	176/03	9,70	3,15			
106/02	3,30	2,30	155/02	5,70	5,11	138/01	6,50	2,60	184/04	8,00	5,80	203/04	9,70	5,80			
117/02	3,40	3,20	260/06	5,70	15,30	149/01	6,70	3,20	187/02	8,00	6,00	166/01	9,90	1,60			
111/01	3,50	2,75	126/02	5,80	2,30	148/01	6,75	2,90	160/11	8,10	2,80	181/01	9,90	3,20			
111/02	3,50	3,50	134/02	5,80	2,50	213/01	6,80	9,50	182/01	8,10	5,10	250/02	9,90	10,00			
116/04	3,60	2,54	140/05	5,80	3,60	150/07	6,90	3,00	157/02	8,13	2,54	180/05	9,96	3,30			
108/02	3,70	3,00	140/11	5,80	3,00	147/02	6,90	3,30	155/04	8,20	2,54	170/03	10,00	2,00			

all dimension mm

Standard dimension & pin code

Many other dimensions available on request

Up angle Pin Style

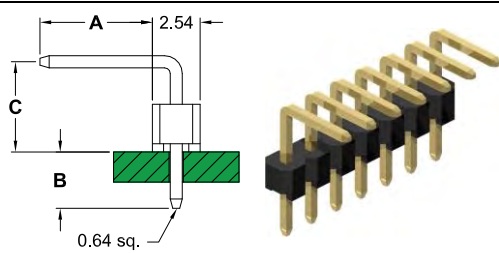

Pin code	DIM "A"	DIM "B"	DIM "C"	Pin code	DIM "A"	DIM "B"	DIM "C"	Pin code	DIM "A"	DIM "B"	DIM "C"
151/01	3,30	7,00	7,00	170/04	5,50	3,40	7,10	130/01	7,00	2,54	3,00
170/01	3,30	8,60	8,60	135/11	6,00	3,00	3,50	150/05	7,00	3,00	4,00
190/02	3,30	10,60	10,60	147/07	6,00	3,00	4,80	184/15	7,00	3,00	6,35
115/01	3,50	2,60	3,00	160/05	6,00	3,00	6,04	181/02	7,90	3,20	6,00
114/01	4,00	3,00	2,60	175/03	6,00	3,00	7,54	184/06	8,00	3,60	6,30
120/05	4,00	3,10	3,00	155/03	6,20	2,54	6,30	172/02	9,45	2,40	4,30
190/01	4,25	3,00	3,00	160/03	6,20	2,35	3,70	150/06	8,20	3,00	2,86
155/09	5,10	3,00	3,10	140/13	6,40	3,40	3,15	149/02	9,70	1,50	2,80

Specifications: Refer to straight Pin Headers

Many other dimensions available on request

How to order

SL x - xxx - X xxx/xx - 55

Rows	Nbr of pins	Pin style & Insulator	Pin code	Plating
<p>1 = single row</p> <p>2 = dual row</p> <p>3 = triple row</p>	<p>single row = 002 to 040</p> <p>dual row = 004 to 080</p> <p>triple row = 009 to 120</p>	<p>R = Down angle (PBT Insulator)</p> <p>RH = Down angle (PA6T Insulator)</p> <p>U = Up angle (PBT Insulator)</p> <p>UH = Up angle (PA6T Insulator)</p>	<p>see above table</p>	<p>55 = Gold (standard)</p> <p>99 = Tin (leadfree)</p> <p>95 = Tin/Gold (tin leadfree)</p> <p>other platings on request</p>

2.54mm pitch Pin Header
 - THT - high plastic base



straight Style - 7.40mm body

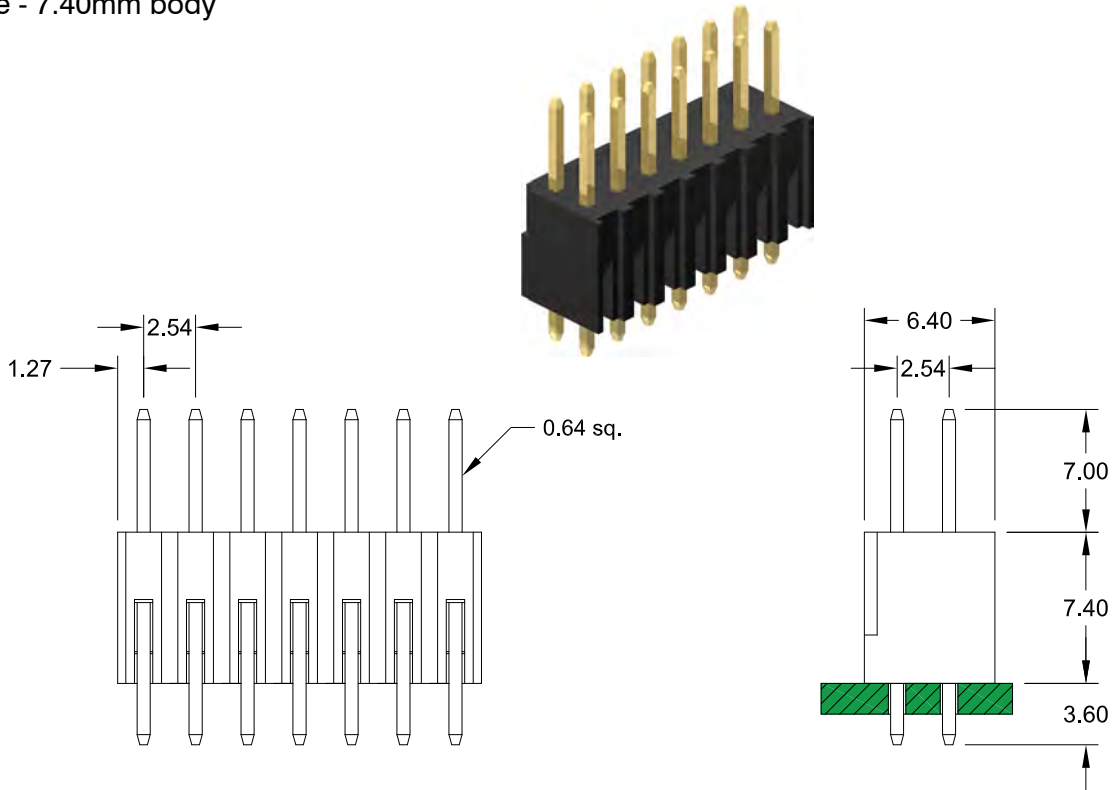

S740

right angle Style - 6.35mm body

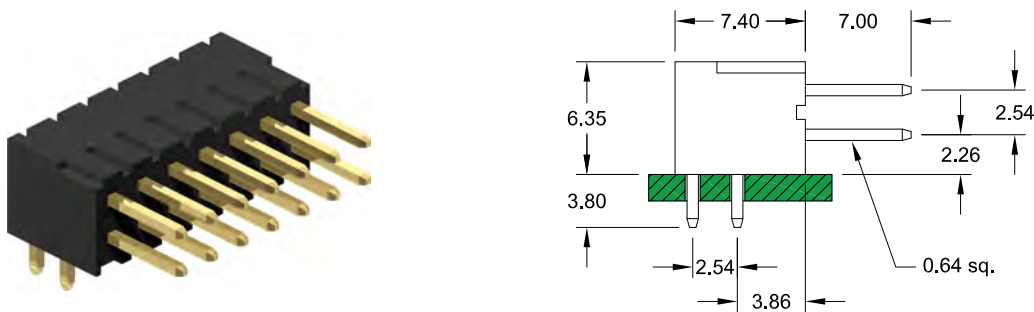

R635

Specifications

Current rating	3 A
Insulation resistance	1000 MΩ min.
Withstanding voltage	500 V AC
Operating temperature	- 40°C to +105°C
Contact material	Brass
Insulator material	PBT UL 94 V-0

PCB Hole Layout

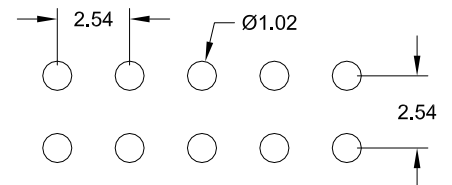

How to order

SE2 - xxx - Xxxx - 55

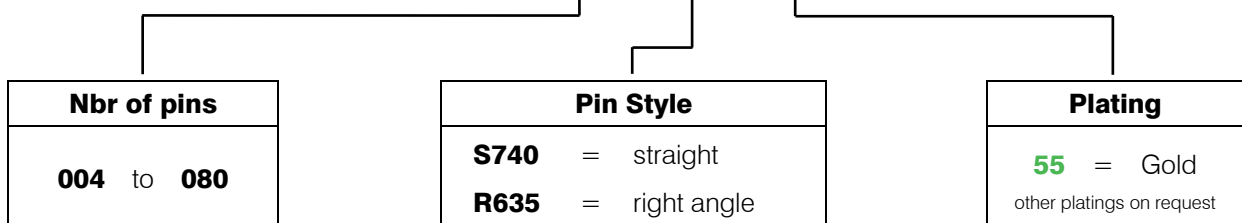

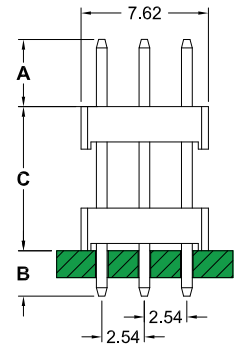
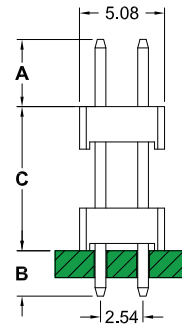
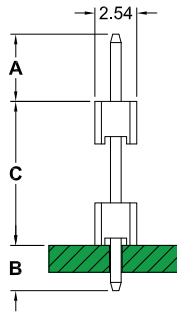
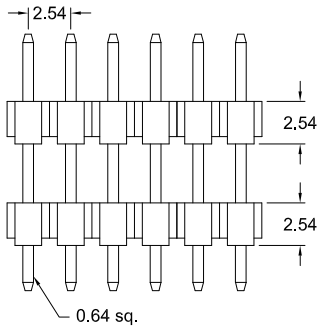
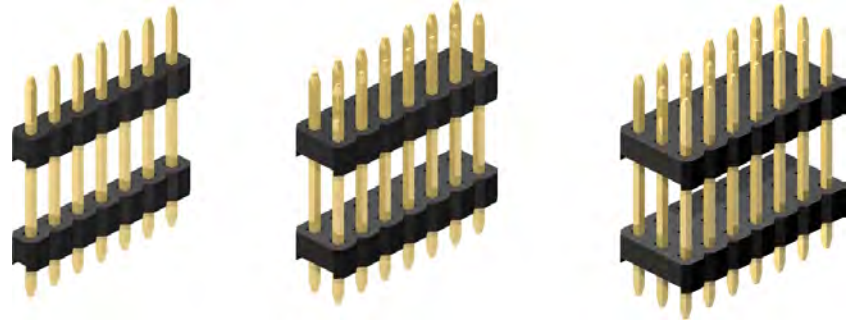

Pin Style

Pin code	DIM "A"	DIM "B"	DIM "C"	Pin code	DIM "A"	DIM "B"	DIM "C"	Pin code	DIM "A"	DIM "B"	DIM "C"	Pin code	DIM "A"	DIM "B"	DIM "C"	Pin code	DIM "A"	DIM "B"	DIM "C"
141/15	7,40	3,20	3,50	147/08	3,00	3,00	8,70	228/02	6,50	3,30	13,00	249/02	5,10	3,30	16,50	302/01	6,80	2,50	20,90
108/15	3,00	3,00	4,80	171/01	4,80	3,30	9,00	249/07	8,80	2,50	13,60	308/05	11,30	3,00	16,50	270/05	3,00	3,00	21,00
110/04	3,00	3,00	5,00	180/01	6,00	3,00	9,00	200/03	3,00	3,00	14,00	270/03	7,20	3,00	16,80	316/02	7,60	3,00	21,00
249/04	16,60	3,30	5,00	249/11	13,00	2,90	9,00	230/01	6,00	3,00	14,00	263/02	6,60	2,80	16,90	276/01	3,20	3,20	21,20
141/03	6,00	3,00	5,10	177/05	4,90	3,30	9,50	262/04	9,20	2,80	14,20	317/01	6,50	3,20	17,00	318/01	7,50	3,00	21,30
185/07	10,60	2,80	5,10	211/05	8,20	3,30	9,60	235/02	5,80	3,00	14,70	273/01	6,60	3,20	17,50	342/05	9,20	3,00	22,00
125/14	4,00	3,00	5,50	190/03	6,00	3,30	9,70	290/06	11,30	3,00	14,70	300/01	9,50	3,00	17,50	290/15	3,30	3,30	22,40
116/06	2,80	2,80	6,00	240/07	11,00	3,30	9,70	212/01	3,10	3,10	15,00	312/05	10,90	2,80	17,50	320/02	6,00	3,00	23,00
189/01	9,50	3,00	6,40	160/01	3,00	3,00	10,00	260/03	8,00	3,00	15,00	260/02	5,00	3,30	17,70	340/03	8,00	3,00	23,00
135/11	3,50	3,50	6,50	194/01	6,40	3,00	10,00	266/02	8,60	3,00	15,00	262/03	5,60	2,80	17,80	378/05	11,00	3,30	23,50
147/10	4,90	3,30	6,50	230/03	10,00	3,00	10,00	283/01	10,00	3,30	15,00	249/03	3,60	3,30	18,00	323/01	5,50	2,80	24,00
159/07	6,00	3,30	6,60	207/01	7,00	3,10	10,60	378/06	19,80	2,80	15,20	263/01	5,50	2,80	18,00	340/06	7,00	3,00	24,00
140/15	4,50	2,50	7,00	183/02	3,60	3,70	11,00	274/02	8,70	3,30	15,40	280/03	7,00	3,00	18,00	450/01	18,00	3,00	24,00
180/09	8,00	3,00	7,00	219/02	7,30	3,30	11,30	215/01	3,00	3,00	15,50	378/04	16,50	3,30	18,00	312/01	3,40	3,40	24,50
200/02	10,00	3,00	7,00	177/04	3,00	3,25	11,40	285/01	10,00	3,00	15,50	250/03	3,00	3,00	19,00	360/02	8,00	3,00	25,00
160/03	5,80	2,80	7,40	216/10	6,50	3,60	11,50	270/07	8,50	3,00	15,50	290/07	6,70	3,30	19,00	340/02	5,30	3,00	25,70
135/09	3,00	3,00	7,50	288/01	14,40	2,80	11,60	308/01	12,00	3,30	15,50	290/12	7,00	3,00	19,00	312/02	2,60	2,60	26,00
144/01	3,20	3,20	8,00	180/02	3,00	3,00	12,00	248/01	6,10	3,00	15,70	279/01	5,10	3,30	19,50	358/02	5,90	3,60	26,30
173/01	6,00	3,30	8,00	225/03	7,50	3,00	12,00	261/99	7,60	2,80	15,70	290/14	6,00	3,00	20,00	342/04	5,00	2,80	26,40
360/03	25,00	3,00	8,00	260/08	11,00	3,00	12,00	220/01	3,00	3,00	16,00	340/08	10,70	3,30	20,00	330/01	3,00	3,00	27,00
185/12	7,60	2,80	8,10	211/01	6,00	2,90	12,20	238/02	5,00	2,80	16,00	362/03	13,00	3,20	20,00	365/03	6,50	3,00	27,00
186/05	6,60	3,60	8,40	180/10	2,70	2,70	12,60	250/04	6,00	3,00	16,00	400/03	17,00	3,00	20,00	340/99	3,00	3,00	28,00
155/11	3,50	3,50	8,50	177/02	2,50	2,50	12,70	296/01	10,60	3,00	16,00	265/04	3,10	3,10	20,30	378/03	6,50	3,30	28,00
210/03	9,00	3,50	8,50	190/04	3,00	3,00	13,00	244/01	5,30	2,60	16,50	288/03	5,30	2,80	20,70	390/02	8,00	3,00	28,00

all dimensions mm

Many other dimensions available on request

Specifications

Current rating	3 A	Operating temperature	- 40°C to +105°C
Insulation resistance	1000 MΩ min.	Contact material (RoHS compliant)	Brass
Withstanding voltage	500 V AC	Insulator material (RoHS compliant)	PBT or PA6T UL 94 V-0
			Standard : PBT

How to order

SP x - xxx - S xxx/xx - xx

Rows	Nbr of pins	Insulator	Pin code	Plating
1 = single row	single row = 002 to 040	S = PBT	see above table	55 = Gold (standard)
2 = dual row	dual row = 004 to 080	SH = PA6T		99 = Tin (leadfree)
3 = triple row	triple row = 009 to 120			95 = Tin/Gold (tin leadfree)
				other platings on request

2.54mm pitch Pin Header
- SMT - single & dual row

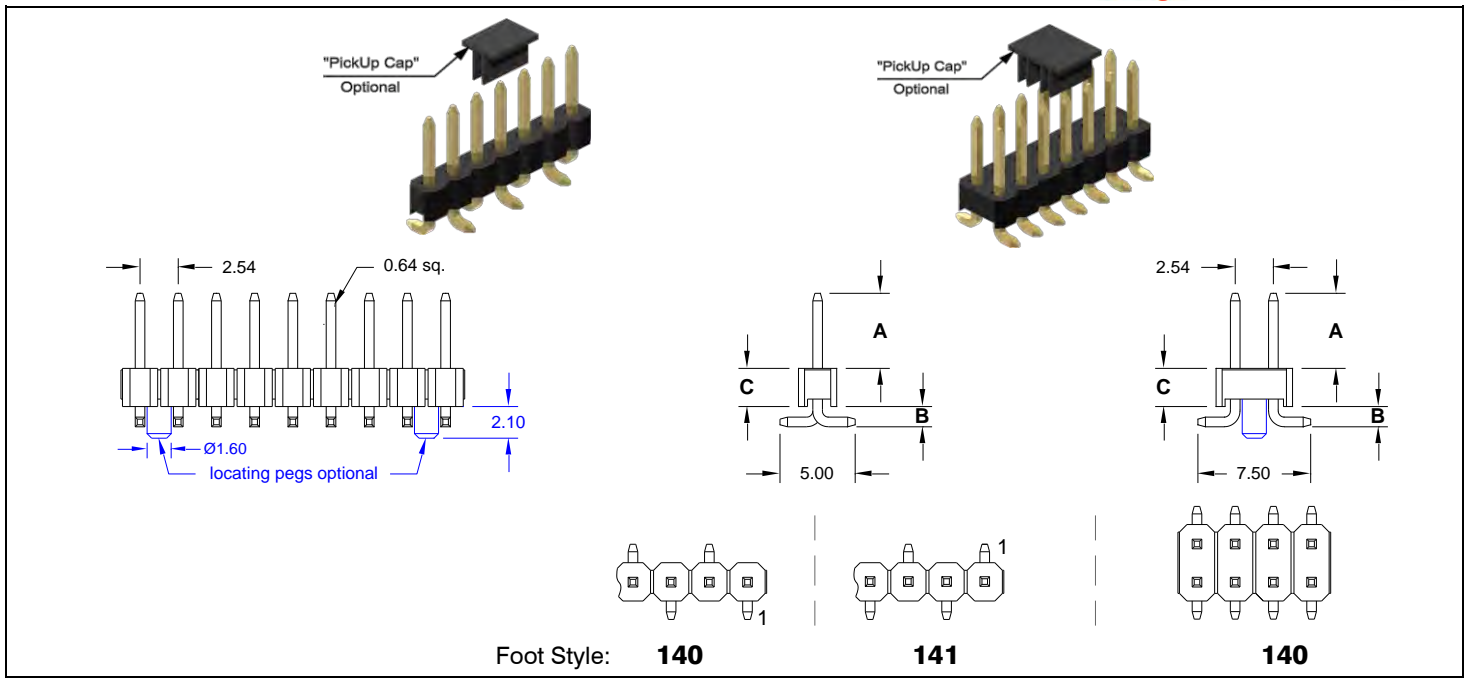

Foot Style: **140**

141

140

Application and Features

- **Standard: Tube packing and without "PickUp Cap"**
- Standard Pin code **01**, many pin dimensions on request
- Mating with 2.54mm Female Headers

PCB Surface Mount Layout

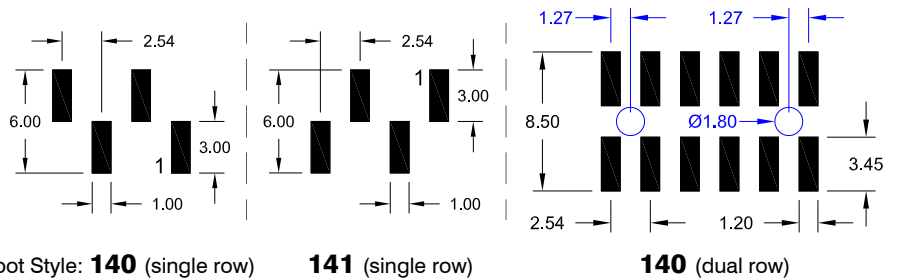

Foot Style: **140** (single row)

141 (single row)

140 (dual row)

Specifications

Current rating	3 A	Operating temperature	- 40°C to +105°C
Insulation resistance	1000 MΩ min.	Processing temperature	+250°C +0/-5°C for 5sec.
Withstanding voltage	500 V AC	Contact material	(RoHS compliant) Brass
		Insulator material	(RoHS compliant) PA6T UL 94 V-0

How to order

SS x - xxx - X 14x / xx - 55 X

Rows	Nbr of pins	Insulator Style	Foot Style	Pin code	DIM "A"	DIM "B"	DIM "C"	Plating	Options
1 single row	002 to 040	H (=Standard) if DIM"C"=2.54mm	140 141 Pls. choose 140 style if odd pin count.	00	5.00	1.00	1.50	55 = Gold other platings on request	without "locating pegs" A = Tube packing; with „PickUp Cap“ B = Reel packing; with „PickUp Cap“
				01	6.00	1.82	2.54		
2 dual row	004 to 080	TH if DIM"C"=1.50mm Please note: 1.50mm Insulator is only available without locating peg.	140	02	10.70	1.27	2.54		with "locating pegs" (only available for dual row Pin Headers) C = Tube packing; w/o „PickUp Cap“ D = Tube packing; with „PickUp Cap“ E = Reel packing; with „PickUp Cap“
				03	14.20	0.64	2.54		
				04	6.00	0.64	2.54		
				05	10.70	1.82	2.54		
				06	6.00	1.27	2.54		
				07	4.00	1.00	1.50		
				08	9.60	1.90	2.54		
				09	8.13	1.27	2.54		
				10	3.00	1.96	2.54		
				11	8.10	0.72	2.54		
				12	3.23	3.22	2.54		
13	4.85	2.30	2.54						
				other dimensions on request					

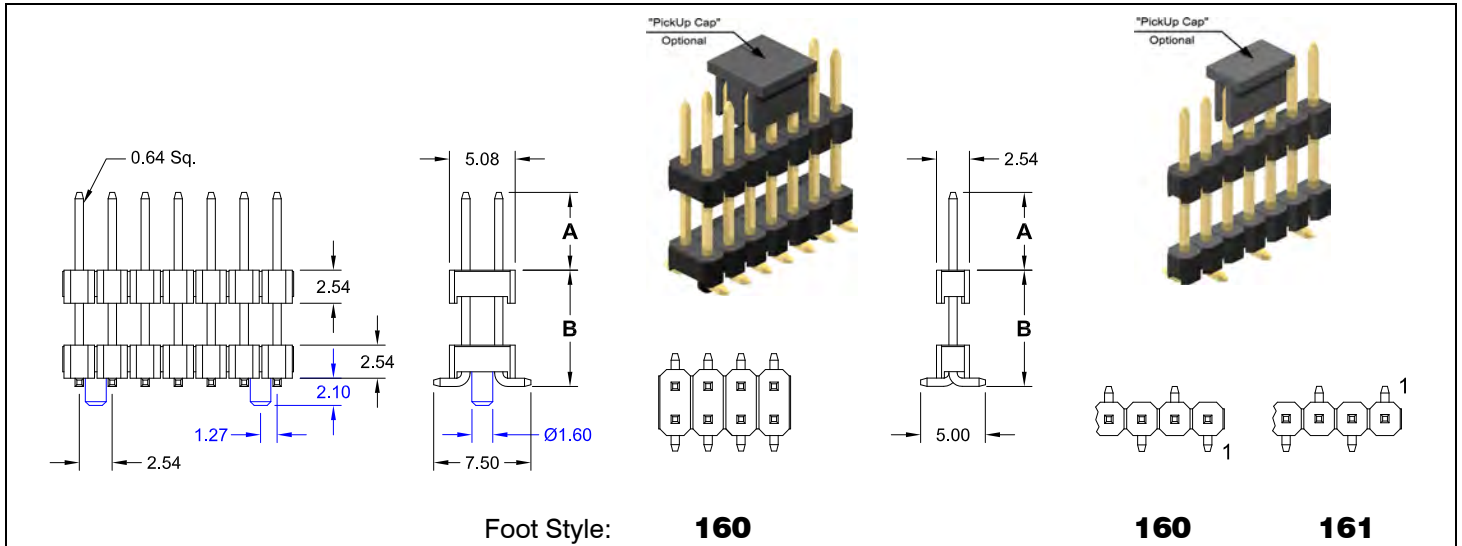

Foot Style: **160** **160** **161**

Application and Features

- **Standard: Tube packing, without "locating pegs" and without "PickUp Cap"**
- Designed for "Board to Board" spacing
- Variable terminal length available
- Mate with Female Header 2.54mm pitch

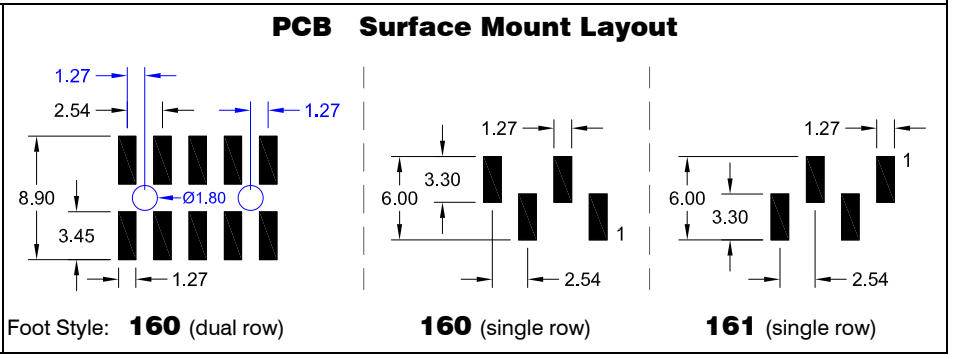

Specifications

Current rating	3 A	Operating temperature	- 40°C to +105°C
Insulation resistance	1000 MΩ min.	Processing temperature	+250°C +0/-5°C for 5sec.
Withstanding voltage	500 V AC	Contact material	(RoHS compliant) Copper alloy
		Insulator material	(RoHS compliant) PA6T UL 94 V-0

How to order

SP **X** - **xxx** - H **xxx** / **xx** - **55** X

Rows	Nbr of pins	Foot Style	Pin code	DIM "A"	DIM "B"	Plating	Options				
1 single row	002 to 040	160 161 Pls. choose 160 Style if odd pin count.	16	3,50 mm	5,30 mm	55 = Gold other platings on request	without "locating pegs" A = Tube packing; with „PickUp Cap“ B = Reel packing; with „PickUp Cap“				
			03	5,50 mm	6,40 mm						
			12	5,50 mm	7,50 mm						
			04	7,50 mm	9,40 mm						
			07	5,90 mm	10,60 mm						
			09	3,70 mm	10,70 mm						
			01	6,00 mm	11,40 mm						
			15	6,90 mm	12,50 mm						
			14	8,80 mm	13,60 mm						
			06	5,50 mm	14,00 mm						
			17	7,00 mm	14,50 mm						
2 dual row	004 to 080	160	05	6,00 mm	15,50 mm	other platings on request	with "locating pegs" dual row only! C = Tube packing; w/o „PickUp Cap“ D = Tube packing; with „PickUp Cap“ E = Reel packing; with „PickUp Cap“				
			13	8,80 mm	16,10 mm						
			02	4,50 mm	17,00 mm						
			08	6,00 mm	28,00 mm						
			10	2,70 mm	28,30 mm						
			11	4,00 mm	34,30 mm						
								other dimensions on request			

2.54mm pitch Pin Header - slanted -
- SMT - single and dual row

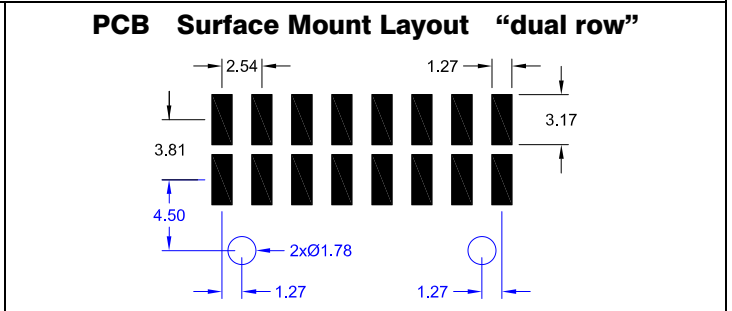
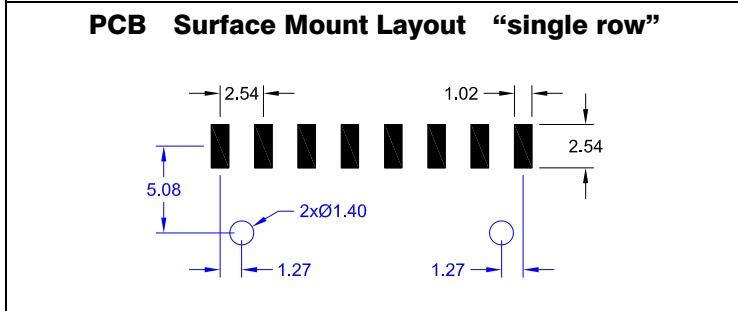
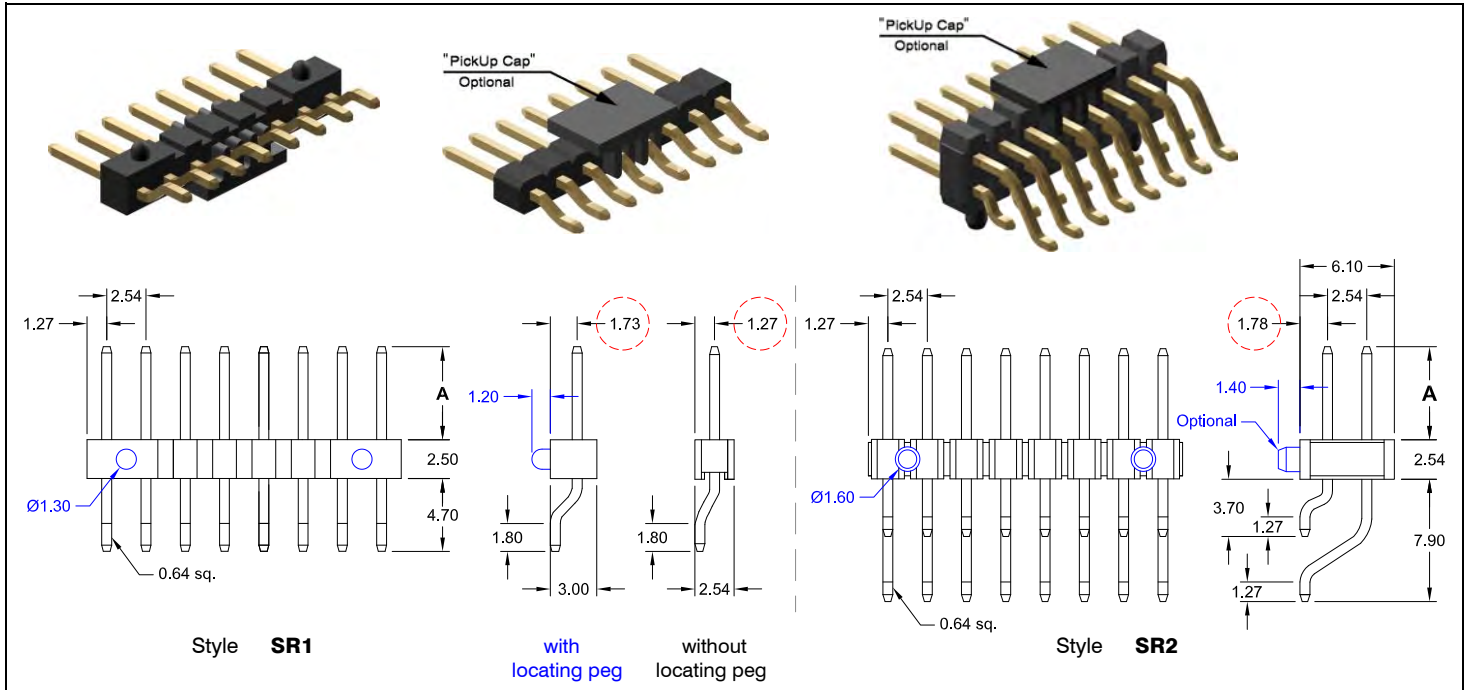

Specifications

Current rating	3 A
Insulation resistance	1000 MΩ min.
Withstanding voltage	500 V AC

Operating temperature	- 40°C to +105°C
Processing temperature	+250°C +5/-0°C for 5sec.
Contact material	(RoHS compliant) Copper alloy
Insulator material	(RoHS compliant) SR1 = PA6T UL 94 V-0 SR2 = LCP UL 94 V-0

How to order

SR **x** - **xxx** - H **xxx/xx** - **xx** **X**

Rows	Nbr of pins	Pin code	DIM "A"	Plating	Options (standard: Tube packing and w/o PickUp Cap)
1 single row	without locating pegs 002 to 040	135/00	3.00 mm	55 = Gold 95 = Tin/Gold <i>(tin leadfree)</i> other platings on request	without "locating pegs" A = Tube packing; with „PickUp Cap“ B = Reel packing; with „PickUp Cap“
	with locating pegs 003 to 030	135/01	3.60 mm		with "locating pegs" C = Tube packing; without „PickUp Cap“ D = Tube packing; with „PickUp Cap“ E = Reel packing; with „PickUp Cap“
2 dual row	006 to 080	135/02	6.00 mm		
		135/03	6.80 mm		
		135/04	7.20 mm		
		135/05	7.40 mm		
		135/06	10.70 mm		
		135/07	10.40 mm		
		135/08	5.85 mm		
		135/09	8.15 mm		
		135/10	10.00 mm		
		other dimensions on request			

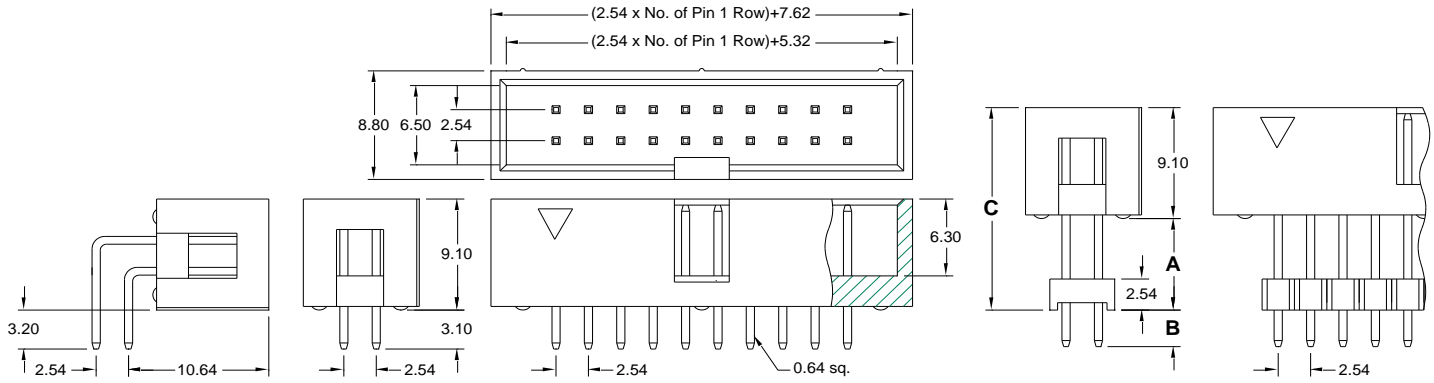
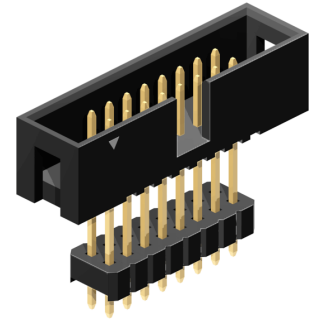
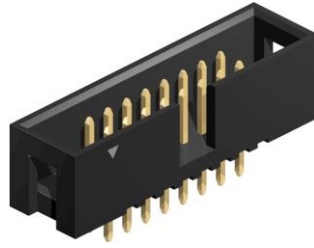
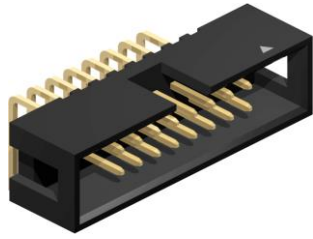

Style **R920**

S920

Dxxx

Application and Features

- Mating devices for Female Headers, solder tail and IDC Type
- Reliable flat cable to PCB connection
- No ejection latches for space saving

PCB Hole Layout

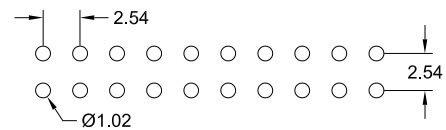

Specifications

Current rating	3 A	Operating temperature	- 40°C to +105°C
Insulation resistance	1000 MΩ min.	Contact material	Brass (RoHS compliant)
Withstanding voltage	500 V AC	Insulator material	PBT (RoHS compliant) UL 94 V-0

How to order

SLS - xxx - X xxx - 55

Nbr of pins	Style	Pin code for "Dxxx" = raised Style	DIM "A" (mm)	DIM "B" (mm)	DIM "C" (mm)	Plating
"S" & "R" Style: 006; 008; 010; 012; 014; 016 020; 024; 026; 030; 034; 040 044; 050; 060; 064	S920 = straight R920 = right angle	141 166 232 235	5.00 7.50 14.10 14.40	3.00 3.00 3.00 3.00	14.10 16.60 23.20 23.50	55 = Gold other platings on request
"D" Style: 006; 008; 010; 012; 014; 016 020; 024; 026; 030; 034; 040 050; 060; 064	Dxxx = raised Style	other dimensions on request				

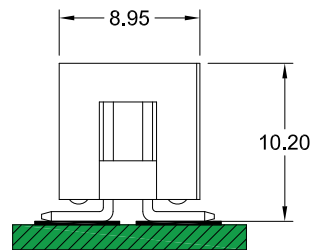
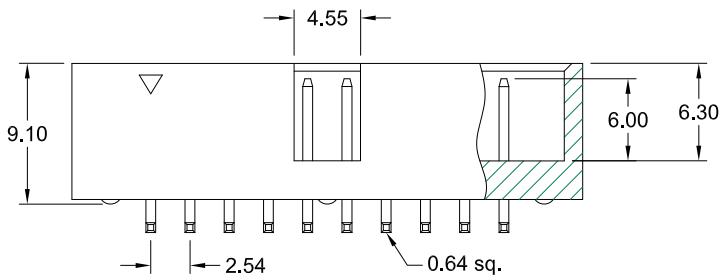
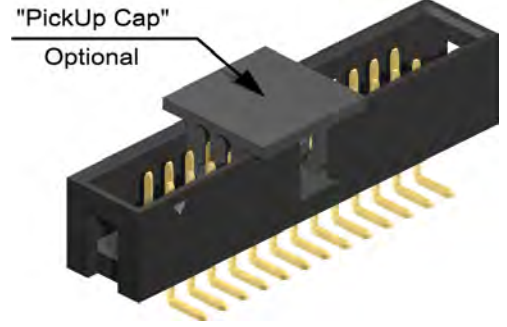
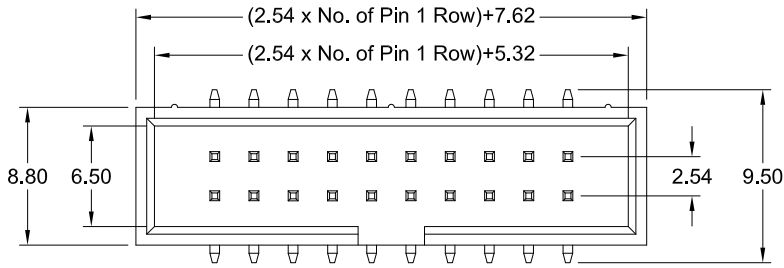

Application and Features

- **Standard: Tray packing and without "PickUp Cap"**
- Also available "Reel" packing
- Mating devices for Female Headers, solder tail and IDC Type
- Reliable flat cable to PCB connection
- No ejector latches for space saving

PCB Surface Mount Layout

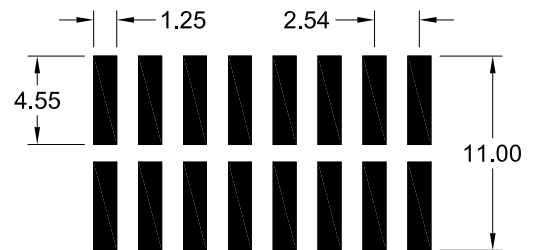

Specifications

Current rating	3 A
Insulation resistance	1000 MΩ min.
Withstanding voltage	500 V AC

Operating temperature	- 40°C to +105°C
Processing temperature	+250°C +0/-5°C for 5sec.
Contact material	(RoHS compliant) Brass
Insulator material	(RoHS compliant) PA6T UL 94 V-0

How to order

SLS - xxx - H885 - 55 / X

Nbr of pins
006; 008; 010; 012
014; 016; 020; 024
026; 030; 034; 040
044; 050

Plating
55 = Gold
other platings on request

Packing and „PickUp Cap“ Option
F = Tray packing; with „PickUp Cap“
T = Tube packing; without „PickUp Cap“
A = Tube packing; with „PickUp Cap“
B = Reel packing; with „PickUp Cap“

2.54mm pitch Box Header
 - THT - with metal ejection latches

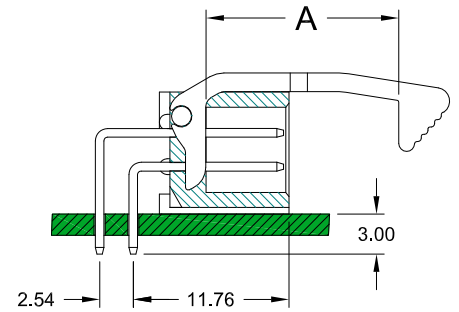
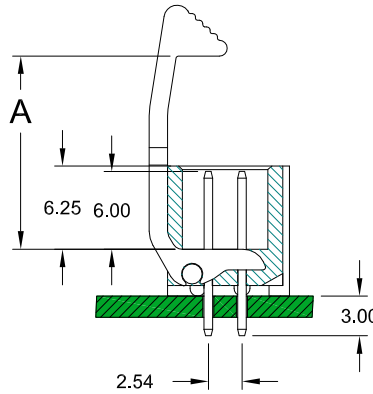
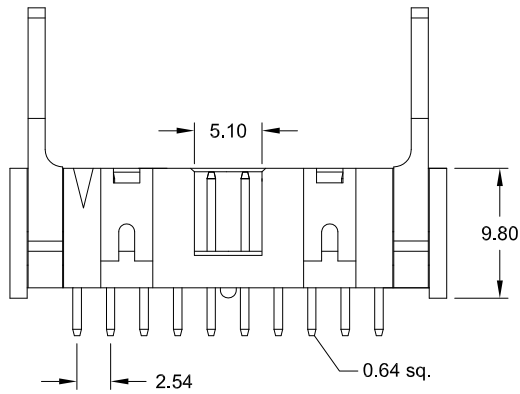
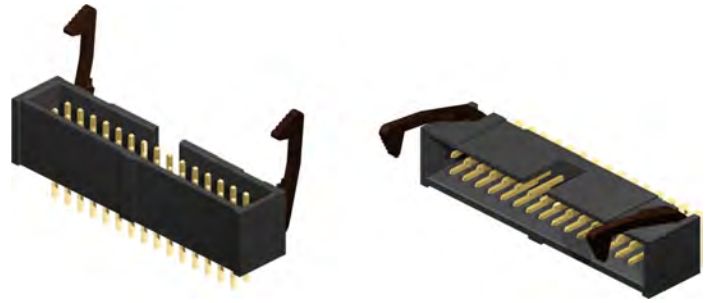
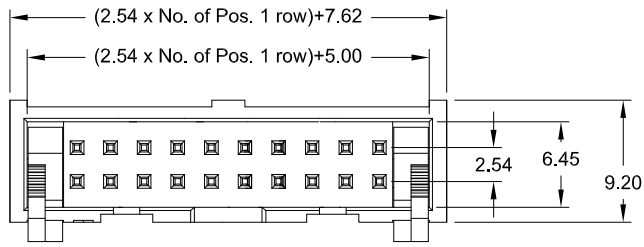

Style **S103**

R103

Application and Features

- Mating devices for Female Headers IDC Type
- Reliable flat cable to PCB connection
- Ejection latches for easy handling

PCB Hole Layout

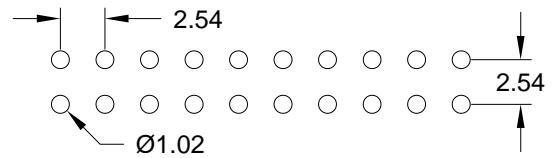

Specifications

Current rating	3 A
Insulation resistance	1000 MΩ min.
Withstanding voltage	1000 V AC

Operating temperature	- 40°C to +105°C
Contact material	(RoHS compliant) Copper alloy
Insulator material	(RoHS compliant) PBT UL 94 V-0
	Standard: black

How to order

SLS - xxx - X 103 - 55 / X

Nbr of pins
006; 008; 010
014; 016; 020
026; 030; 034
040; 050; 060
064

Style
S = straight
R = right angle

Plating
55 = Gold
other platings on request

Latch Style
S = short latch DIM "A" = 10.65 mm
L = long latch DIM "A" = 14.55 mm

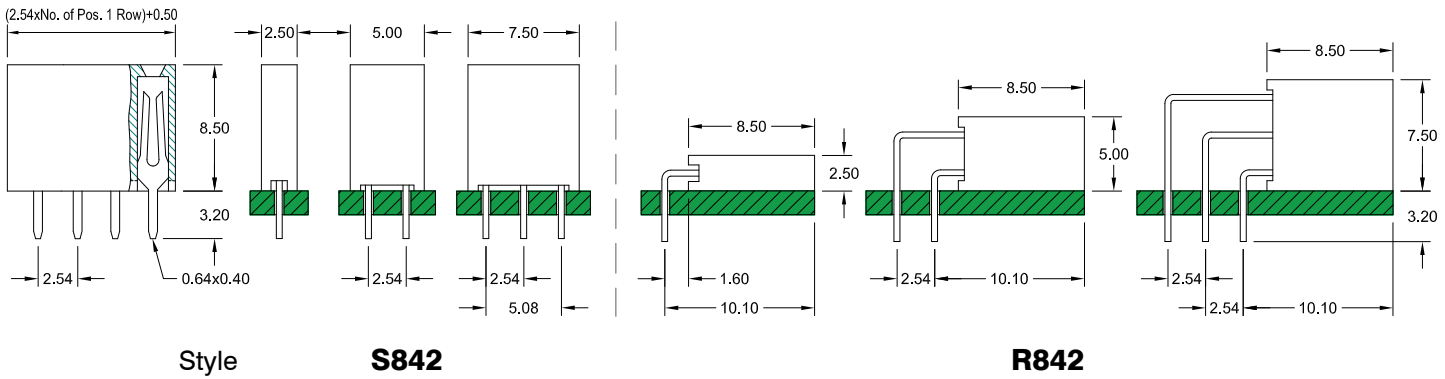
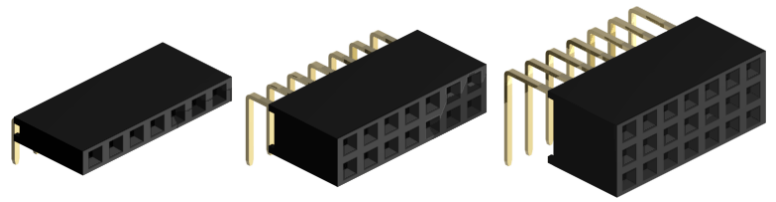
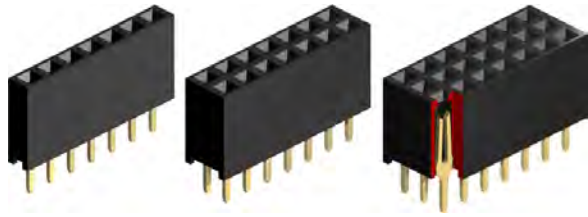

PCB Hole Layout

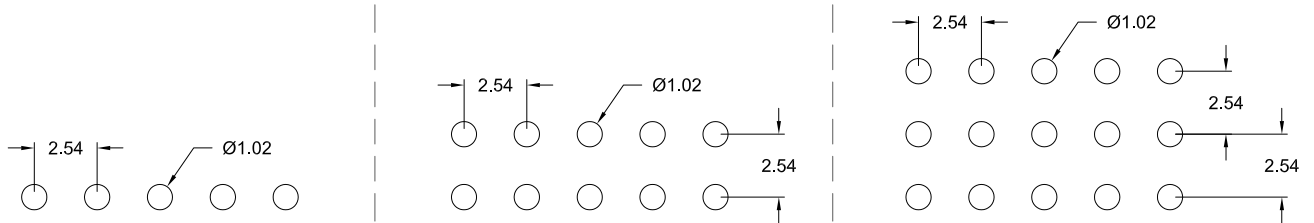

Application and Features

- Standard profile, 8.50 mm height for straight connector style
- Hi-rel fork contacts
- Accepts 0.64 mm square pins

Specification

Current rating	3 A
Insulation resistance	1000 MΩ min.
Contact resistance	20 mΩ max.
Withstanding voltage	500 V AC
Operating temperature	- 40°C to +105°C
Contact material <i>(RoHS compliant)</i>	Brass
Insulator material <i>(RoHS compliant)</i>	PBT UL 94 V-0

How to order

BL x - xxx - X842 - 55

Rows	Nbr of contacts	Connector Style	Plating
1 = single row 2 = dual row 3 = triple row	single row = 002 to 040 dual row = 004 to 080 triple row = 009 to 120	S842 = straight R842 = right angle dimensions see drawings above	55 = Gold other platings on request

2.45mm pitch Female Header
 - THT - 5.70mm profile

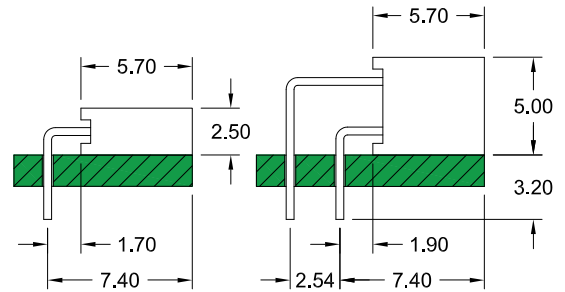
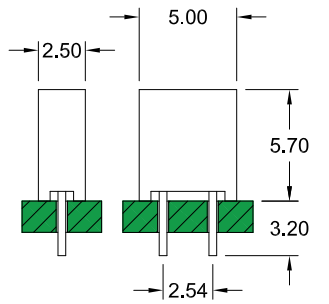
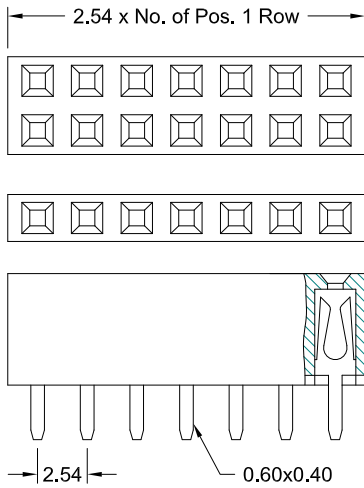
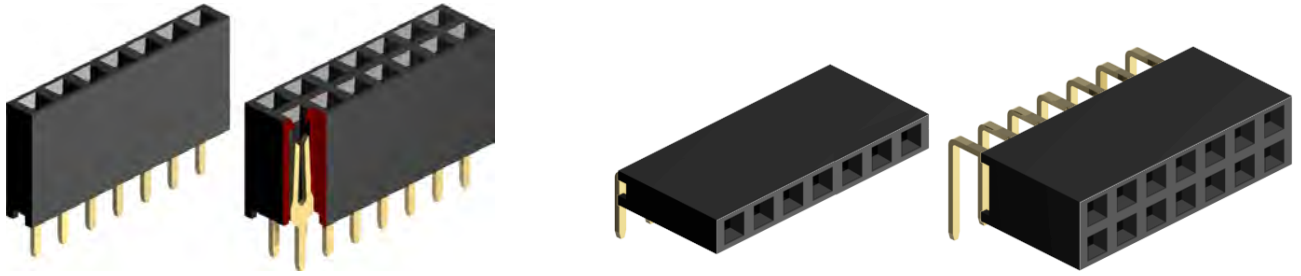

Style

S570

R570

Specifications

Current rating	3 A
Insulation resistance	1000 MΩ min.
Contact resistance	20 mΩ max.
Withstanding voltage	500 V AC
Operating temperature	- 40°C to +105°C
Contact material	(RoHS compliant) Phosphor Bronze
Insulator material	(RoHS compliant) PBT UL 94 V-0

PCB Hole Layout

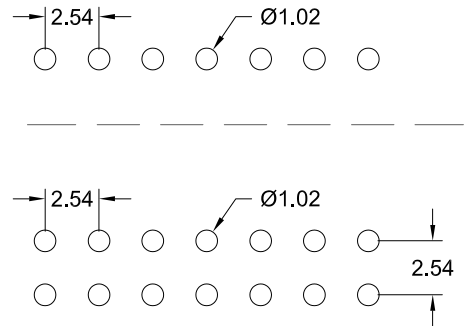

How to order

BL x - xxx - X 570 - 55

Rows	
1	= single row
2	= dual row

Nbr of contacts	
single row	= 002 to 040
dual row	= 004 to 080

Connector Style	
S	= straight
R	= right angle

Plating	
55	= Gold
other platings on request	

2.54mm pitch Female Header
- THT - folded contacts

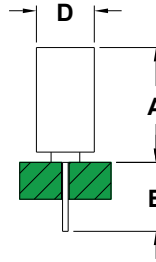
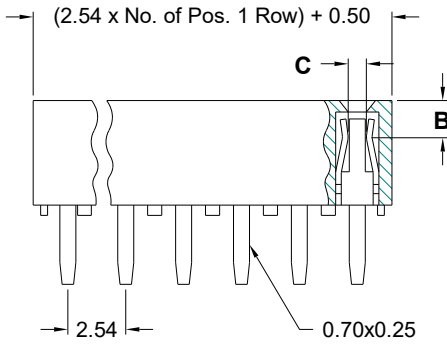
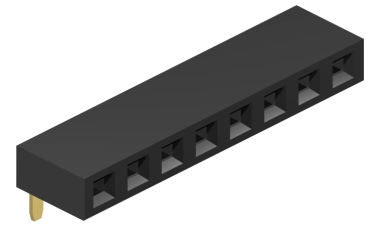
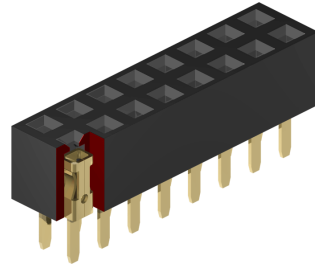
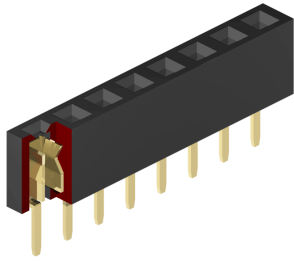

single row

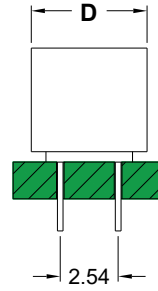

dual row

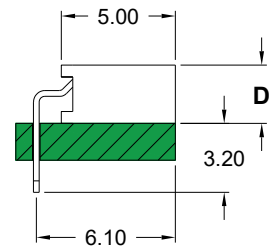

right angle

PCB Hole Layout

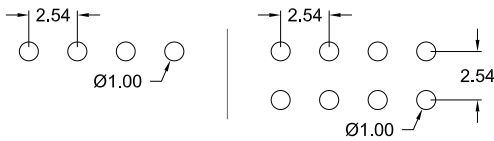

Specifications

Current rating	3 A
Insulation resistance	1000 MΩ min.
Contact resistance	20 mΩ max.
Withstanding voltage	500 V AC
Operating temperature	- 40°C to +105°C
Contact material	(RoHS compliant) Phosphor Bronze
Insulator material	(RoHS compliant) PBT UL 94 V-0

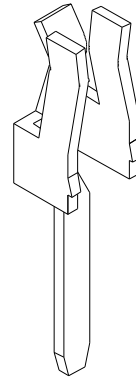

Contact Style 1

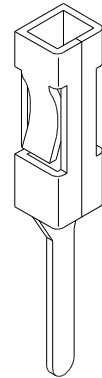

Contact Style 2

How to order

BF x - xxx - Xxxx - **55**

Rows	Nbr of contacts	Code	Connector Style	Contact Style	DIM "A" (mm)	DIM "B" (mm)	DIM "C" (mm)	DIM "D" (mm)	DIM "E" (mm)	Plating
1 = 1 row 2 = 2 rows	002 to 040 (1 row) 004 to 080 (2 rows)	S500	straight	1	5.00	1.50	0.42	2.50 (1 row) 5.00 (2 rows)	3.20	55 = Gold other platings on request
1 = 1 row	002 to 040 (1 row)	R500	R/A	1		1.50	0.42	2.50 (1 row)	3.20	
1 = 1 row 2 = 2 rows	002 to 030 (1 row) 004 to 060 (2 rows)	S680	straight	2	6.80	3.50	0.50	3.50 (1 row) 5.80 (2 rows)	3.50	
1 = 1 row 2 = 2 rows	002 to 040 (1 row) 004 to 080 (2 rows)	S710	straight	1	7.10	1.50	0.25	2.50 (1 row) 5.00 (2 rows)	3.20	
1 = 1 row 2 = 2 rows	002 to 040 (1 row) 004 to 080 (2 rows)	S850	straight	1	8.50	1.50	0.25	3.00 (1 row) 5.50 (2 rows)	3.20	

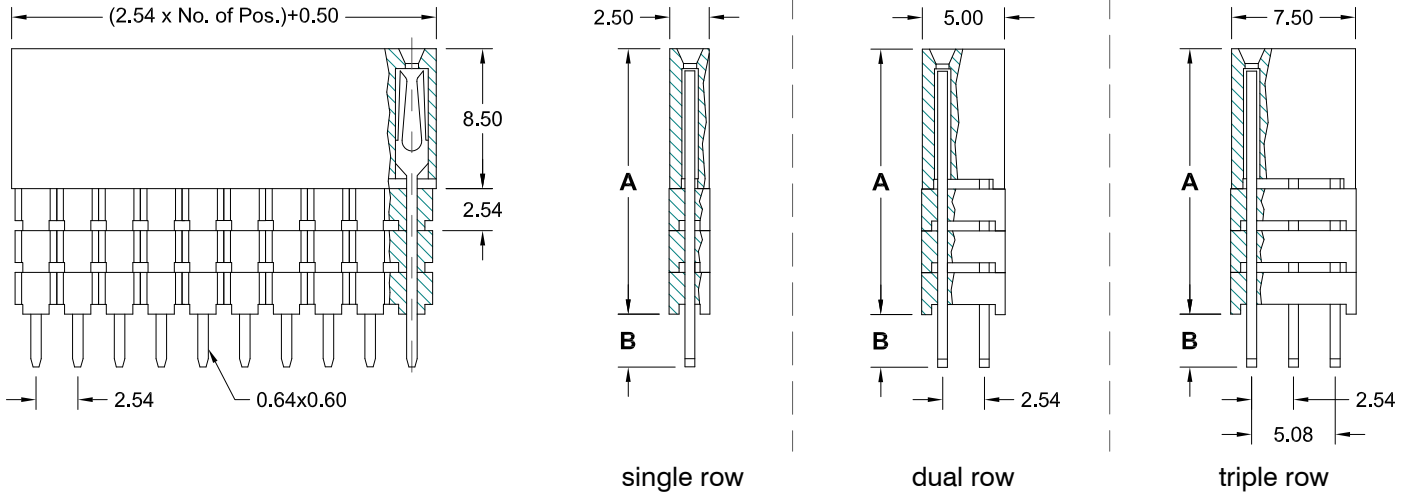
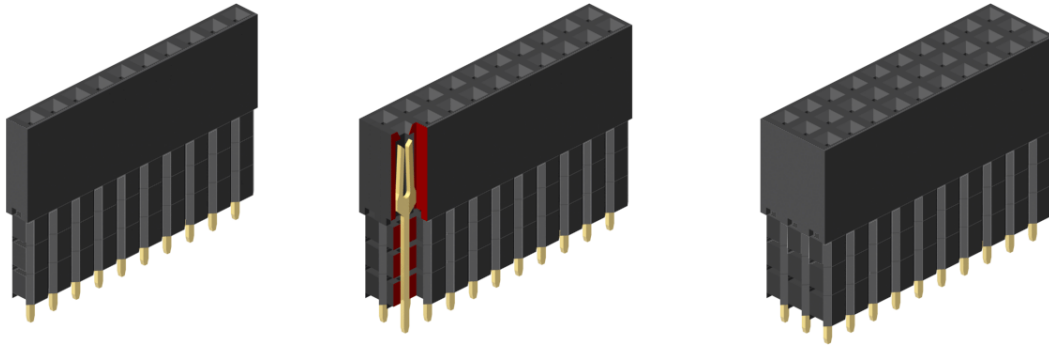

Application and Features

- Various heights for Board-to-Board connections
- Ideal solution for PC/104-Plus Systems
- Accepts 0.64mm square pins
- Hi-rel fork contact design

PCB Hole Layout

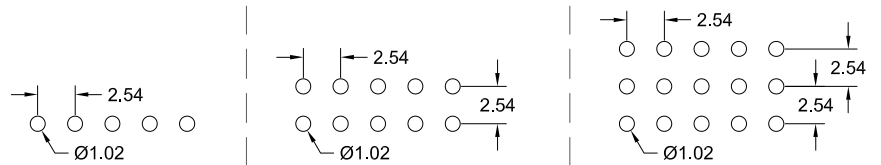

Specifications

Current rating	3 A	Operating temperature	- 40°C to +105°C
Insulation resistance	1000 MΩ min.	Contact material	Phosphor Bronze
Contact resistance	20 mΩ max.	Insulator material	PBT UL 94 V-0
Withstanding voltage	500 V AC		

How to order

BE x - **xxx** - **S** xxx - **55**

Rows	Nbr of contacts	Style	DIM "A"	DIM "B"	Plating
1 = single row	single row = 002 to 040	111	11.05 mm	2.30 mm	55 = Gold
2 = dual row	dual row = 004 to 080	112	11.05 mm	7.35 mm	
3 = triple row	triple row = 006 to 120	113	11.05 mm	12.20 mm	other platings on request
		131	13.59 mm	4.85 mm	
132	13.59 mm	9.65 mm			
161	16.13 mm	2.30 mm			
162	16.13 mm	7.10 mm			
181	18.67 mm	4.60 mm			
other dimensions on request					

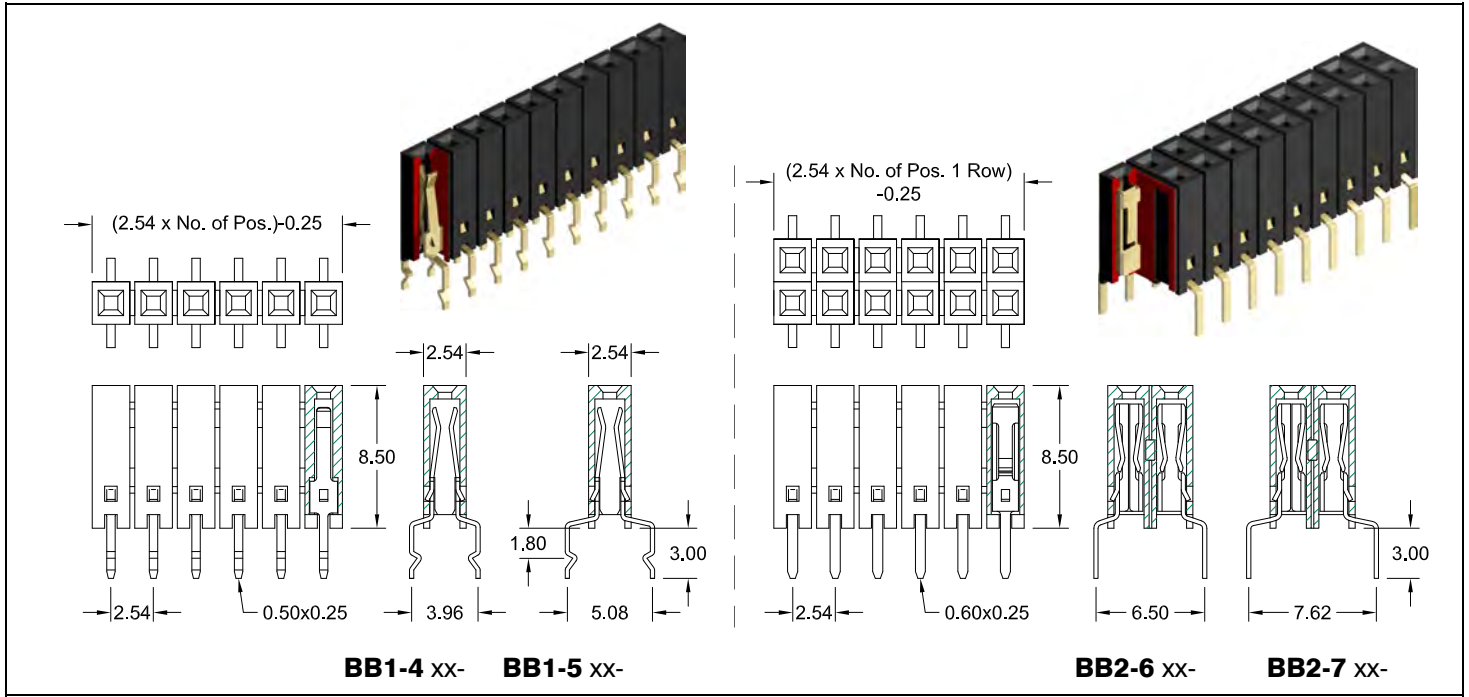

PCB Hole Layout

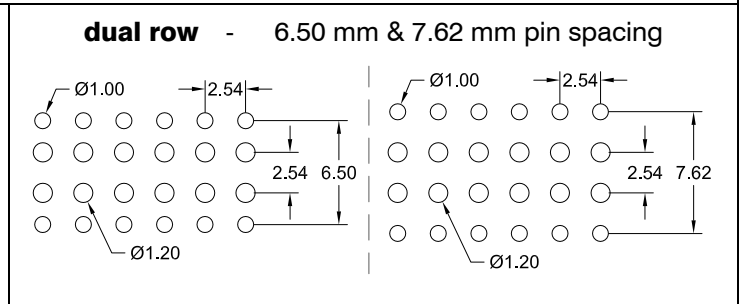
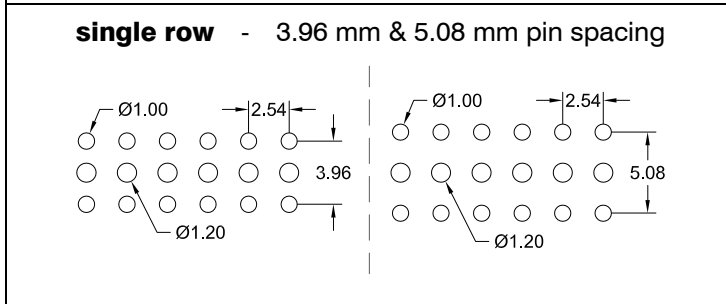

- Application and Features**
- Hi-rel dual beam contact assures reliable PCB connections
 - Dual entry design for board stacking
 - Accepts 0.64mm square pins
 - Stand-off's facilitate post solder cleaning

Specifications

Current rating	3 A
Insulation resistance	1000 MΩ min.
Contact resistance	20 mΩ max.
Withstanding voltage	500 V AC
Operating temperature	- 40°C to +105°C
Contact material	(RoHS compliant) Phosphor Bronze
Insulator material	(RoHS compliant) LCP UL 94 V-0

How to order

BB x - x xx - B850 - 55

Rows	
1	= single row
2	= dual row

Pin spacing	
4	= 3.96 mm
5	= 5.08 mm
6	= 6.50 mm
7	= 7.62 mm

Nbr of contacts	
single row	= 02 to 40
dual row	= 04 to 80

Plating	
55	= Gold

2.54mm pitch Female Header
 - THT - dual entry type low profile

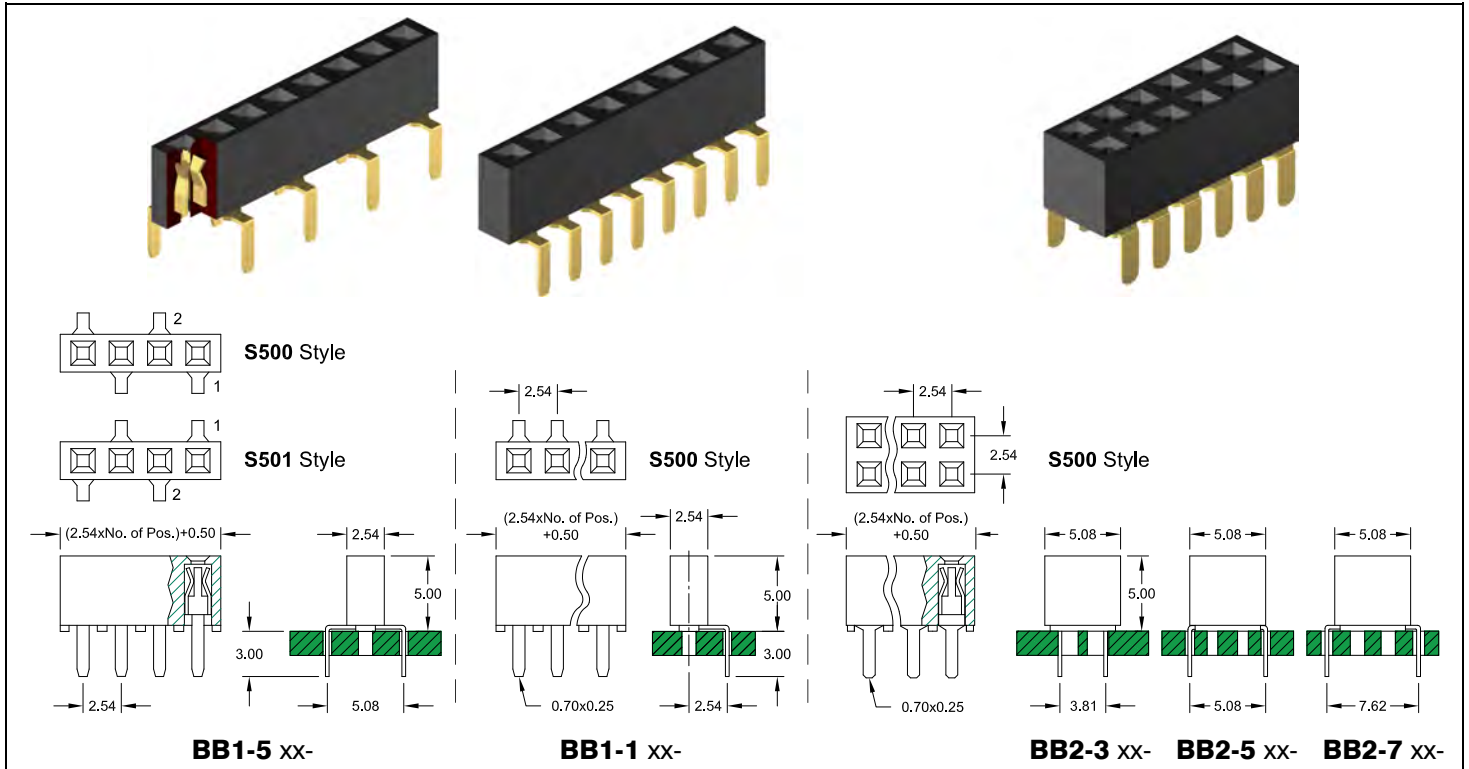

PCB Hole Layout

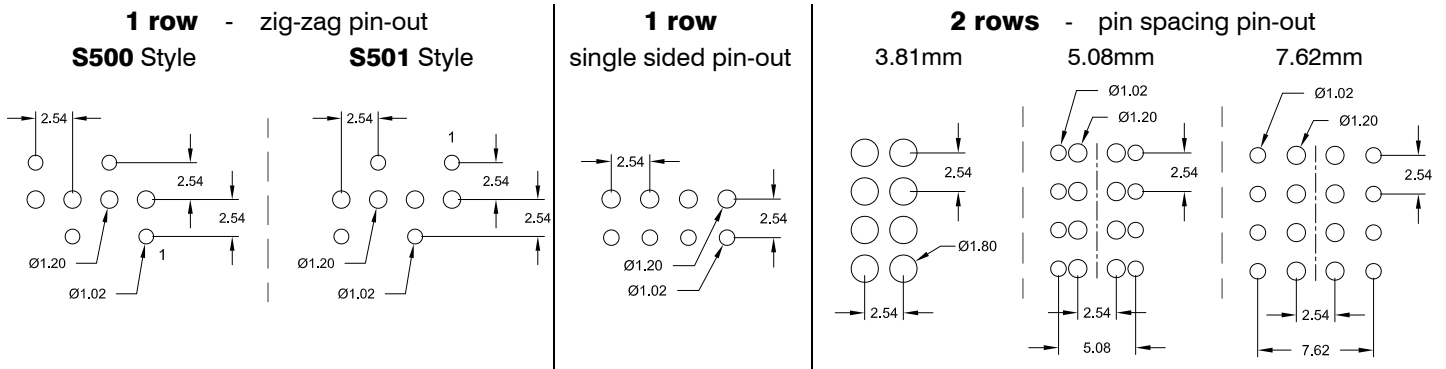

Application and Features

- Hi-rel dual beam contact assures reliable PCB connections
- Dual entry design for board stacking
- Accepts 0.64mm square pins
- Stand-off's facilitate post solder cleaning

Specifications

Current rating	3 A
Insulation resistance	1000 MΩ min.
Contact resistance	20 mΩ max.
Withstanding voltage	500 V AC
Operating temperature	- 40°C to +105°C
Contact material (RoHS compliant)	Phosphor Bronze
Insulator material (RoHS compliant)	PBT UL 94 V-0

How to order

BB x - x xx - S xxx - 55

Rows	Pin spacing	Nbr of contacts	Foot Style	Plating
1 = single row	1 = single side only 5 = 5.08mm zig-zag	<i>single row</i> 02 to 40	<i>single row</i> 500 & 501 Pls. choose 500 Style if odd pin count.	55 = Gold
2 = dual row	3 = 3.81 mm 5 = 5.08 mm 7 = 7.62 mm	<i>dual row</i> 04 to 80	<i>dual row</i> 500	other platings on request

2.54mm pitch Female Header
 - THT - for "Box Header" mating

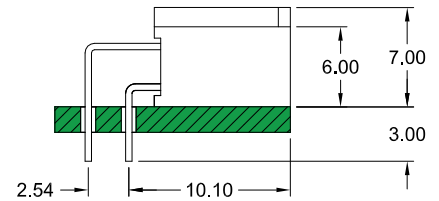
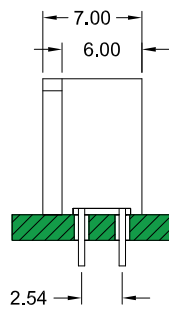
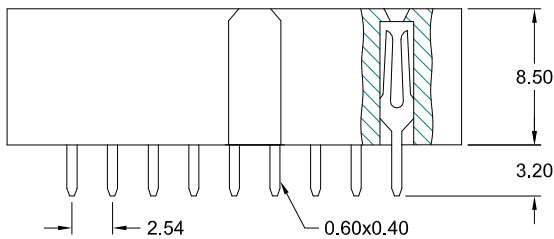
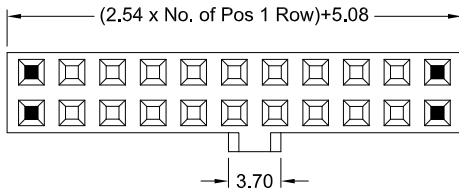
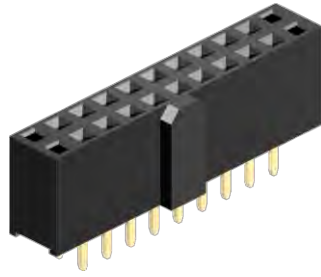

Application and Features

Mating with Box (Shrouded) Header 2.54mm pitch

SLS-xxx-S920-xx, SLS-xxx-R920-xx, SLS-xxx-Dxxx-xx & SLS-xxx-H885-xx/X

Standard with polarization bump.

Specifications

Current rating	3 A
Insulation resistance	1000 MΩ min.
Contact resistance	20 mΩ max.
Withstanding voltage	500 V AC
Operating temperature	- 40°C to + 105°C
Contact material	(RoHS compliant) Phosphor Bronze
Insulator Material	(RoHS compliant) PBT UL 94 V-0

PCB Hole Layout

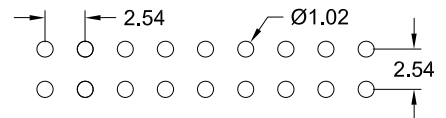

How to order

BW2 - xxx - X 850 - 55/P

Nbr of contacts
006; 008; 010; 014
016; 020; 024; 026
030; 034; 040; 044
048; 050; 060; 064

Connector Style
S = straight
R = right angle

Plating
55 = Gold
other platings on request

2.54mm pitch Female Header
- THT - side entry type

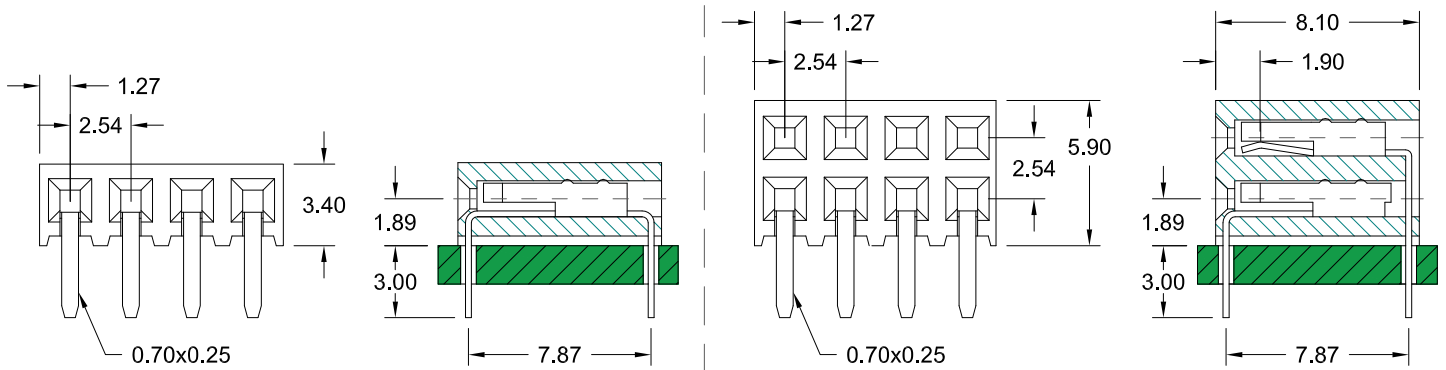
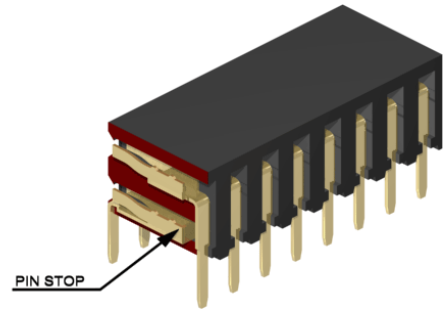
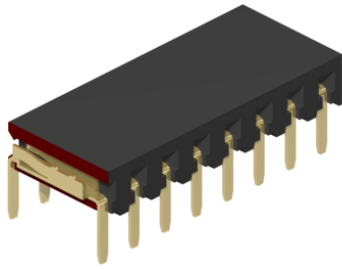

Application and Features

- **Standard: Tube packing**
- Hi-rel dual beam contact with "Pin Stop" assures reliable connections
- Accepts 0.64 mm square pins; Pin Header 2.54 mm x 2.54 mm
- 3.40 mm & 5.90 mm height above board
- Stand-off's facilitate post solder cleaning

PCB Hole Layout

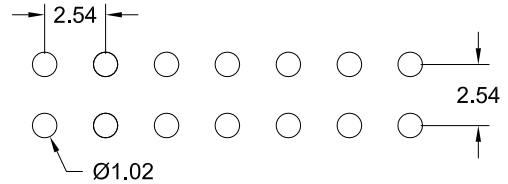

Specifications

Current rating	3 A
Insulation resistance	1000 MΩ min.
Contact resistance	20 mΩ max.
Withstanding voltage	500 V AC

Operating temperature	- 40°C to + 105°C
Contact material	(RoHS compliant) Phosphor Bronze
Insulator material	(RoHS compliant) PBT UL 94 V-0

How to order

BH x - xxx - R850 - 55

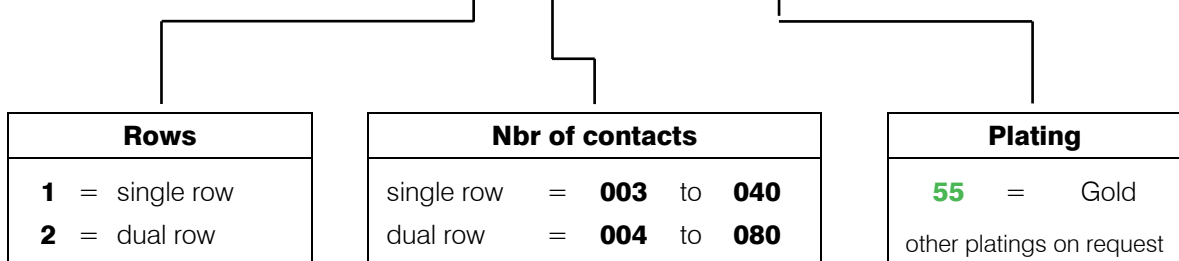

2.54mm pitch Female Header - SMT - Top & Bottom Entry 7.50mm & 5.00mm profile

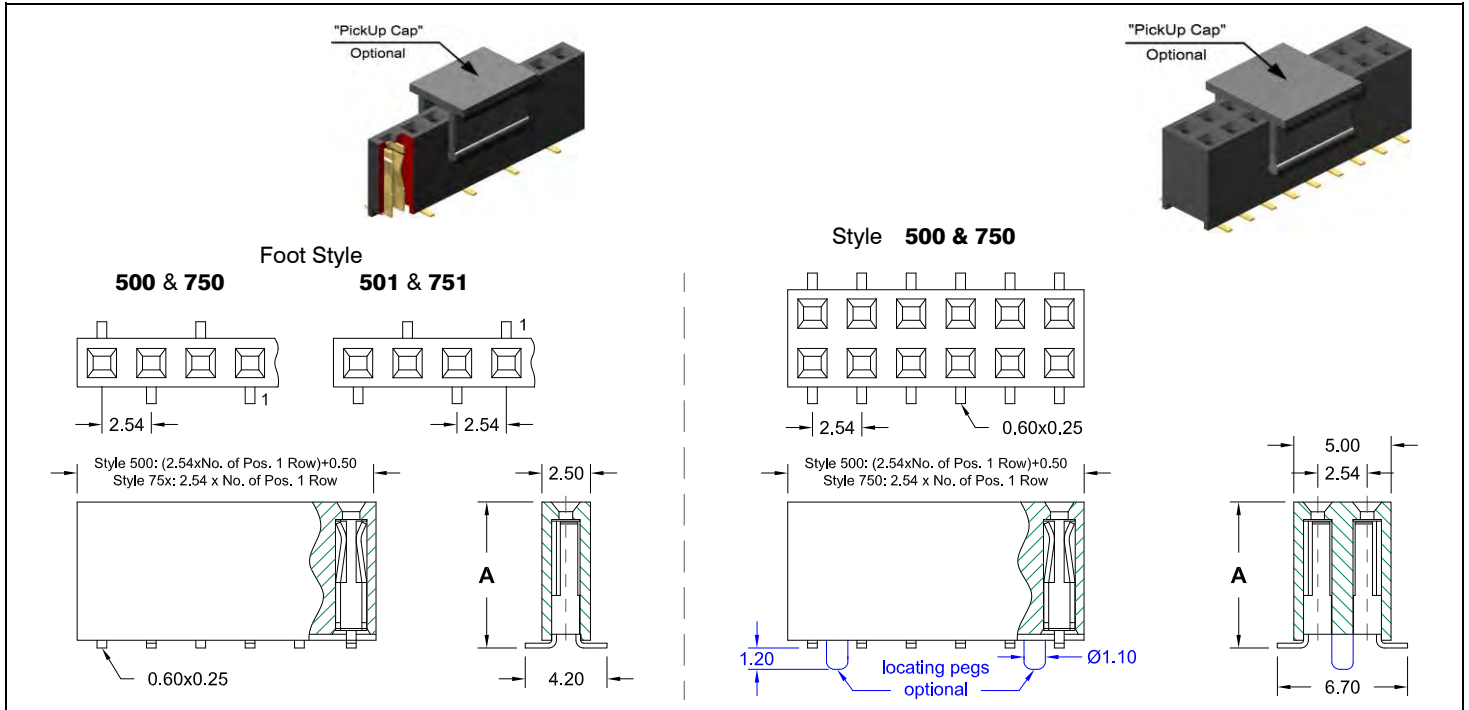

Application and Features

- **Standard: Tube packing and without "PickUp cap"**
- 5.00mm & 7.50mm height above board. Hi-rel dual beam contacts.
- Mating with 2.54mm pitch, 0.64mm sq. or round Pin Headers.

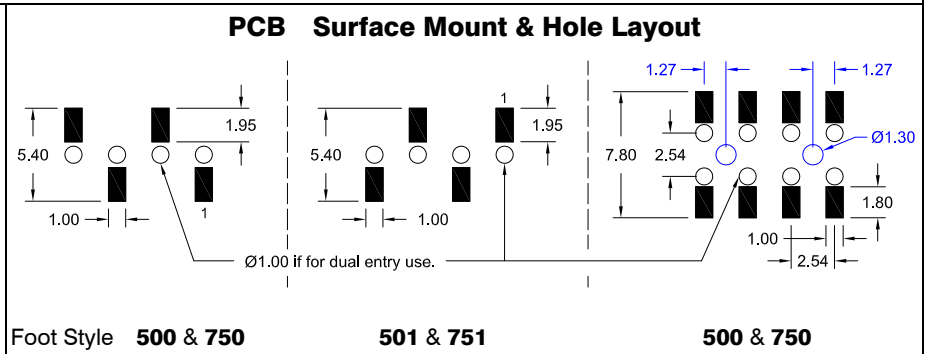

Specifications

Current rating	3 A	Operating temperature	-40° C to +105°C
Insulation resistance	1000 MΩ min.	Processing temperature	+250°C +0/-5°C for 5sec.
Contact resistance	20 mΩ max.	Contact material	Phosphor Bronze (RoHS compliant)
Withstanding voltage	500 V AC	Insulator material	PA6T UL 94 V-0 (RoHS compliant)

How to order

BS x - xxx - H xxx - 55/ X

Rows	Nbr of contacts	Style	Plating	Options
1 single row	002 to 040	500 DIM "A" = 5.00 mm	55 = Gold other platings on request	A = Tube packing; with „PickUp Cap“ B = Reel packing; with „PickUp Cap“ <hr/> without "locating pegs" A = Tube packing; with „PickUp Cap“ B = Reel packing; with „PickUp Cap“ <hr/> with "locating pegs" C = Tube packing; without „PickUp Cap“ D = Tube packing; with „PickUp Cap“ E = Reel packing; with „PickUp Cap“
		501 (optional foot Style)		
2 dual row	004 to 080	750 DIM "A" = 7.50 mm		
		751 (optional foot Style) Pls. choose 500 or 750 Style if odd pin count		

2.54mm pitch Female Header - SMT -
Top & Bottom Entry 3.65mm profile

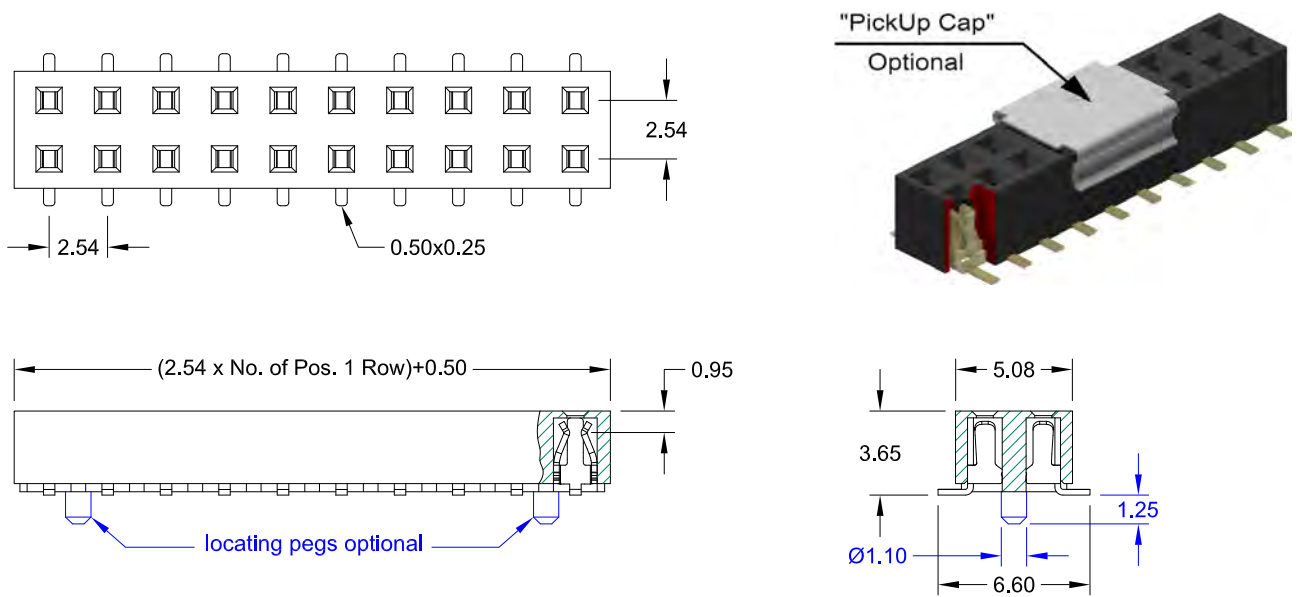

Application and Features

- **Standard:**
Tube packing and without "PickUp Cap"
- 3.65mm height above board.
- Hi-rel dual beam contacts
- Designed for board to board small spacing interconnection
- Mating with 2.54mm pitch, 0.64mm square Pin Headers

PCB Surface Mount & Hole Layout

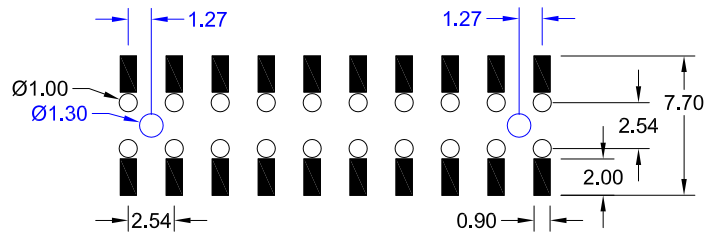

Specifications

Current rating	3 A	Operating temperature	- 40°C to +105°C
Insulation resistance	1000 MΩ min.	Processing temperature	+250°C +0/-5°C for 5sec.
Contact resistance	20 mΩ max.	Contact material	(RoHS compliant) Phosphor Bronze
Withstanding voltage	500 V AC	Insulator material	(RoHS compliant) PA6T UL 94 V-0

How to order

BS2 - xxx - TB365 - 55/ X

Nbr of contacts
004 to 080

Plating
55 = Gold
other platings on request

Options
without "locating pegs"
A = Tube packing; with „PickUp Cap“
B = Reel packing; with „PickUp Cap“
with "locating pegs" (available only from 006 to 080 contacts)
C = Tube packing; without „PickUp Cap“
D = Tube packing; with „PickUp Cap“
E = Reel packing; with „PickUp Cap“

When using this female connector as a bottom entry connector, we recommend that the Pin Header pins protrude by around 2.00mm above the surface of the female connector after assembly. This will avoid any risk of separation of the Pin Header from the Female Header during shock and vibration.

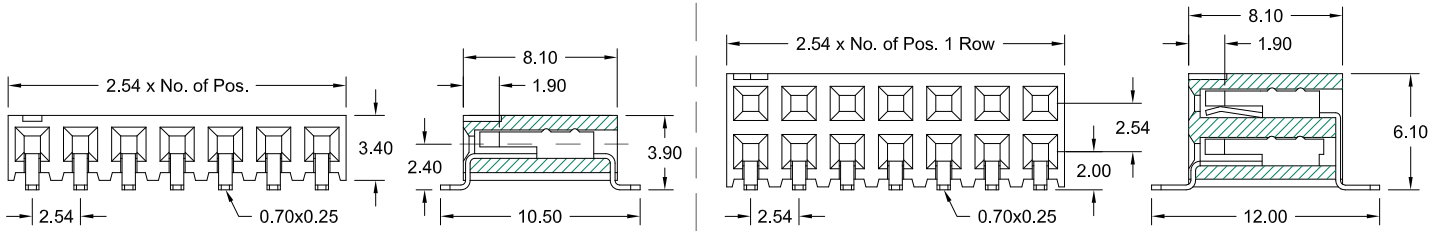
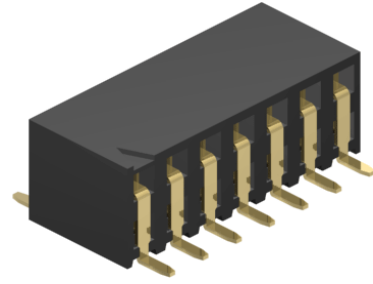
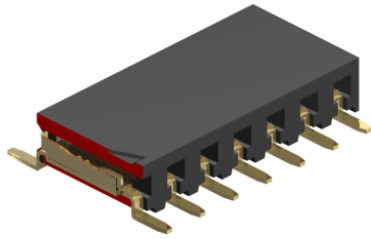

PCB Surface Mount Layout -single row-

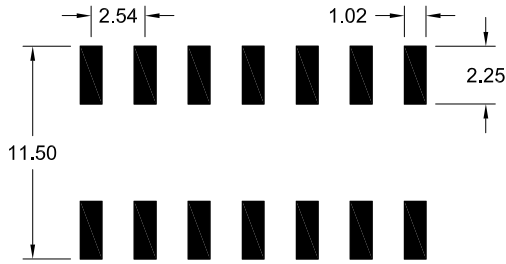

PCB Surface Mount Layout -dual row-

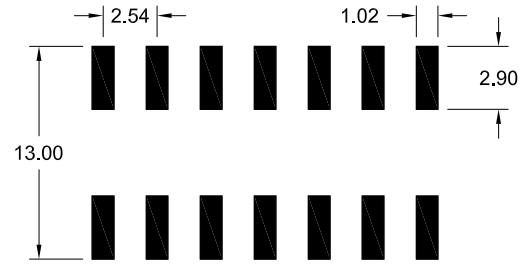

Application and Features

- **Standard: Tube packing**
- Hi-rel dual beam contact assures reliable PC-board connections
- Accepts 0.64mm square pins
- Stand-off's facilitate post solder cleaning
- Lowest possible profile
- Automatic assembly to PCB possible

Specifications

Current rating	3 A	Operating temperature	- 40°C to +105°C
Insulation resistance	1000 MΩ min.	Processing temperature	+250°C +/-5°C for 5sec.
Contact resistance	20 mΩ max.	Contact material (RoHS compliant)	Phosphor Bronze
Withstanding voltage	500 V AC	Insulator material (RoHS compliant)	PA6T UL 94 V-0

How to order

BS x - xxx - R390 - 55 /X

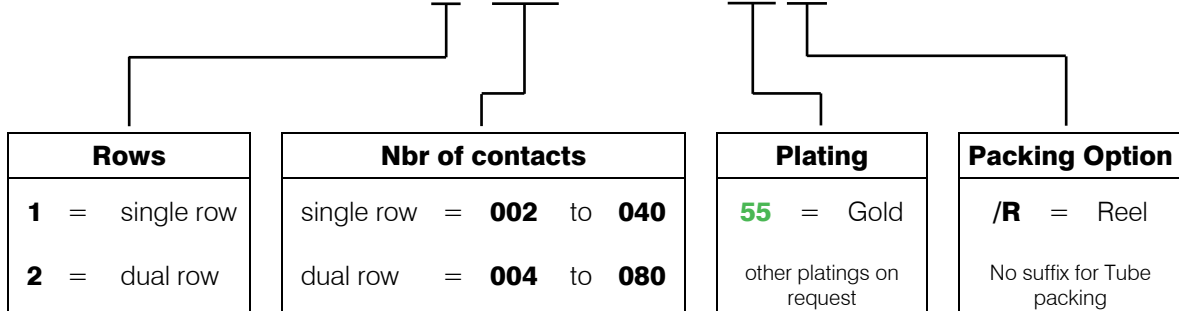

2.54mm pitch

IDC – Female Connector

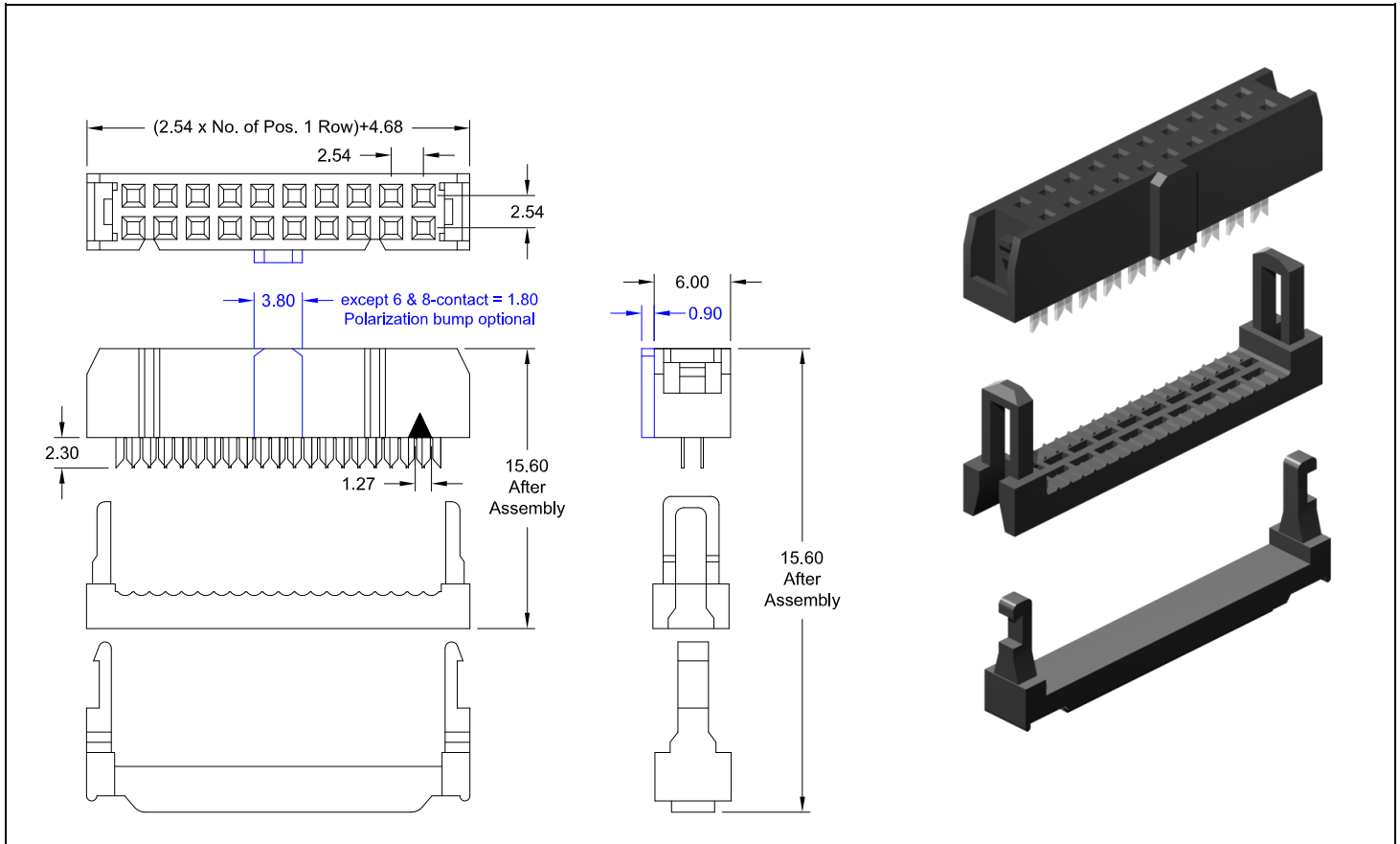

Specifications

Current rating	1 A	Operating temperature	- 40°C to +105°C
Insulation resistance	1000 MΩ min.	Contact material (RoHS compliant)	Brass
Contact resistance	30 mΩ max.	Plating	Nickel, Gold on mating area
Withstanding voltage	500 V AC	Insulator material (RoHS compliant)	PBT black UL 94 V-0 (grey colour on request)

Application and Features

Designed to mate with 0.64mm square pins Box (Shrouded) Header

High Quality contacts

Accepts 1.27mm pitch flat ribbon cable AWG 28 (0.20mm) or AWG 30 (0.17mm).

How to order

IDS - xxx - X 100 - N5 /P

Nbr of contacts
006; 008; 010; 012 014; 016; 018; 020 024; 026; 030; 034 036; 040; 050; 060 064

Strain relief
S = with
W = without

Option
/P
if Polarization bump is requested

2.54mm pitch

- THT - DIN Header (DIN 41651)

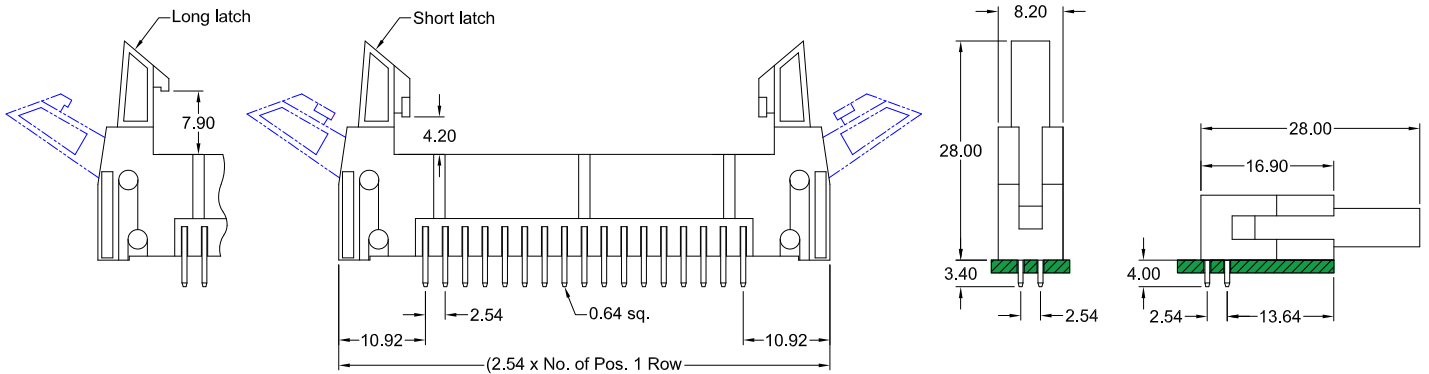
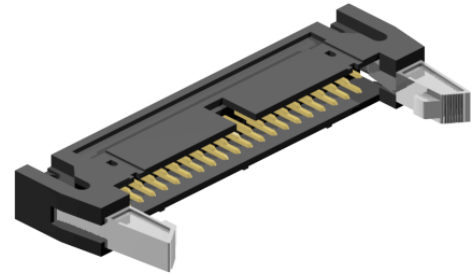
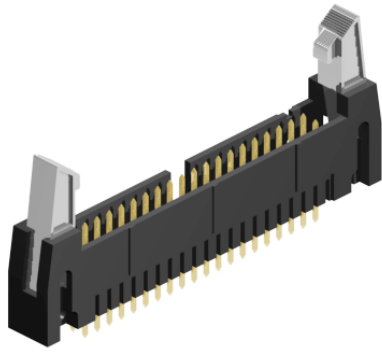

Application and Features

- Provides fast connection / disconnection of IDC connectors.
- Assures reliable flat cable to PC - board assembly.
- Optional latching features available.
- SMT & Press-Fit Type available on request.

PCB Hole Layout

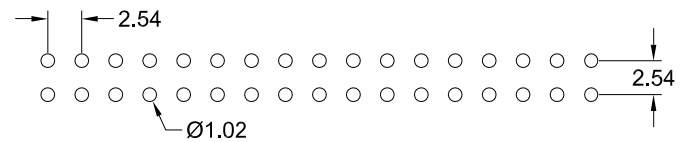

Specifications

Current rating	3 A
Insulation resistance	1000 MΩ min.
Withstanding voltage	500 V AC

Operating temperature	- 40°C to +105°C
Contact material	(RoHS compliant) Brass
Insulator material	(RoHS compliant) PBT UL 94 V-0 black colour

How to order

DH X - xxx - X 100 - 55

Latch type	Nbr of pins	Connector Style	Plating
S = short L = long W = without	010; 012; 014; 016 020; 024; 026; 030 034; 040; 050; 060 064	S = straight R = right angle SMT Style available on request	55 = Gold other platings on request

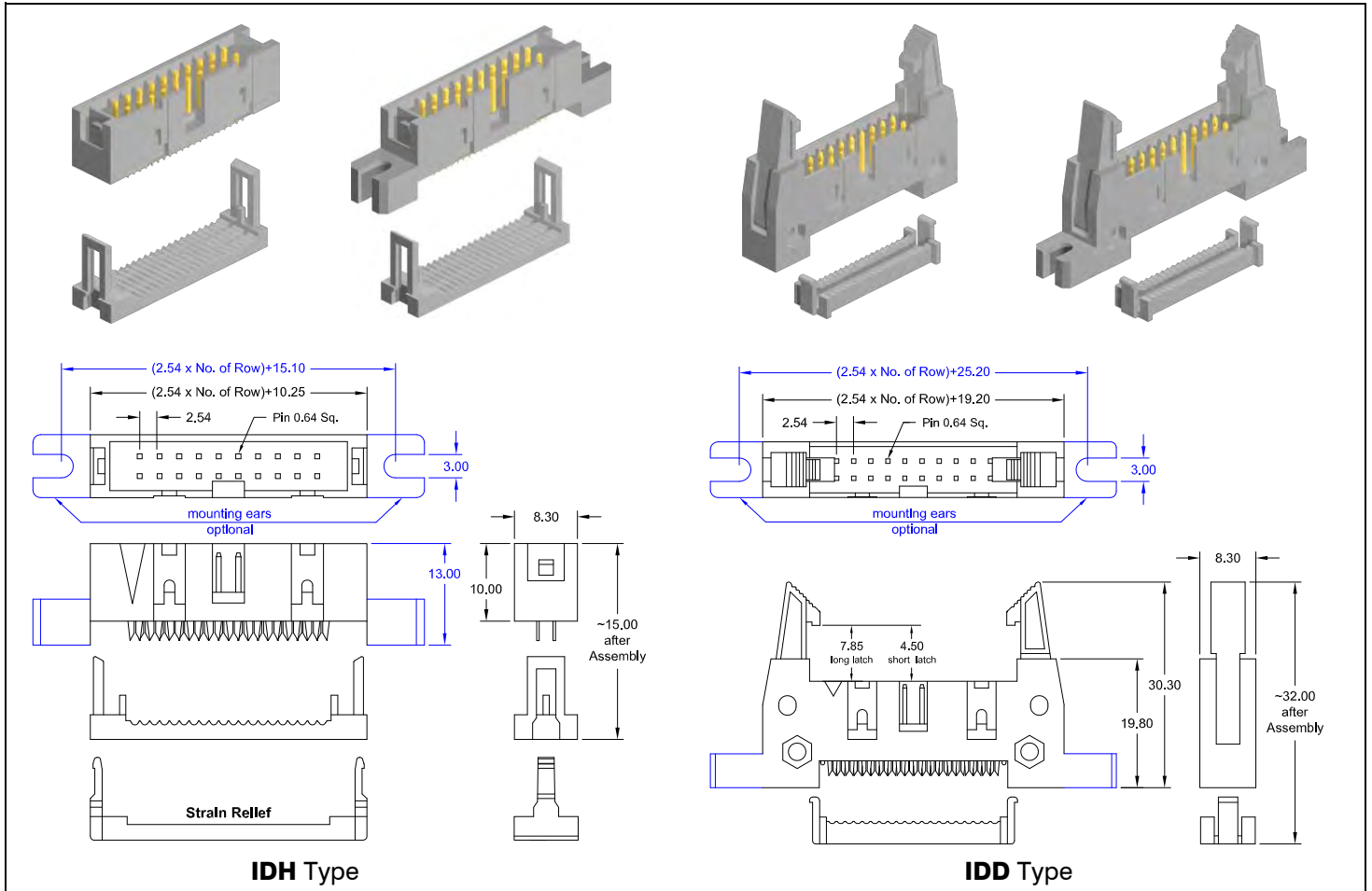

Specifications

Current rating	3 A	Operating temperature	- 40°C to +105°C
Insulation resistance	1000 MΩ min.	Contact material	(RoHS compliant) Brass
Withstanding voltage	1000 V AC	Insulator material	(RoHS compliant) PBT (grey) UL 94 V-0

Application and Features

Designed to mate with 2.54mm IDC Female Headers. Header type is available with or without mounting ears.
 DIN Header type IDD is available with long & short eject latches.
 Standard Insulator colour grey, other colours on request

How to order

ID X - xxx - X 100 - N5

Types	Nbr of pins	Executions	Plating
H = Header	010; 014; 016; 020 024; 026; 030; 034 040; 050; 060; 064 <i>available with strain relief:</i> 010; 014; 016; 020 026; 034; 040	IDH W = w/o ears WS = w/o ears, with strain relief E = with ears ES = with ears, with strain relief	N5 = Nickel/Gold other platings on request
D = DIN Header (DIN 41 651)	010; 014; 016; 020 024; 026; 030; 034 040; 050; 060; 064	IDD L = long latch, w/o ears LE = long latch, with ears S = short latch, w/o ears SE = short latch, with ears	

Mini – Jumpers

1.27mm, 2.00mm, 2.54mm & 5.08mm

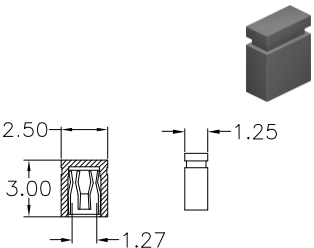
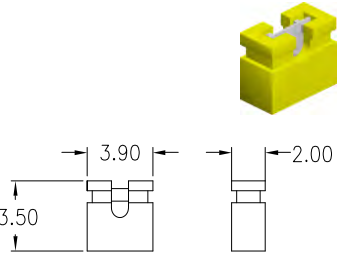
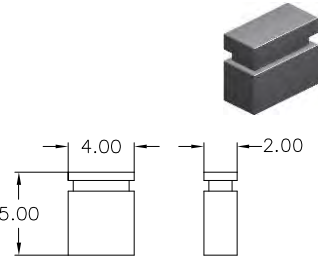
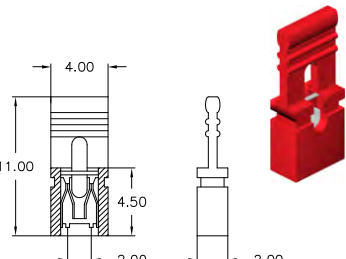

1.27mm & 2.00 mm Mini - Jumpers

<p>JPC – type - top closed -</p>  <p>Order Code: JPC – 127 – BL – 55</p>	<p>JPE – type - top open -</p>  <p>Order Code: JPE – 200 – BL – 55 Other colours: RD, BU, YL</p>	<p>JPC – type - top closed -</p>  <p>Order Code: JPC – 200 – BL – 55</p>	<p>JPH – type - with handle -</p>  <p>Order Code: JPH – 200 – BL – 55 Other colours: RD, BU, YL & WH</p>
--	--	--	--

2.54 mm & 5.08 mm Mini - Jumpers

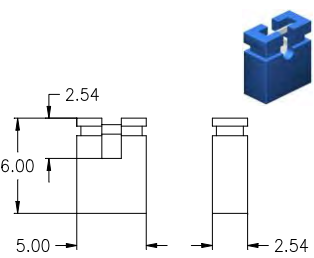
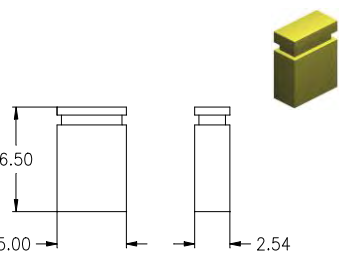
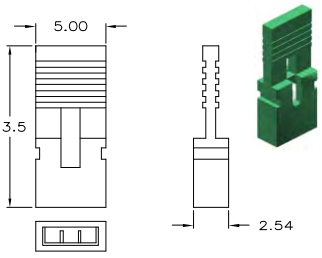
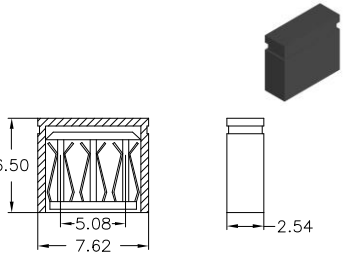
<p>JPE – type top open - commercial type -</p>  <p>Order Code: JPE – 254 – BL – 55 Other colours: GR, RD, BU, YL & WH</p>	<p>JPC – type top closed</p>  <p>Order Code: JPC – 254 – BL – 55 Other colours: GR, RD, BU, YL & WH</p>	<p>JPH – type with handle</p>  <p>Order Code: JPH – 254 – BL – 55 Other colours: GR, RD, BU, YL & WH</p>	<p>JPC – type top closed</p>  <p>Order Code: JPC – 508 – BL – 55</p>
--	---	---	---

2.00 mm Multi - Jumper

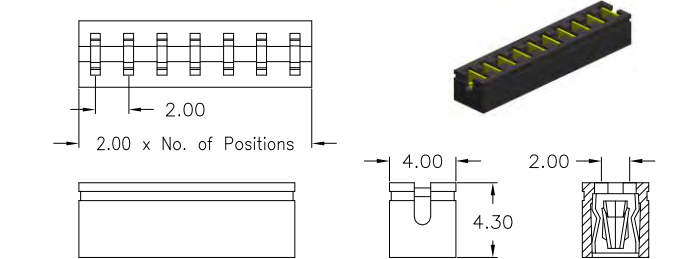
 <p>Order Code: JPM – xx – 200 – BL – 55 No. of Jumper : 02 to 11</p>

2.54 mm Multi - Jumper

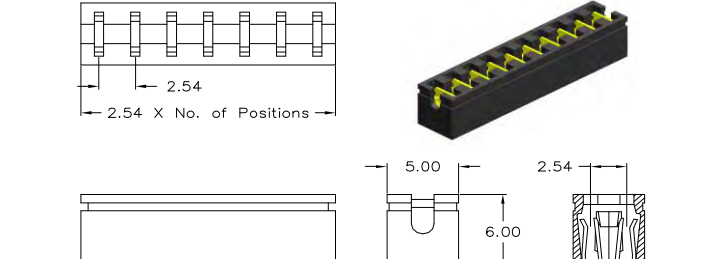
 <p>Order Code: JPM – xx – 254 – BL – 55 No. of Jumper : 02 to 10</p>

Non Insulated Wire Shorting Links

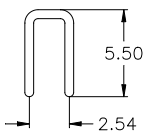
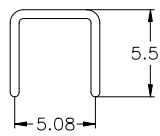
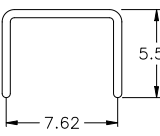
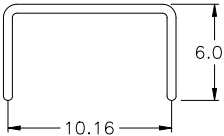
<p>JPW – type 254</p>  <p>Order Code: JPW – 254 – 55</p>	<p>JPW – type 508</p>  <p>Order Code: JPW – 508 – 55</p>	<p>JPW – type 762</p>  <p>Order Code: JPW – 762 – 55</p>	<p>JPW – type 102</p>  <p>Order Code: JPW – 102 – 55</p>
---	---	--	---

Specifications

Max. current rating	1.27 & 2.00mm pitch : 1 A 2.54 & 5.08mm pitch : 3 A
Insulation resistance	1000 MΩ min.
Contact resistance	20 mΩ max.
Withstanding voltage	500 V AC
Operating temperature	- 40°C to +105°C

Contact material	all pitch 2.54mm: Brass all others and JPM : PhPz
Plating	JPW : Brass; Ø 0.51 +0.25/-0.00
Insulator material	Jumper & Wire Shorting Links Au plated pitch 1.27mm & JPH : PA66 UL 94 V-2 all others: PBT UL 94 V-0
Colour attributes	BL = black for Jumpers Standard RD = red BU = blue GR = green WH = white YL = yellow other colours on request

IDC – DIP Plug 2.00mm x 2.00mm

IDC pitch 1.00mm

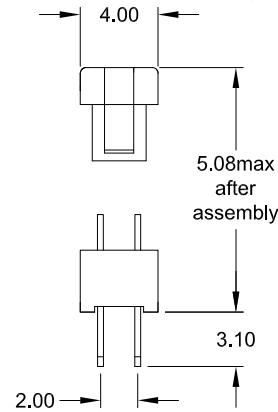
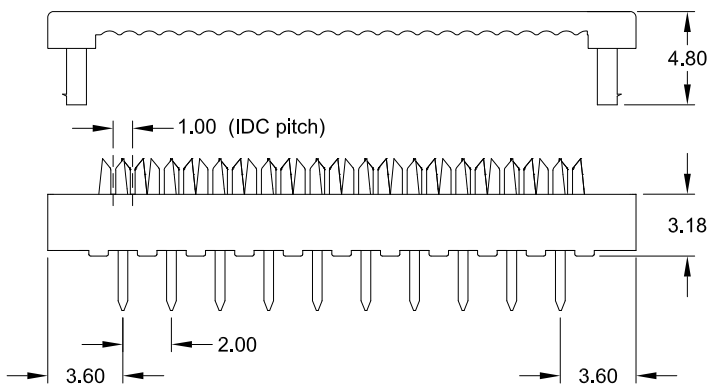
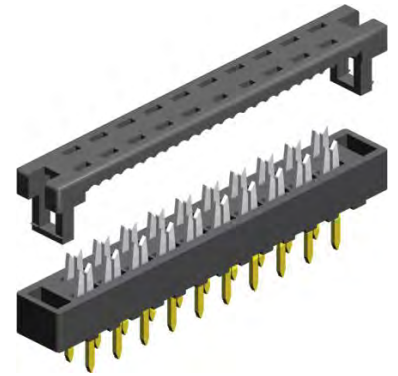

Application and Features

- A perfect solution for attaching a 1.00mm pitch flat ribbon cable to a PC-board
- Low-profile, only 5.08mm with cable
- Designed for direct soldering to a PC-board or plugging into DIP Socket

PCB Hole Layout

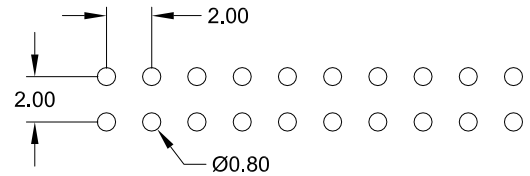

Specifications

Current rating	1 A	Operating temperature	- 40°C to +105°C
Insulation resistance	1000 MΩ min.	Contact material (RoHS compliant)	Phosphor Bronze
Contact resistance	30 mΩ max.	Insulator material (RoHS compliant)	PBT UL 94 V-0
Withstanding voltage	500 V AC		

How to order

IDP - xxx - S200 - N5

Nbr of contacts

006; 008; 010; 012
014; 016; 018; 020
022; 024; 026; 028
030; 034; 040; 044
050; 060; 068

Plating

N5

Ni on IDC area / Au on solder tail

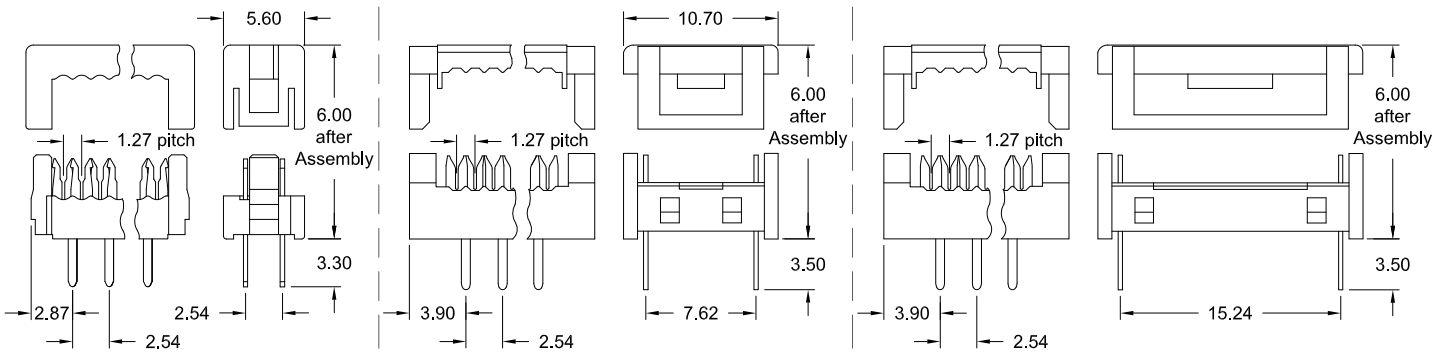
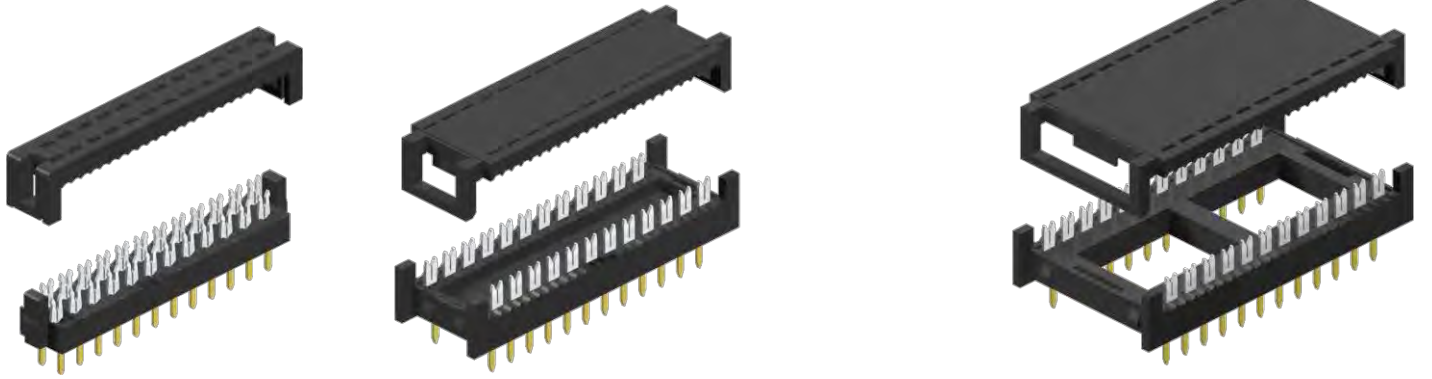

Style **S100** **S300** **S600**

APPLICATION AND FEATURES

- A perfect solution for attaching a 1.27mm pitch flat ribbon cable to a PC-board
- Low-profile, only 6.00mm height with cable
- Designed for direct soldering to a PC-Board or plugging into DIP Socket

PCB Hole Layout

S100

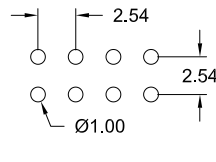

S300

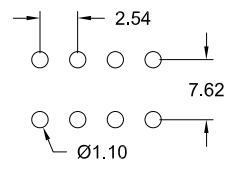

S600

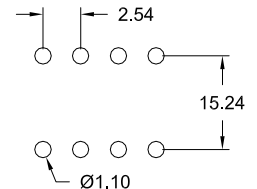

SPECIFICATIONS

Current rating	1 A	Operating temperature	- 40°C to +105°C
Insulator resistance	1000 MΩ min.	Contact material	Copper Alloy (RoHS compliant)
Contact resistance	30 mΩ max.	Insulator material	PBT UL 94 V-0 (RoHS compliant)
Withstanding voltage	500 V AC		

How to order

IDP - xxx - Sxxx - N5

Nbr of contacts			DIP Plug Style		Plating
S100 Style	S300 Style	S600 Style	Code	Pitch (mm)	
006; 008; 010 012; 014; 016 020; 024; 026 030; 034; 040 050; 060; 064	008; 010; 014 016; 018; 020 024; 028; 040	024; 028; 032 036; 040	S100	2.54	N5 Ni on IDC pierce area Au on solder tail
			S300	7.62	
			S600	15.24	

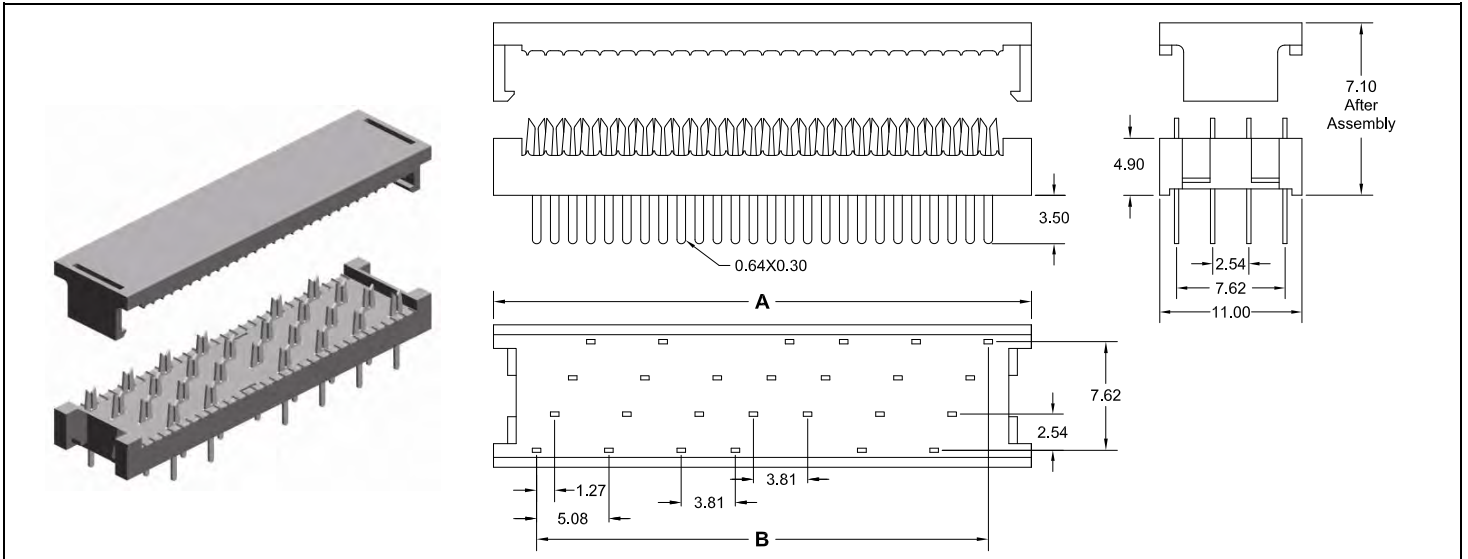

Dimensions

DIM	10 pos.	16 pos.	20 pos.	26 pos.	34 pos.	40 pos.	50 pos.
A	18.17 mm	25.79 mm	30.87 mm	38.49 mm	48.65 mm	56.27 mm	68.97 mm
B	11.43 mm	19.05 mm	24.13 mm	31.75 mm	41.91 mm	49.53 mm	62.23 mm

PCB Hole Layouts

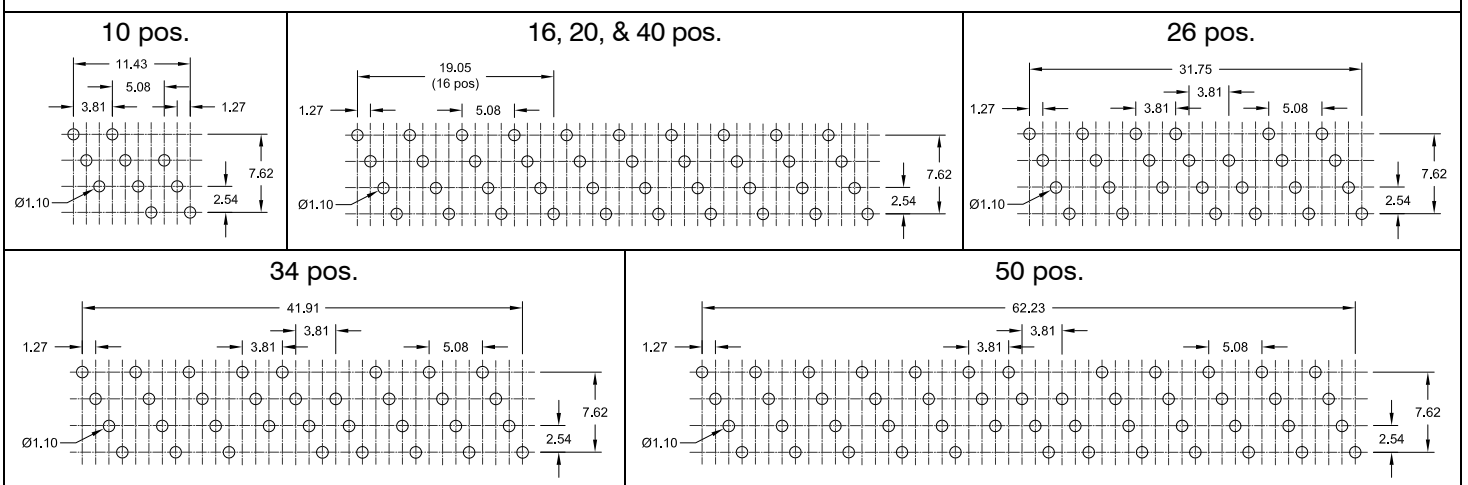

Application and Features

Designed for 1.27mm (.050") centre flat ribbon cable.
 Low profile with only 5.80mm above board after assembly.
 Designed for direct soldering to PCB.

Specifications

Current rating	1 A	Operating temperature	- 40°C to +105°C
Insulation resistance	1000 MΩ min.	Contact material (RoHS compliant)	Phosphor Bronze
Contact resistance	30 mΩ max.	Insulator material (RoHS compliant)	PBT UL 94 V-0
Withstanding voltage	500 V AC		

How to order

IDP - xxx - T050 - 99

Nbr of contacts

010; 016; 020; 026
034; 040; 050

Plating

99 = Tin (leadfree)
 other platings on request

PCI Card Edge Connector - THT -

1.27mm pitch



120 pin

PCI 32bit Order Code: **ECC-120-P050-95**

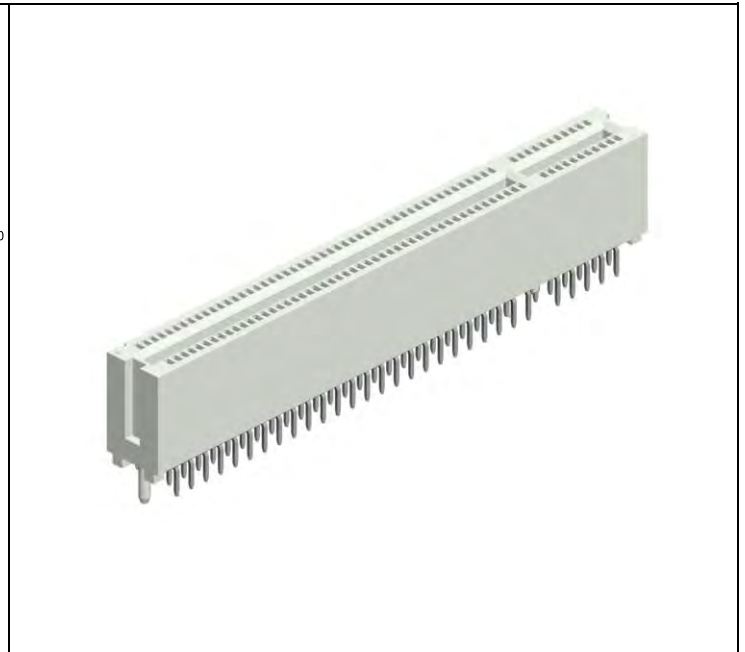

184 pin

PCI 64bit 3.3V Order Code: **ECC-184-P053-95**

184 pin

PCI 64bit 5V Order Code: **ECC-184-P055-95**

Application and Features

- Hi-rel dual beam contact assures reliable PC Board connections.
- Accepts PCB thickness of 1.57mm ±0.18
- 1.27mm contact center pitch.

Recommended Mating Board Dimensions

Specifications

Current rating	1 A	Contact material	Copper alloy (RoHS compliant)
Insulation resistance	1000 MΩ min.	Plating	Contact area Au over Ni
Contact resistance	30 mΩ max.		Soldertail area Sn over Ni
Withstanding voltage	500 V AC rms.		(tin leadfree)
	60Hz for 1 Minute	Insulator material	PA66 (white) UL 94 V-0
Capacitance	2pF max.		(RoHS compliant)
Voltage rating	250 V AC rms.	Insertion force	2.26N max. per contact pair
Operating temperature	- 55°C to +105°C	Withdrawal force	0.15N min. per contact pair

Card Edge Connector - THT - 1.27mm pitch

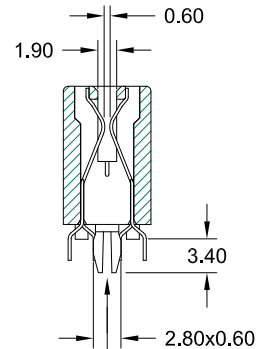
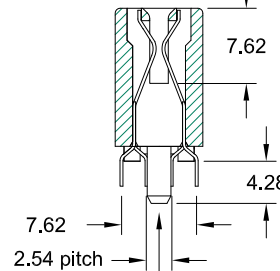
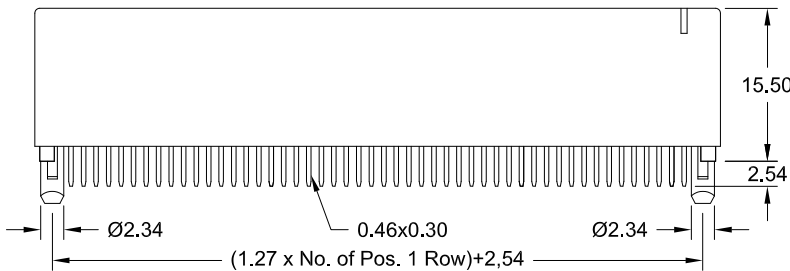
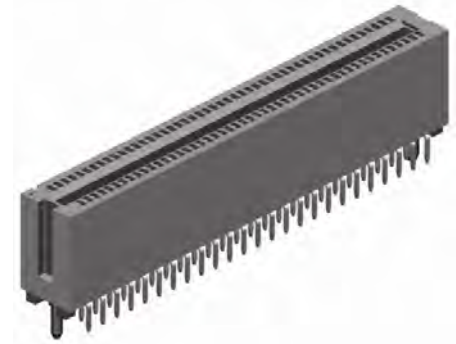
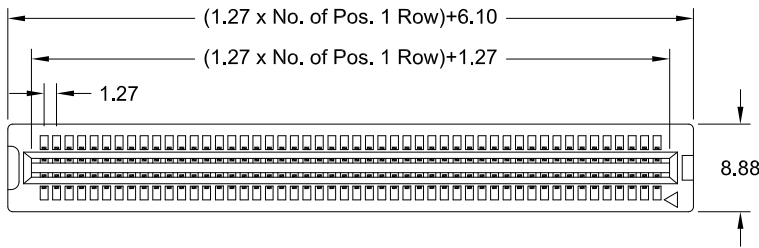

Plastic Peg
(Standard)

Metal Peg
(Option)

Application and Features

- Hi-rel dual beam contact assures reliable PC Board connections.
- Accepts PCB thickness of 1.57mm ±0.18
- 1.27mm contact center pitch.

PCB Hole Layout

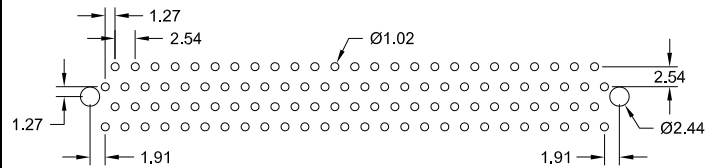

Specifications

Current rating	1 A
Insulation resistance	1000 MΩ min.
Contact resistance	30 mΩ max.
Withstanding voltage	500 V AC
Capacitance	2pF max.
Voltage rating	250 V

Operating temperature	- 55°C to +85°C
Contact material	Copper alloy (RoHS compliant)
Plating	Contact area - Au over Ni Solder tail area - Sn over Ni (tin leadfree)
Insulator material	PA66 (black) UL 94 V-0 (RoHS compliant)
Insertion force	2.26N max. per contact pair
Withdrawal force	0.15N min. per contact pair

How to order

ECC - xxx - S050 - 95 /X

Nbr of contacts
004; 006; 008; 010; 012; 014; 016;
018; 020 022; 024; 026; 028; 030
032; 034; 036; 038; 040; 042;044
046; 048; 050; 052; 054; 056
(058 only /N Type)
060; 080; 128
other contacts on request

Plating
95 = Tin/Gold (tin leadfree)
other platings on request

Peg Option
/N = Metal Peg
plastic peg is standard; no Option suffix

Card Edge Connector - THT - 2.54mm pitch "X" Contact Style

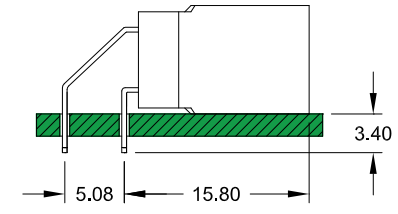
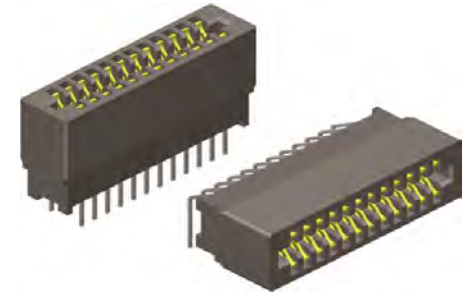
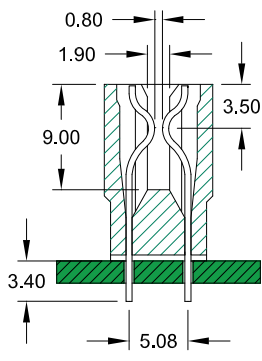
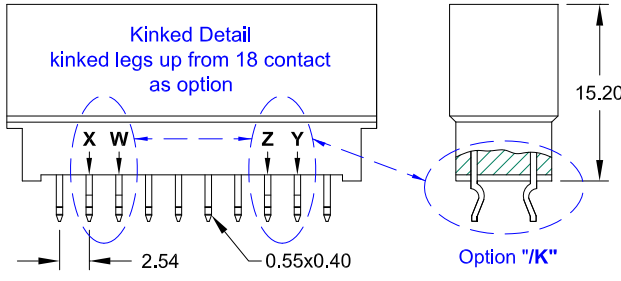
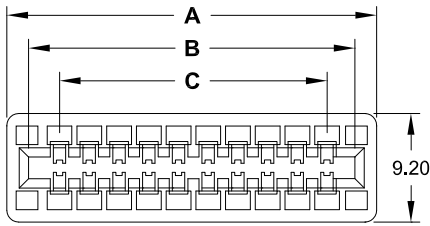

Application and Features

Hi-rel dual beam contact assures reliable PC-board connection.
Accepts PC Board thickness of 1.37mm to 1.78mm.
Straight type up from 18 contacts can be delivered with some kinked legs.
Pls. order separate datasheet for more options.

Connectors with mounting ears or solder eyes are also available.
Please contact your nearest sales office for more details.

"X" Contact Style



PCB Hole Layout

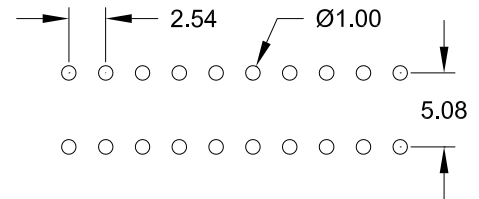

Important:

The PCB Layout is not identical for all pin count's.
Individual datasheets are available on request.

Specifications

Current rating 3 A
Insulation resistance 5000 MΩ min.
Contact resistance 20 mΩ max.
Withstanding voltage 1000 V AC

Operating temperature - 55°C to +85°C
Contact material (RoHS compliant) Brass
Insulator material (RoHS compliant) PBT UL 94 V-0
Insertion force 3.33N max. / pair
Withdrawal force 0.27N min. / pair

Dimensions

"S" Style kinked Option	No. of Contacts	DIM "A" mm	DIM "B" mm	DIM "C" mm	"S" Style kinked Option	No. of Contacts	DIM "A" mm	DIM "B" mm	DIM "C" mm	"S" Style kinked Option	No. of Contacts	DIM "A" mm	DIM "B" mm	DIM "C" mm
---	006	14.22	10.16	5.08	XY	028	42.16	38.10	33.02	XY	050	70.10	66.04	60.96
---	008	16.76	12.70	7.62	XY	030	44.70	40.64	35.56	XY	052	72.64	68.58	63.50
---	010	19.30	15.24	10.16	XY	032	47.24	43.18	38.10	XY	054	75.18	71.12	66.04
---	012	21.84	17.78	12.70	XY	034	49.78	45.72	40.64	XY	056	77.72	73.66	68.58
---	014	24.38	20.32	15.24	WXYZ	036	52.32	48.26	43.18	XY	058	80.26	76.20	71.12
---	016	26.92	22.86	17.78	XY	038	54.86	50.80	45.72	XY	060	82.80	78.74	73.66
XY	018	29.46	25.40	20.32	XY	040	57.40	53.34	48.26	WXYZ	062	85.34	81.28	76.20
XY	020	32.00	27.94	22.86	XY	042	59.94	55.88	50.80	WXYZ	064	87.88	83.82	78.74
XY	022	34.54	30.48	25.40	XY	044	62.48	58.42	53.34	WXYZ	068	92.96	88.90	83.82
XY	024	37.08	33.02	27.94	XY	046	65.02	60.96	55.88	WXYZ	070	95.50	91.44	86.36
WXYZ	026	39.62	35.56	30.48	XY	048	67.56	63.50	58.42	WXYZ	072	98.04	93.98	88.90

How to order

ECC - xxx /X - X 100 - 95

Nbr of contacts	Option	Connector Style	Plating
see above table	/K = if with kinked legs kinked legs for straight, S100 Style up from 18 contact possible	S = straight (with kinked legs possible) R = right angle (no kinked legs possible) Attention high MOQ's Refer to Connector Style SC100 and RC100 on page 89a for a close equivalent	95 = Tin/Gold (tin leadfree) other platings on request

Card Edge Connector - THT - 2.54mm pitch "M" Contact Style

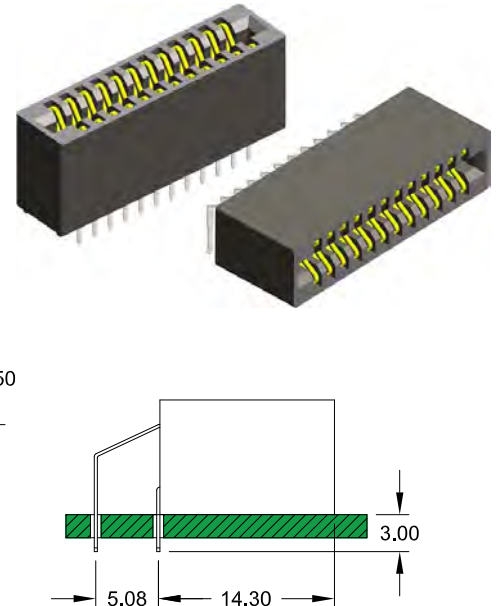
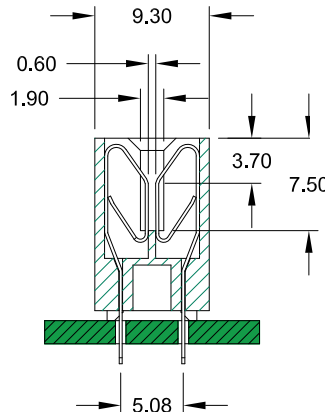
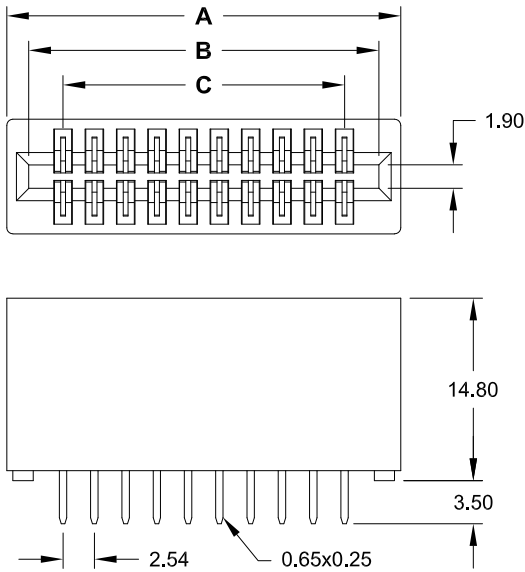

Application and Features

Hi-rel dual beam contact assures reliable PC-board connection.
Accepts PC Board thickness of 1.20mm to 1.60mm.

Connectors with mounting ears or solder eyes are also available.
Please contact your nearest sales office for more details.

"M" Contact Style



PCB Hole Layout

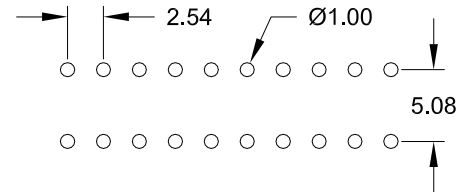

Important:

*The PCB Layout is not identical for all pin count's.
Individual datasheets are available on request.*

Specifications

Current rating 3 A
Insulation resistance 1000 MΩ min.
Contact resistance 20 mΩ max.
Withstanding voltage 1000 V AC

Operating temperature -55°C to +85°C
Contact material (RoHS compliant) Brass
Insulator material (RoHS compliant) PBT UL 94 V-0
Insertion force 3.33N max. / pair
Withdrawal force 0.27N min. / pair

Dimensions

Style	No. of Contacts	DIM "A" mm	DIM "B" mm	DIM "C" mm	Style	No. of Contacts	DIM "A" mm	DIM "B" mm	DIM "C" mm	Style	No. of Contacts	DIM "A" mm	DIM "B" mm	DIM "C" mm
S & R	006	14.22	10.66	5.08	S & R	030	44.70	41.14	35.56	S & R	054	75.18	71.62	66.04
S & R	008	16.76	13.20	7.62	S & R	032	47.24	43.68	38.10	S & R	056	77.72	74.16	68.58
S & R	010	19.30	15.74	10.16	S & R	034	49.78	46.22	40.64	S & R	058	80.26	76.70	71.12
S & R	012	21.84	18.28	12.70	S & R	036	52.32	48.76	43.18	S & R	060	82.80	79.24	73.66
S & R	014	24.38	20.82	15.24	S & R	038	54.86	51.30	45.72	S & R	062	85.34	81.78	76.20
S & R	016	26.92	23.36	17.78	S & R	040	57.40	53.84	48.26	S & R	064	87.88	84.32	78.74
S & R	018	29.46	25.90	20.32	S & R	042	59.94	56.38	50.80	S & R	066	90.42	86.86	81.28
S & R	020	32.00	28.44	22.86	S & R	044	62.48	58.92	53.34	S & R	068	92.96	89.40	83.82
S & R	022	34.54	30.98	25.40	S & R	046	65.02	61.46	55.88	S & R	070	95.50	91.94	86.36
S & R	024	37.08	33.52	27.94	S & R	048	67.56	64.00	58.42	S & R	072	98.04	94.48	88.90
S & R	026	39.62	36.06	30.48	S & R	050	70.10	66.54	60.96					
S & R	028	42.16	38.60	33.02	S & R	052	72.64	69.08	63.50					

How to order

ECC - xxx - XC100 - 95

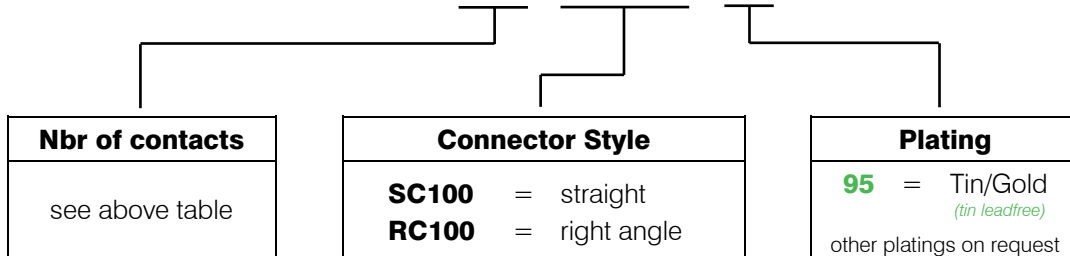

IDC – Card Edge Connector

2.54mm pitch

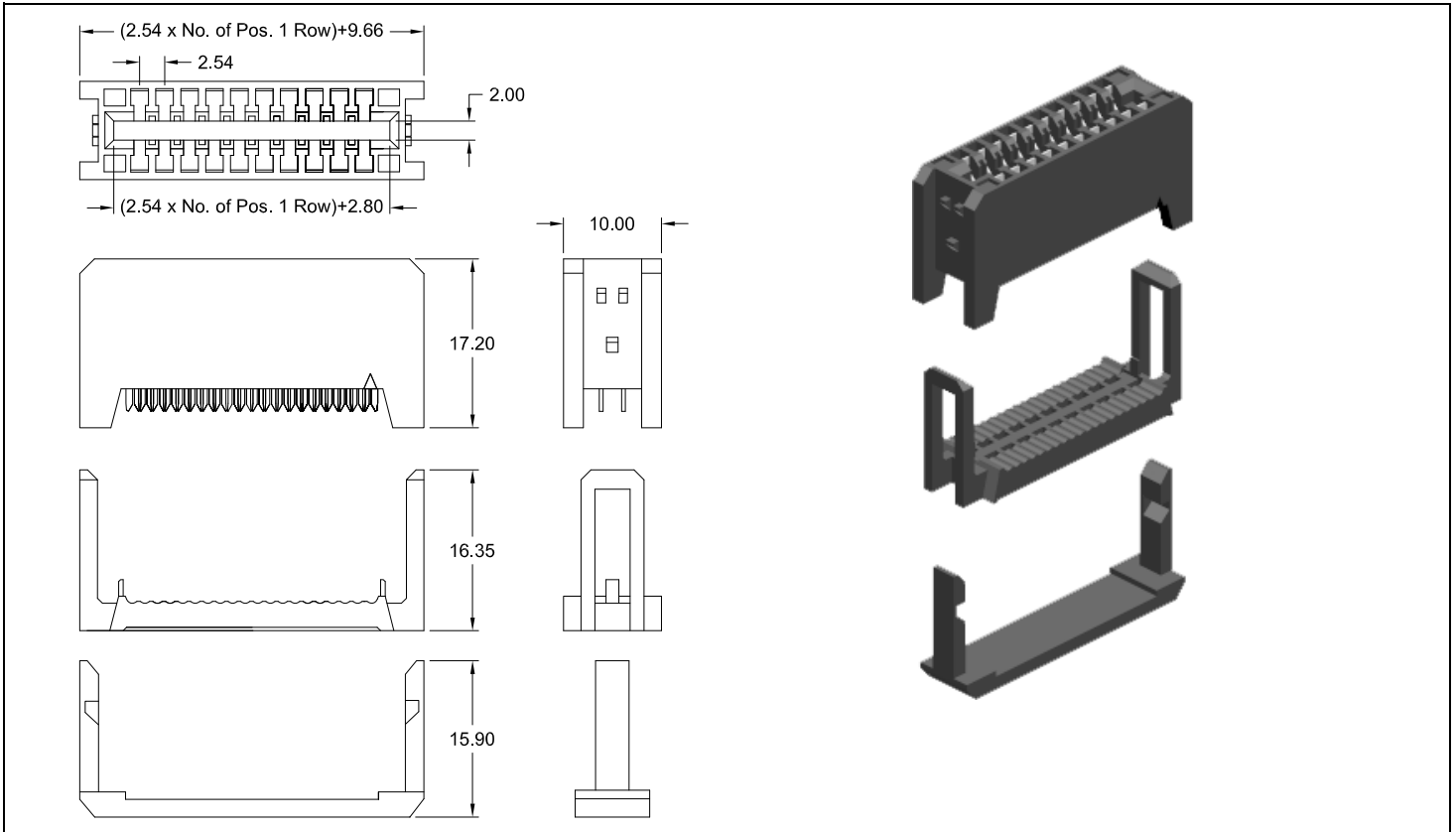

Specifications

Current rating	1 A
Insulation resistance	1000 MΩ min.
Contact resistance	20 mΩ max.
Withstanding voltage	500 V AC
Operating temperature	- 40°C to +105°C
Contact material (RoHS compliant)	Brass
Insulator material (RoHS compliant)	PBT UL 94 V-0

Recommended PCB dimensions

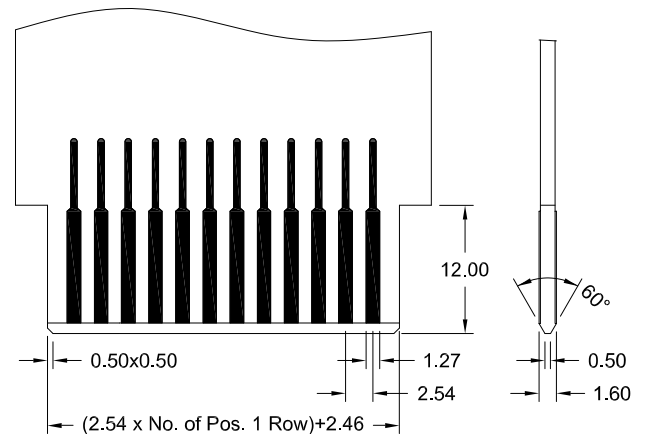

Application and Features

- Hi-rel dual beam contact for reliable PCB connections.
- Accepts PCB thickness of 1.37 to 1.78mm.
- Insulation displacement termination for 1.27mm flat cable AWG #28 or AWG #30 solid.

How to order

IDC - xxx - X 100 - N5

Nbr of contacts
010; 014; 016
020; 026; 034
040; 050

Strain relief
S = with
W = without

Plating
N5
Nickel in IDC & Gold in contact area
other platings on request

FPC/FFC Connector ZIF Type
- SMT - 0.50mm pitch vertical

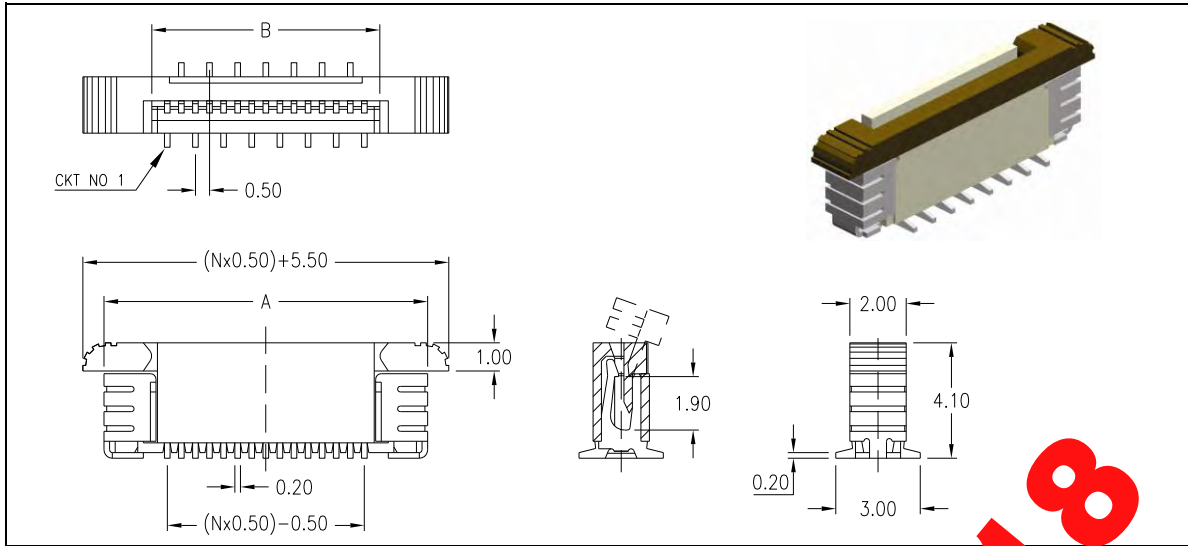

Standard:
Connector with
PickUp Cap
and Reel packing

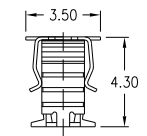
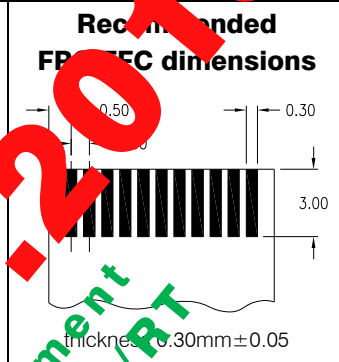
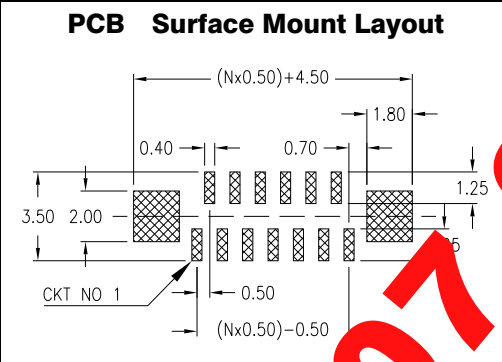
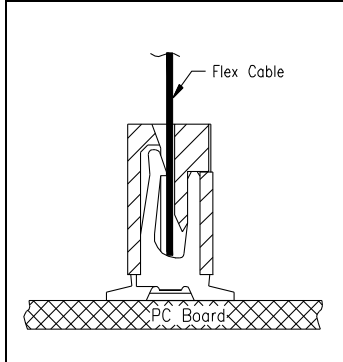
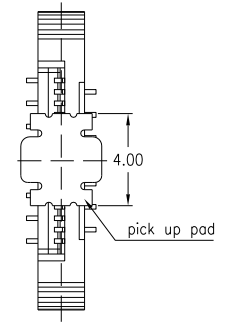

Please ask your sales office for details on Reel dimension.

SPECIFICATIONS

Current rating	0.4 A max.	Operating temperature	-55°C to +85°C
Insulator resistance	50 MΩ min.	Processing temperature	+250°C +0/-5°C for 3sec.
Contact resistance	30 mΩ max.	Contact material	Phosphor Bronze (RoHS compliant)
Withstanding voltage	250 V AC/1 M	Contact plating	Tin (leadfree)
		Insulator material	Nylon (RoHS compliant) UL 94 V-0

Dimensions (mm)

Contacts	DIM "A"	DIM "B"	Contacts	DIM "A"	DIM "B"	Contacts	DIM "A"	DIM "B"	Contacts	DIM "A"	DIM "B"
004	6.00	2.60	016	12.00	8.60	028	18.00	14.60	040	24.00	20.60
005	6.50	3.10	017	12.50	9.10	029	18.50	15.10	041	24.50	21.10
006	7.00	3.60	018	13.00	9.60	030	19.00	15.60	042	25.00	21.60
007	7.50	4.10	019	13.50	10.10	031	19.50	16.10	043	25.50	22.10
008	8.00	4.60	020	14.00	10.60	032	20.00	16.60	044	26.00	22.60
009	8.50	5.10	021	14.50	11.10	033	20.50	17.10	045	26.50	23.10
010	9.00	5.60	022	15.00	11.60	034	21.00	17.60	046	27.00	23.60
011	9.50	6.10	023	15.50	12.10	035	21.50	18.10	047	27.50	24.10
012	10.00	6.60	024	16.00	12.60	036	22.00	18.60	048	28.00	24.60
013	10.50	7.10	025	16.50	13.10	037	22.50	19.10	049	28.50	25.10
014	11.00	7.60	026	17.00	13.60	038	23.00	19.60	050	29.00	25.60
015	11.50	8.10	027	17.50	14.10	039	23.50	20.10			

How to order

FCZ - xxx - V 050 - 99 /RP

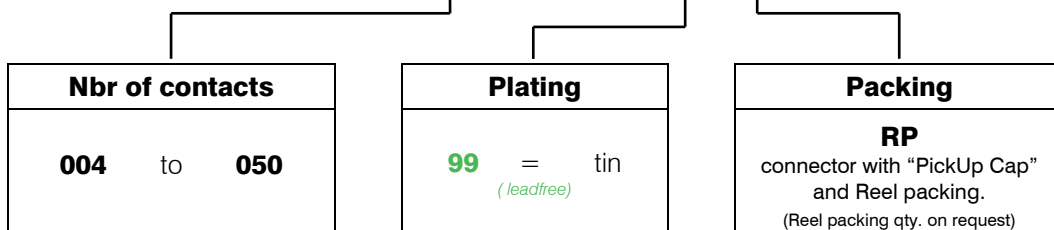

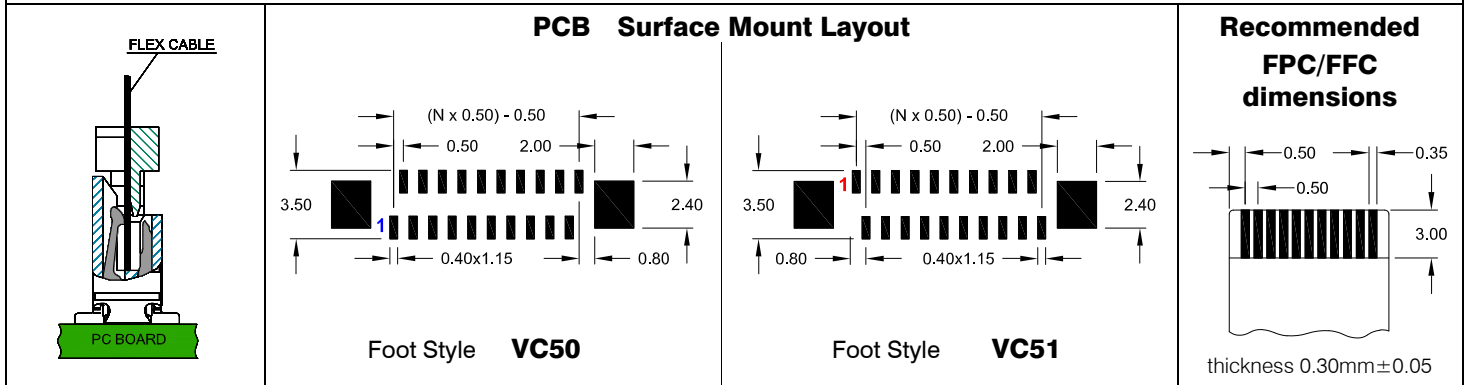
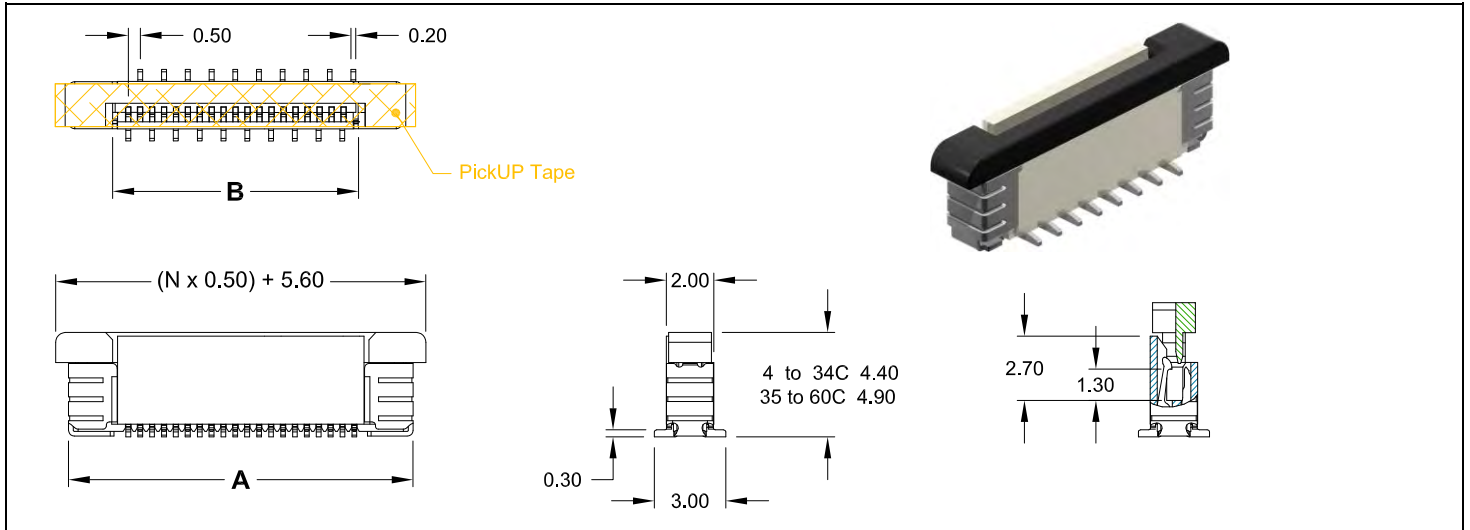

SPECIFICATIONS			
Current rating	0.5 A max.	Operating temperature	- 20°C to +85°C
Insulation resistance	500 MΩ min.	Processing temperature	+250°C +0/-5°C for 3sec.
Contact resistance	20 mΩ max.	Contact material	Phosphor Bronze
Withstanding voltage	200 V AC	Contact plating	Tin (<i>leadfree</i>)
		Insulator material	LCP UL 94 V-0

Dimensions (mm)											
Contacts	DIM "A"	DIM "B"	Contacts	DIM "A"	DIM "B"	Contacts	DIM "A"	DIM "B"	Contacts	DIM "A"	DIM "B"
004	6.50	2.60	019	14.00	10.10	034	21.50	17.60	049	29.00	25.10
005	7.00	3.10	020	14.50	10.60	035	22.00	18.10	050	29.50	25.60
006	7.50	3.60	021	15.00	11.10	036	22.50	18.60	051	30.00	26.10
007	8.00	4.10	022	15.50	11.60	037	23.00	19.10	052	30.50	26.60
008	8.50	4.60	023	16.00	12.10	038	23.50	19.60	053	31.00	27.10
009	9.00	5.10	024	16.50	12.60	039	24.00	20.10	054	31.50	27.60
010	9.50	5.60	025	17.00	13.10	040	24.50	20.60	055	32.00	28.10
011	10.00	6.10	026	17.50	13.60	041	25.00	21.10	056	32.50	28.60
012	10.50	6.60	027	18.00	14.10	042	25.50	21.60	057	33.00	29.10
013	11.00	7.10	028	18.50	14.60	043	26.00	22.10	058	33.50	29.60
014	11.50	7.60	029	19.00	15.10	044	26.50	22.60	059	34.00	30.10
015	12.00	8.10	030	19.50	15.60	045	27.00	23.10	060	34.50	30.60
016	12.50	8.60	031	20.00	16.10	046	27.50	23.60			
017	13.00	9.10	032	20.50	16.60	047	28.00	24.10			
018	13.50	9.60	033	21.00	17.10	048	28.50	24.60			

How to order

FCZ - xxx - VC xx - 99/RT

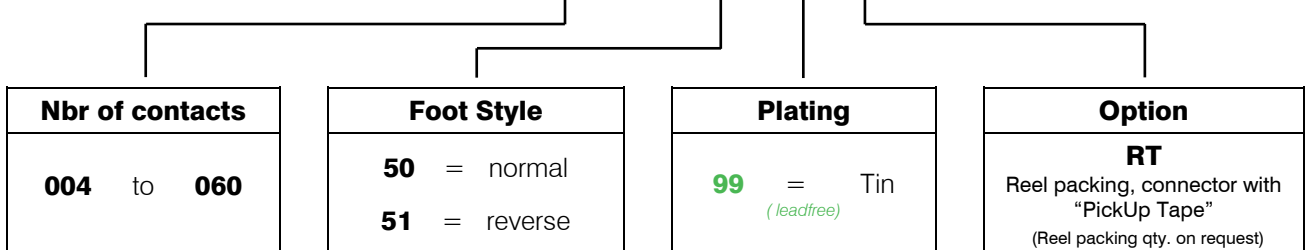

FPC/FFC Connector ZIF Type
- SMT - 0.50mm pitch horizontal

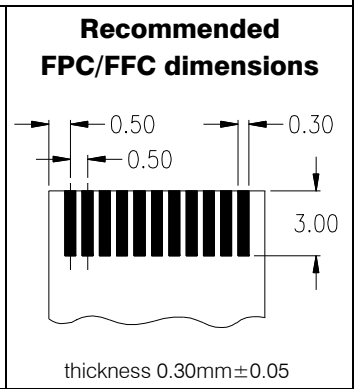
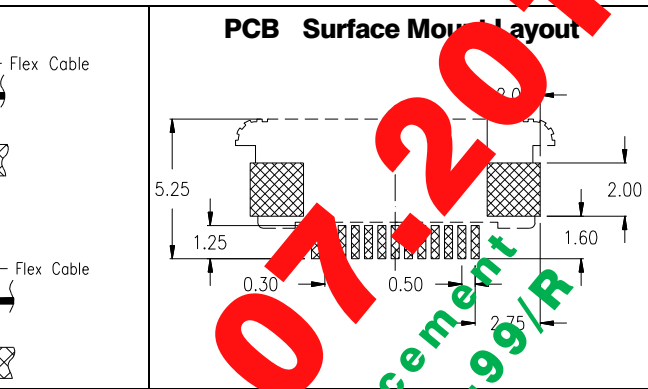
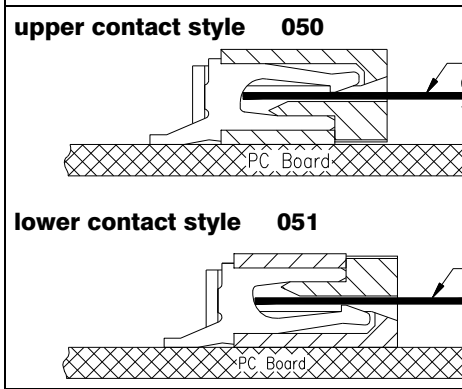
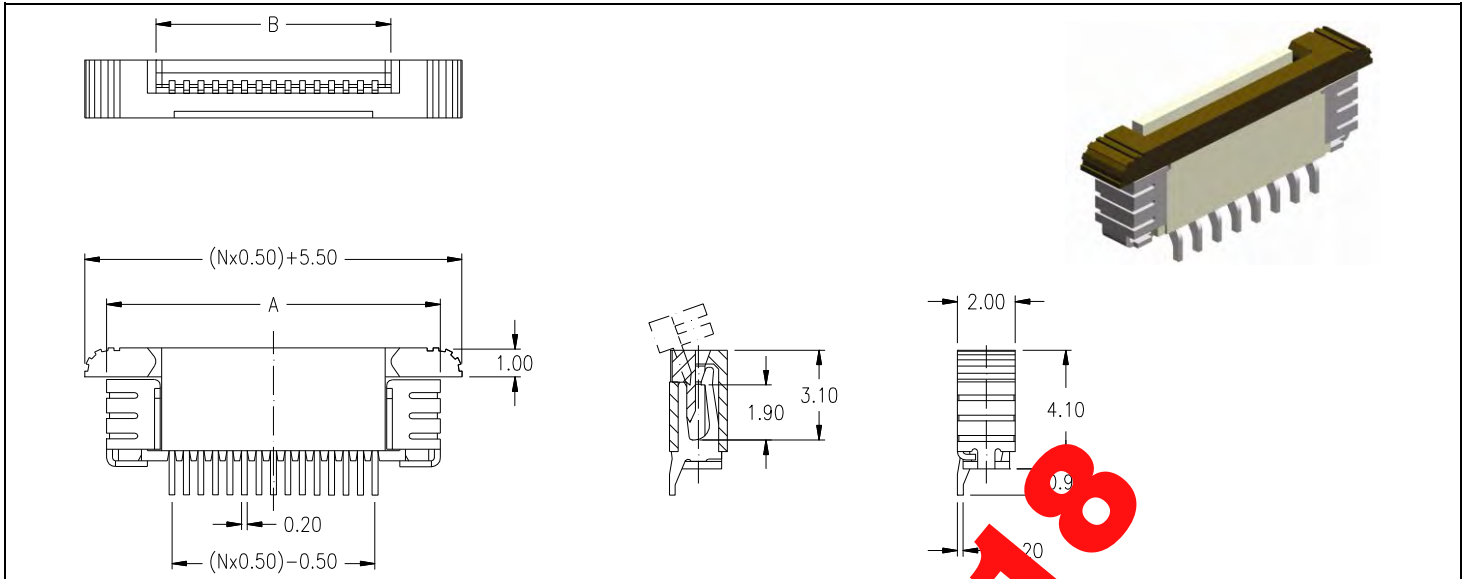

SPECIFICATIONS

Current rating	0.4 A max.	Operating temperature	-55°C to +85°C
Insulator resistance	50 MΩ	Processing temperature	+250°C +0/-5°C for 3sec.
Contact resistance	30 mΩ max.	Contact material	Phosphor Bronze (RoHS compliant)
Withstanding voltage	250 V AC/1 MVA	Contact plating	Tin (leadfree)
		Insulator material	Nylon (RoHS compliant) UL 94 V-0

Dimensions (mm)

Contacts	DIM "A"	DIM "B"	Contacts	DIM "A"	DIM "B"	Contacts	DIM "A"	DIM "B"	Contacts	DIM "A"	DIM "B"
004	6.00	2.60	016	12.00	8.60	028	18.00	14.60	040	24.00	20.60
005	6.50	3.10	017	12.50	9.10	029	18.50	15.10	041	24.50	21.10
006	7.00	3.60	018	13.00	9.60	030	19.00	15.60	042	25.00	21.60
007	7.50	4.10	019	13.50	10.10	031	19.50	16.10	043	25.50	22.10
008	8.00	4.60	020	14.00	10.60	032	20.00	16.60	044	26.00	22.60
009	8.50	5.10	021	14.50	11.10	033	20.50	17.10	045	26.50	23.10
010	9.00	5.60	022	15.00	11.60	034	21.00	17.60	046	27.00	23.60
011	9.50	6.10	023	15.50	12.10	035	21.50	18.10	047	27.50	24.10
012	10.00	6.60	024	16.00	12.60	036	22.00	18.60	048	28.00	24.60
013	10.50	7.10	025	16.50	13.10	037	22.50	19.10	049	28.50	25.10
014	11.00	7.60	026	17.00	13.60	038	23.00	19.60	050	29.00	25.60
015	11.50	8.10	027	17.50	14.10	039	23.50	20.10			

How to order

FCZ - xxx - H xxx - 99 / R

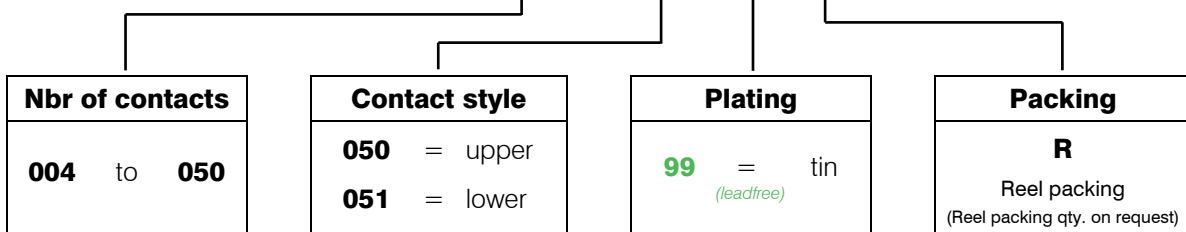

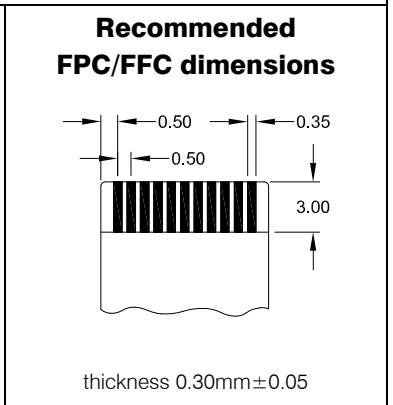
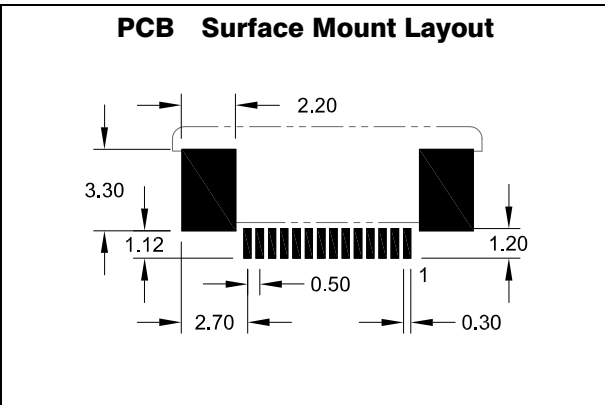
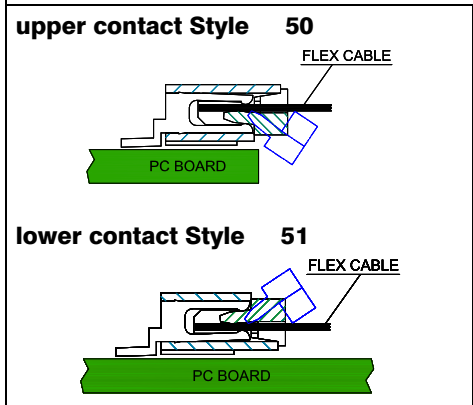
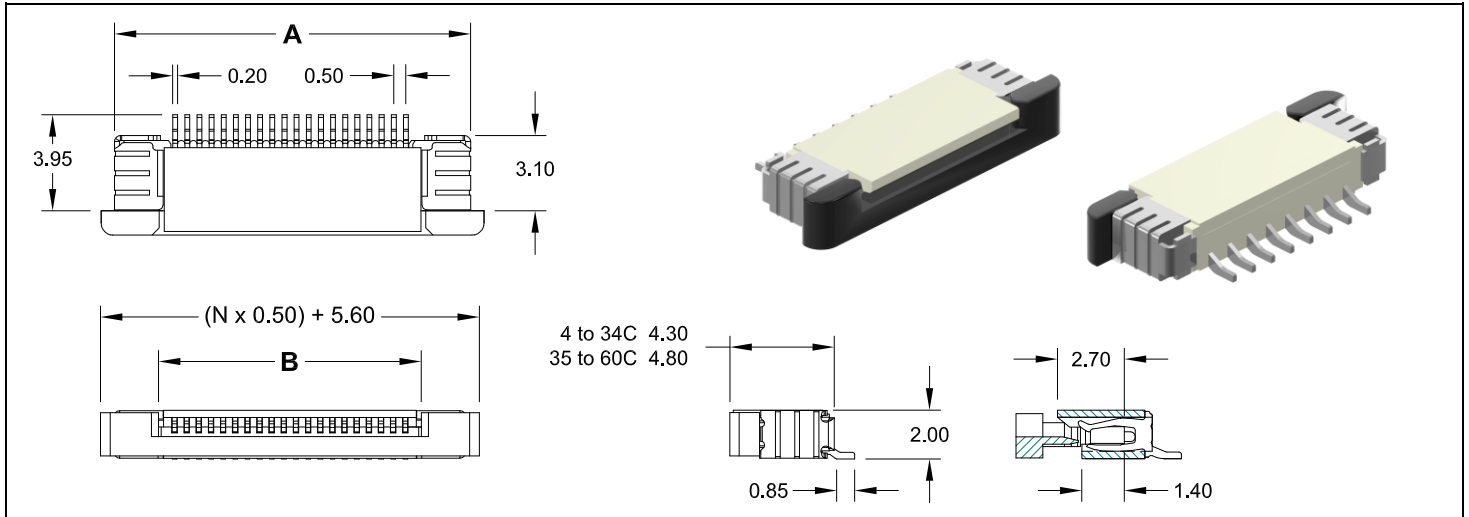

SPECIFICATIONS

Current rating	0.5 A max.	Operating temperature	- 20°C to +85°C
Insulation resistance	500 MΩ min.	Processing temperature	+250°C +0/-5°C for 3sec.
Contact resistance	20 mΩ max.	Contact material	Phosphor Bronze (RoHS compliant)
Withstanding voltage	200 V AC	Contact plating	Tin (leadfree)
		Insulator material	LCP (RoHS compliant) UL 94 V-0

Dimensions (mm)

Contacts	DIM "A"	DIM "B"	Contacts	DIM "A"	DIM "B"	Contacts	DIM "A"	DIM "B"	Contacts	DIM "A"	DIM "B"
004	6.50	2.60	019	14.00	10.10	034	21.50	17.60	049	29.00	25.10
005	7.00	3.10	020	14.50	10.60	035	22.00	18.10	050	29.50	25.60
006	7.50	3.60	021	15.00	11.10	036	22.50	18.60	051	30.00	26.10
007	8.00	4.10	022	15.50	11.60	037	23.00	19.10	052	30.50	26.60
008	8.50	4.60	023	16.00	12.10	038	23.50	19.60	053	31.00	27.10
009	9.00	5.10	024	16.50	12.60	039	24.00	20.10	054	31.50	27.60
010	9.50	5.60	025	17.00	13.10	040	24.50	20.60	055	32.00	28.10
011	10.00	6.10	026	17.50	13.60	041	25.00	21.10	056	32.50	28.60
012	10.50	6.60	027	18.00	14.10	042	25.50	21.60	057	33.00	29.10
013	11.00	7.10	028	18.50	14.60	043	26.00	22.10	058	33.50	29.60
014	11.50	7.60	029	19.00	15.10	044	26.50	22.60	059	34.00	30.10
015	12.00	8.10	030	19.50	15.60	045	27.00	23.10	060	34.50	30.60
016	12.50	8.60	031	20.00	16.10	046	27.50	23.60			
017	13.00	9.10	032	20.50	16.60	047	28.00	24.10			
018	13.50	9.60	033	21.00	17.10	048	28.50	24.60			

How to order

FCZ - xxx - HC xx - 99 /R

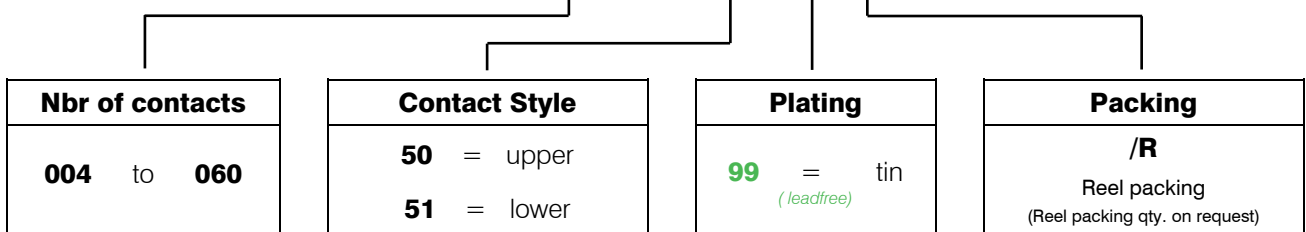

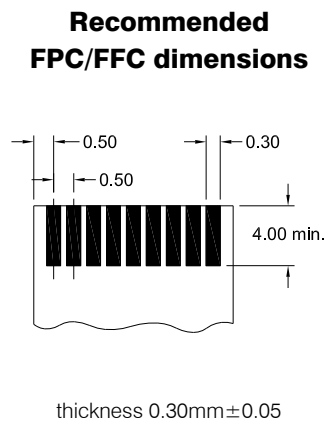
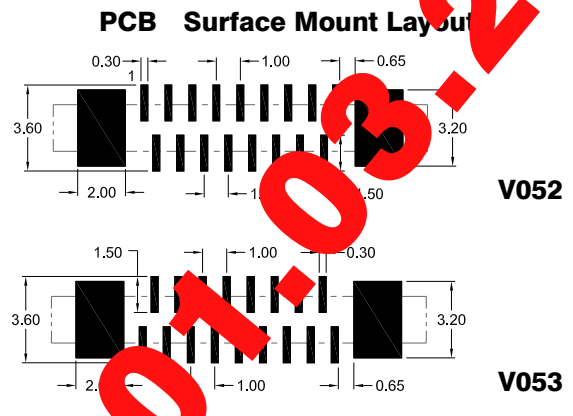
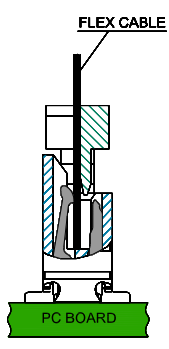
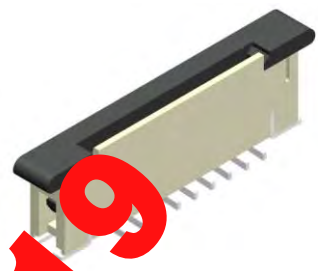
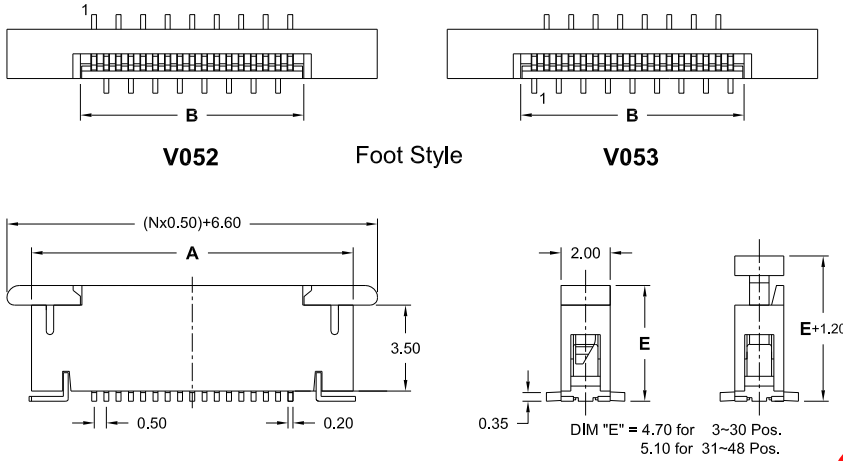

Specifications

Current rating	0.5 A max.	Operating temperature	-20°C to +85°C
Insulation resistance	500 MΩ min.	Processing temperature	+250°C +0/-5°C for 3sec.
Contact resistance	20 mΩ max.	Contact material	Phosphor Bronze (RoHS compliant)
Withstanding voltage	200 V AC	Contact plating	Tin (leadfree)
		Insulator material	PA46 UL 94 V-0 (RoHS compliant)
		Actuator material	PA9T UL 94 V-0 (RoHS compliant)

Dimensions (mm)

Contacts	DIM "A"	DIM "B"	Contacts	DIM "A"	DIM "B"	Contacts	DIM "A"	DIM "B"	Contacts	DIM "A"	DIM "B"
003	8.10	2.10	015	14.10	8.10	027	20.10	14.10	039	26.10	20.10
004	8.60	2.60	016	14.60	8.60	028	20.60	14.60	040	26.60	20.60
005	9.10	3.10	017	15.10	9.10	029	21.10	15.10	041	27.10	21.10
006	9.60	3.60	018	15.60	9.60	030	21.60	15.60	042	27.60	21.60
007	10.10	4.10	019	16.10	10.10	031	22.10	16.10	043	28.10	22.10
008	10.60	4.60	020	16.60	10.60	032	22.60	16.60	044	28.60	22.60
009	11.10	5.10	021	17.10	11.10	033	23.10	17.10	045	29.10	23.10
010	11.60	5.60	022	17.60	11.60	034	23.60	17.60	046	29.60	23.60
011	12.10	6.10	023	18.10	12.10	035	24.10	18.10	047	30.10	24.10
012	12.60	6.60	024	18.60	12.60	036	24.60	18.60	048	30.60	24.60
013	13.10	7.10	025	19.10	13.10	037	25.10	19.10			
014	13.60	7.60	026	19.60	13.60	038	25.60	19.60			

How to order

FCZ - xxx - V xxx - 99 /X

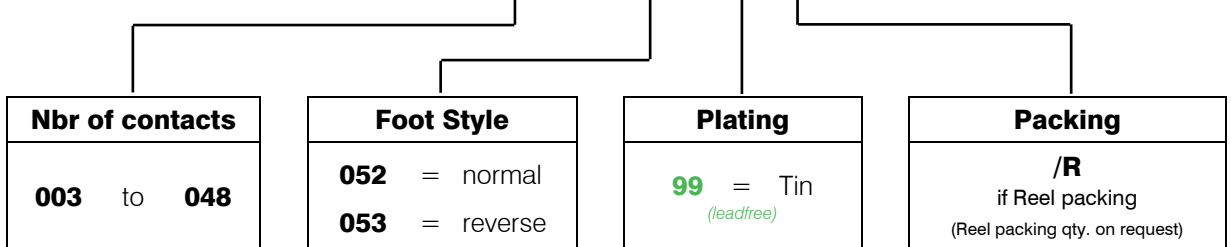

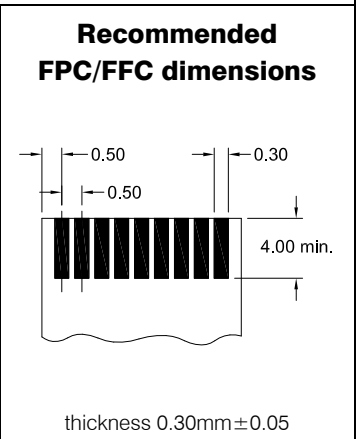
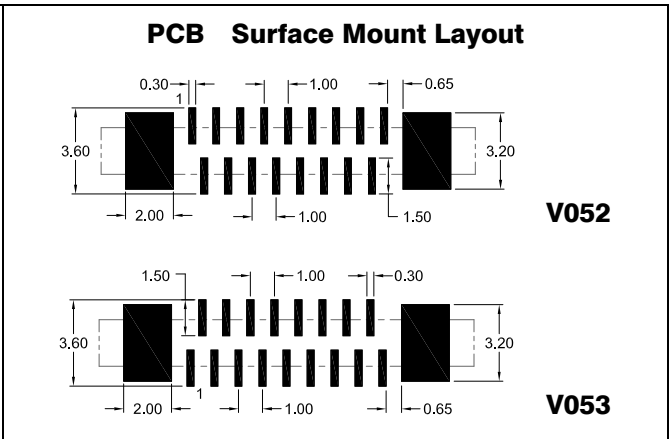
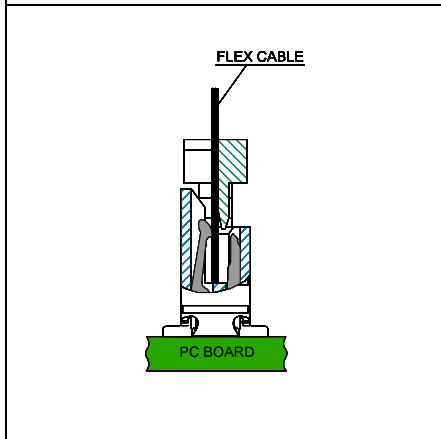
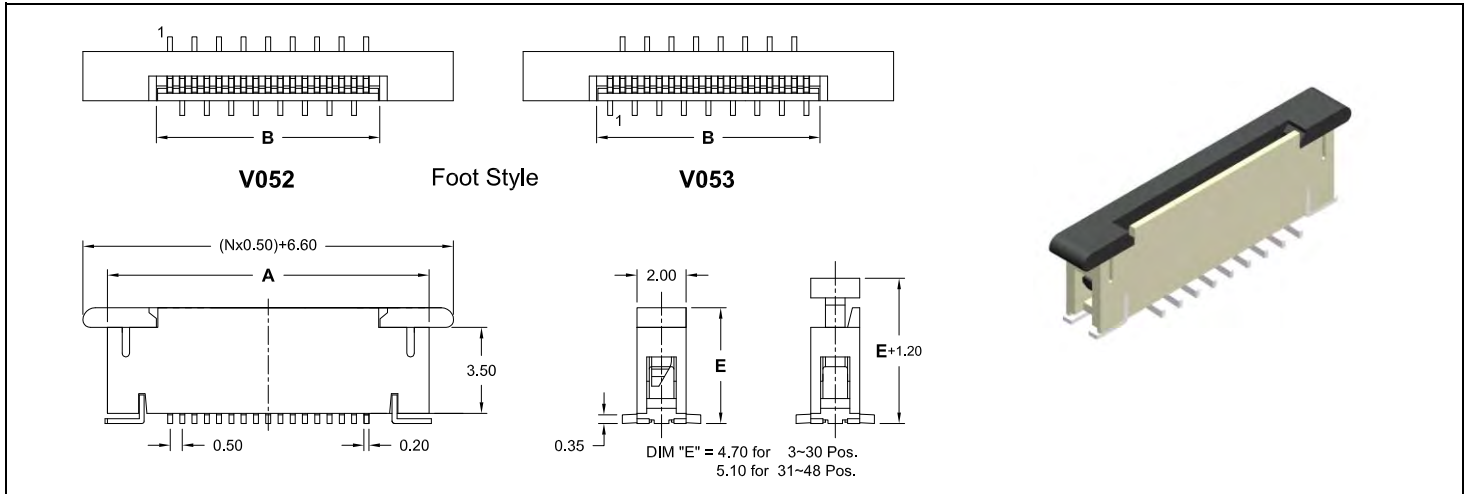

Specifications

Current rating	0.5 A max.	Operating temperature	-20°C to +85°C
Insulation resistance	500 MΩ min.	Processing temperature	+250°C +0/-5°C for 3sec.
Contact resistance	20 mΩ max.	Contact material	Phosphor Bronze (RoHS compliant)
Withstanding voltage	200 V AC	Contact plating	Tin (leadfree)
		Insulator material	PA46 UL 94 V-0 (RoHS compliant)
		Actuator material	PA9T UL 94 V-0 (RoHS compliant)

Dimensions (mm)

Contacts	DIM "A"	DIM "B"	Contacts	DIM "A"	DIM "B"	Contacts	DIM "A"	DIM "B"	Contacts	DIM "A"	DIM "B"
003	8.10	2.10	015	14.10	8.10	027	20.10	14.10	039	26.10	20.10
004	8.60	2.60	016	14.60	8.60	028	20.60	14.60	040	26.60	20.60
005	9.10	3.10	017	15.10	9.10	029	21.10	15.10	041	27.10	21.10
006	9.60	3.60	018	15.60	9.60	030	21.60	15.60	042	27.60	21.60
007	10.10	4.10	019	16.10	10.10	031	22.10	16.10	043	28.10	22.10
008	10.60	4.60	020	16.60	10.60	032	22.60	16.60	044	28.60	22.60
009	11.10	5.10	021	17.10	11.10	033	23.10	17.10	045	29.10	23.10
010	11.60	5.60	022	17.60	11.60	034	23.60	17.60	046	29.60	23.60
011	12.10	6.10	023	18.10	12.10	035	24.10	18.10	047	30.10	24.10
012	12.60	6.60	024	18.60	12.60	036	24.60	18.60	048	30.60	24.60
013	13.10	7.10	025	19.10	13.10	037	25.10	19.10			
014	13.60	7.60	026	19.60	13.60	038	25.60	19.60			

How to order

FCZ - xxx - V xxx - 99 /X

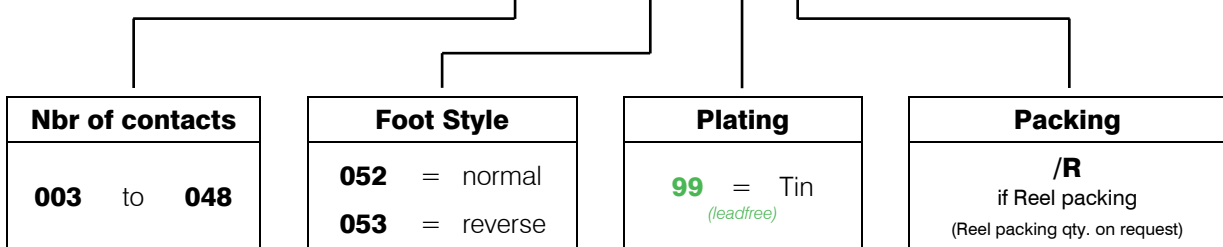

FPC/FFC Connector **ZIF Type**
 - SMT - 0.50mm pitch horizontal

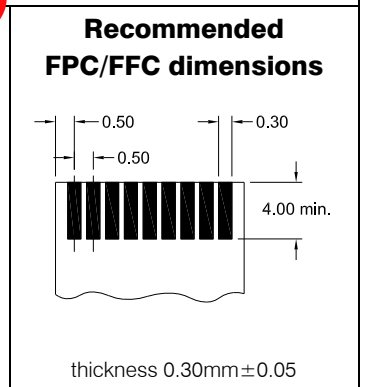
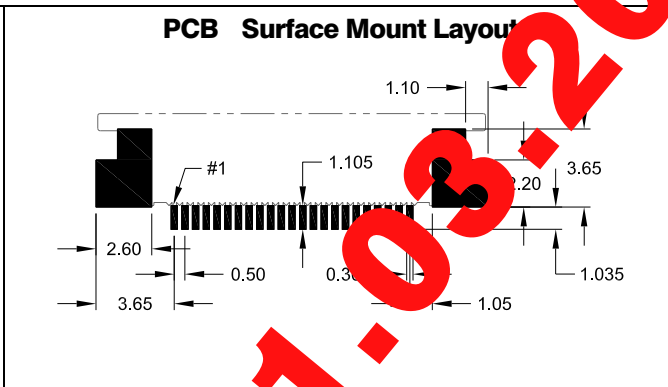
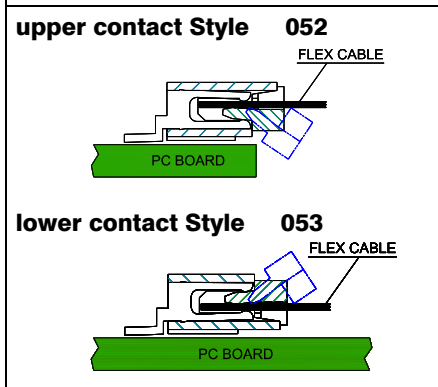
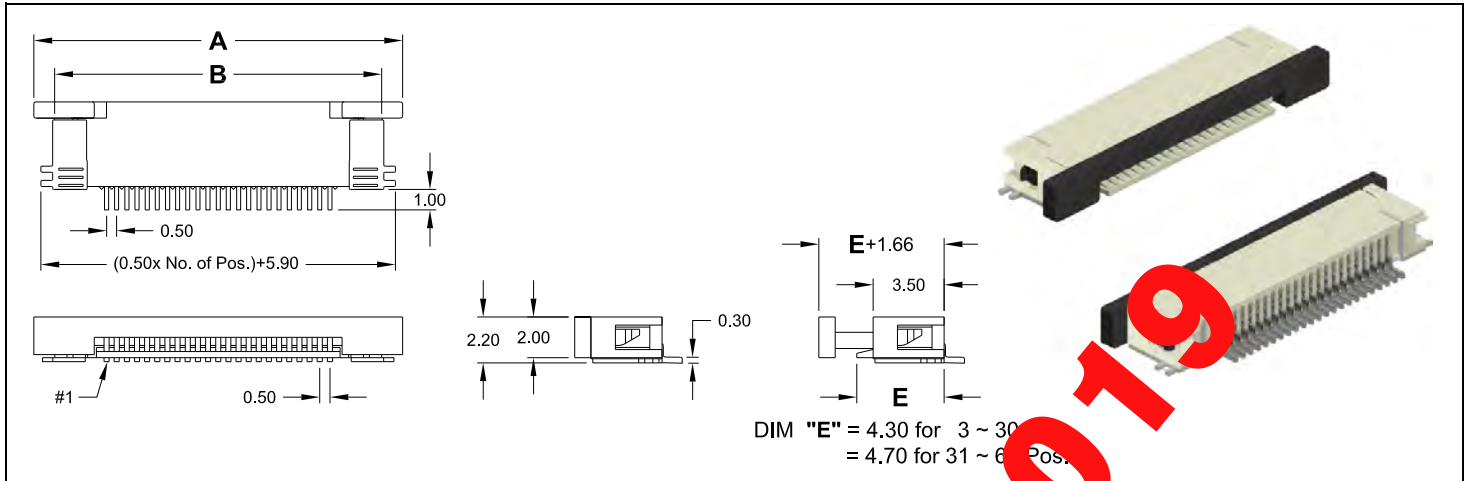

Specifications			
Current rating	0.5 A max.	Operating temperature	- 20°C to +80°C
Insulation resistance	500 MΩ min.	Processing temperature	+250°C +0/-5°C for 3sec.
Contact resistance	20 mΩ max.	Contact material	Phosphor Bronze (RoHS compliant)
Withstanding voltage	200 V AC	Contact plating	Tin (leadfree)
		Insulator material	PA46 UL 94 V-0 (RoHS compliant)
		Actuator material	PA9T UL 94 V-0 (RoHS compliant)

Dimensions (mm)											
Contacts	DIM "A"	DIM "B"	Contacts	DIM "A"	DIM "B"	Contacts	DIM "A"	DIM "B"	Contacts	DIM "A"	DIM "B"
003	8.10	6.10	018	15.60	13.60	033	23.10	21.10	048	30.60	28.60
004	8.60	6.60	019	16.10	14.10	034	23.60	21.60	049	31.10	29.10
005	9.10	7.10	020	16.60	14.60	035	24.10	22.10	050	31.60	29.60
006	9.60	7.60	021	17.10	15.10	036	24.60	22.60	051	32.10	30.10
007	10.10	8.10	022	17.60	15.60	037	25.10	23.10	052	32.60	30.60
008	10.60	8.60	023	18.10	16.10	038	25.60	23.60	053	33.10	31.10
009	11.10	9.10	024	18.60	16.60	039	26.10	24.10	054	33.60	31.60
010	11.60	9.60	025	19.10	17.10	040	26.60	24.60	055	34.10	32.10
011	12.10	10.10	026	19.60	17.60	041	27.10	25.10	056	34.60	32.60
012	12.60	10.60	027	20.10	18.10	042	27.60	25.60	057	35.10	33.10
013	13.10	11.10	028	20.60	18.60	043	28.10	26.10	058	35.60	33.60
014	13.60	11.60	029	21.10	19.10	044	28.60	26.60	059	36.10	34.10
015	14.10	12.10	030	21.60	19.60	045	29.10	27.10	060	36.60	34.60
016	14.60	12.60	031	22.10	20.10	046	29.60	27.60			
017	15.10	13.10	032	22.60	20.60	047	30.10	28.10			

How to order

FCZ - xxx - H xxx - 99 /X

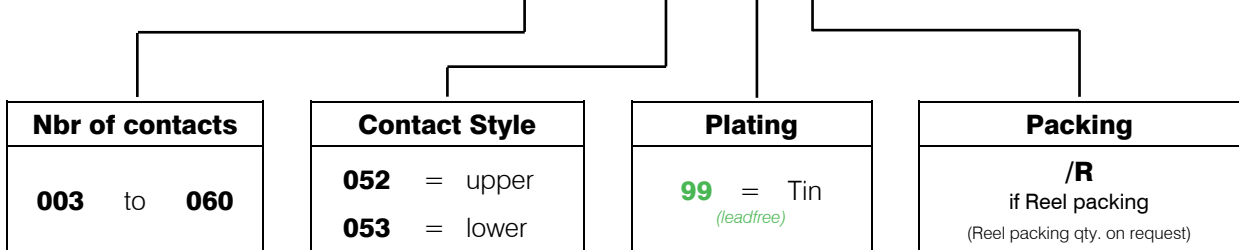

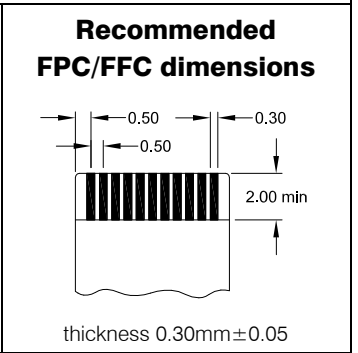
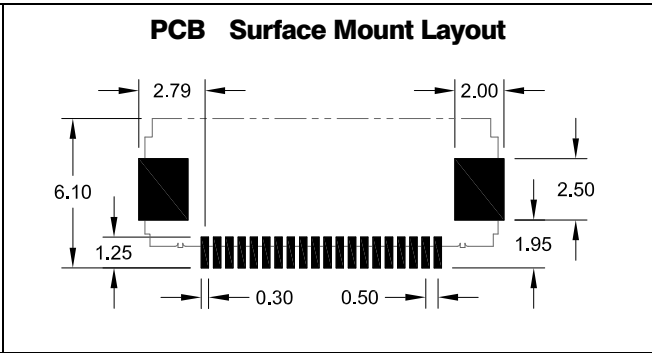
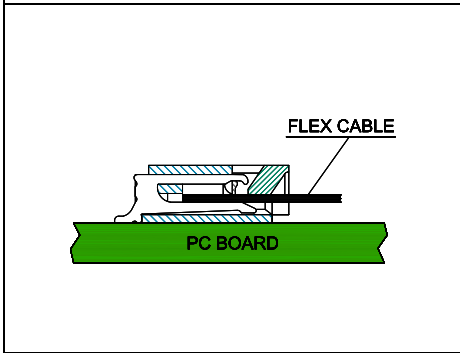
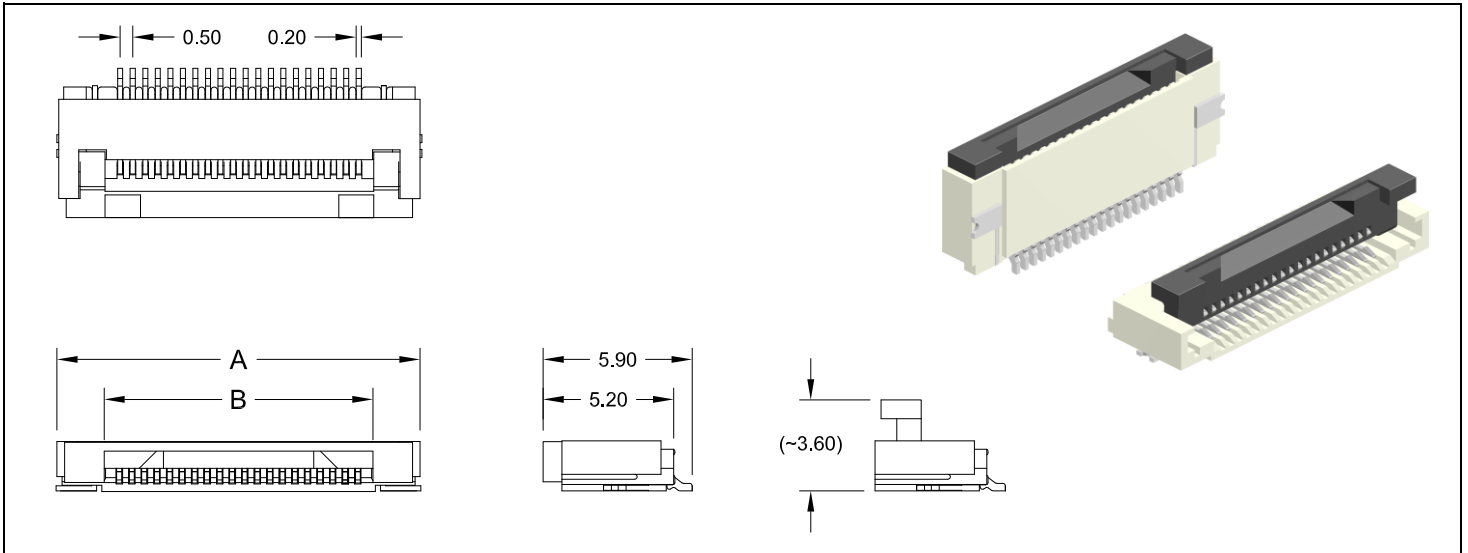

Specifications

Current rating	0.5 A max.	Operating temperature	- 20°C to +85°C
Insulation resistance	500 MΩ min.	Processing temperature	+250°C +0/-5°C for 3sec.
Contact resistance	20 mΩ max.	Contact material	Phosphor Bronze (RoHS compliant)
Withstanding voltage	200 V AC	Contact plating	Tin (leadfree)
		Insulator material	LCP (Natural) UL 94 V-0 (RoHS compliant)
		Actuator material	LCP (Black) UL 94 V-0 (RoHS compliant)

Dimensions (mm)

Contacts	DIM "A"	DIM "B"	Contacts	DIM "A"	DIM "B"	Contacts	DIM "A"	DIM "B"	Contacts	DIM "A"	DIM "B"
006	7.40	3.60	020	14.40	10.60	034	21.40	17.60	048	28.40	24.60
007	7.90	4.10	021	14.90	11.10	035	21.90	18.10	049	28.90	25.10
008	8.40	4.60	022	15.40	11.60	036	22.40	18.60	050	29.40	25.60
009	8.90	5.10	023	15.90	12.10	037	22.90	19.10	051	29.90	26.10
010	9.40	5.60	024	16.40	12.60	038	23.40	19.60	052	30.40	26.60
011	9.90	6.10	025	16.90	13.10	039	23.90	20.10	053	30.90	27.10
012	10.40	6.60	026	17.40	13.60	040	24.40	20.60	054	31.40	27.60
013	10.90	7.10	027	17.90	14.10	041	24.90	21.10	055	31.90	28.10
014	11.40	7.60	028	18.40	14.60	042	25.40	21.60	056	32.40	28.60
015	11.90	8.10	029	18.90	15.10	043	25.90	22.10	057	32.90	29.10
016	12.40	8.60	030	19.40	15.60	044	26.40	22.60	058	33.40	29.60
017	12.90	9.10	031	19.90	16.10	045	26.90	23.10	059	33.90	30.10
018	13.40	9.60	032	20.40	16.60	046	27.40	23.60	060	34.40	30.60
019	13.90	10.10	033	20.90	17.10	047	27.90	24.10			

How to order

FCZ - xxx - H058 - 99 /X

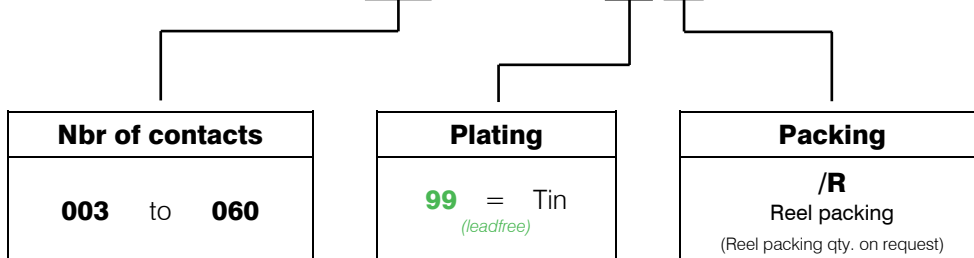

FPC/FFC Connector **ZIF** "Easy-on" Type
 - SMT - 0.80mm pitch horizontal

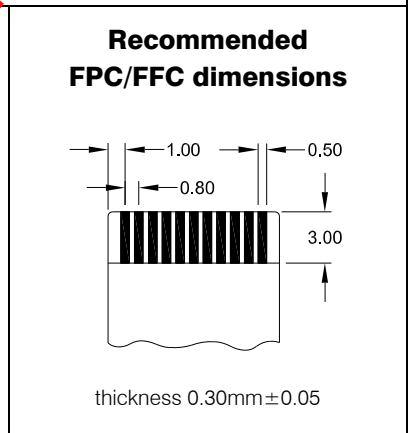
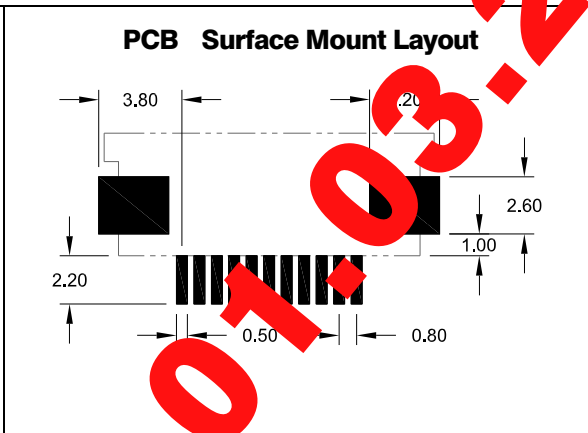
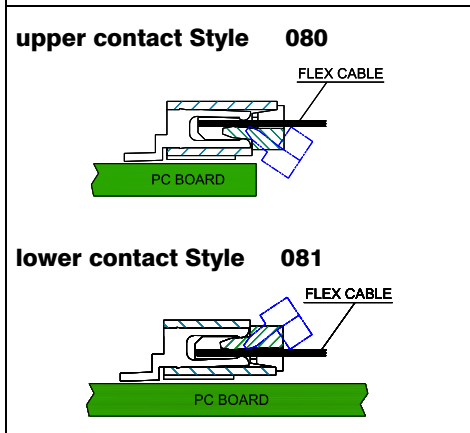
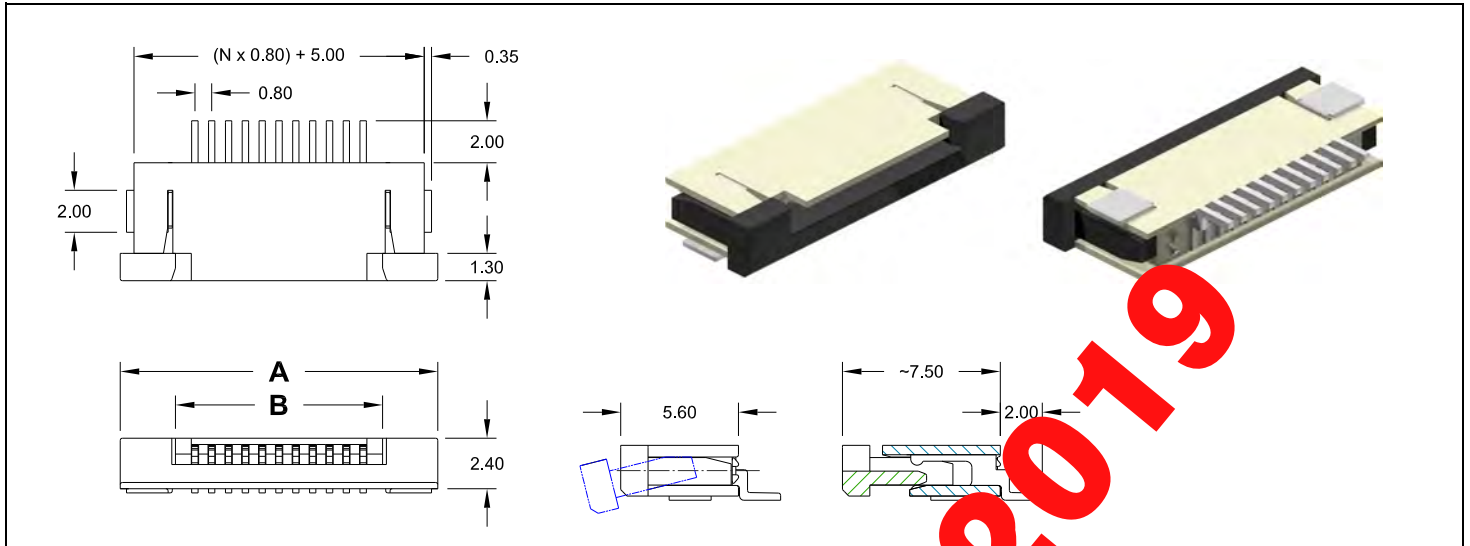

Specifications

Current rating	0.5 A max.	Operating temperature	-20°C to +85°C
Insulation resistance	500 MΩ min.	Processing temperature	+250°C +0/-5°C for 3sec.
Contact resistance	20 mΩ max.	Contact material	Phosphor Bronze (RoHS compliant)
Withstanding voltage	200 V AC	Contact plating	Tin (leadfree)
		Insulator material	LCP (white) UL 94 V-0 (RoHS compliant)
		Actuator material	PA46 (black) UL 94 V-0 (RoHS compliant)

Dimensions (mm)

Contacts	DIM "A"	DIM "B"	Contacts	DIM "A"	DIM "B"	Contacts	DIM "A"	DIM "B"	Contacts	DIM "A"	DIM "B"
004	9.50	4.84	012	15.90	11.24	020	22.30	17.64	028	28.70	24.04
005	10.30	5.64	013	16.70	12.04	021	23.10	18.44	029	29.50	24.84
006	11.10	6.44	014	17.50	12.84	022	23.90	19.24	030	30.30	25.64
007	11.90	7.24	015	18.30	13.64	023	24.70	20.04	031	31.10	26.44
008	12.70	8.04	016	19.10	14.44	024	25.50	20.84	032	31.90	27.24
009	13.50	8.84	017	19.90	15.24	025	26.30	21.64			
010	14.30	9.64	018	20.70	16.04	026	27.10	22.44			
011	15.10	10.44	019	21.50	16.84	027	27.90	23.24			

How to order

FCZ - xxx - H xxx - 99 /X

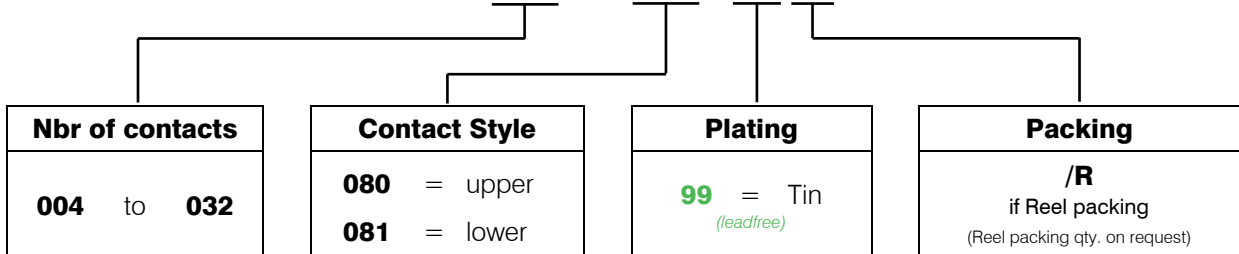

FPC/FFC Connector ZIF Type

- SMT - 1.00mm pitch vertical



Standard:
Connector with PickUp Cap and Reel packing

Flex Cable
PC Board

PCB Surface Mount Layout

Recommended FPC/FFC dimensions

thickness 0.30mm ± 0.05

Please ask your sales office for details on Reel dimension.

SPECIFICATIONS			
Current rating	0.4 A max.	Operating temperature	-55°C to +85°C
Insulator resistance	50 MΩ min.	Processing temperature	+250°C +0/-5°C for 3 sec.
Contact resistance	30 mΩ max.	Contact material	Phosphor Bronze
Withstanding voltage	250 V AC/1 Min.	Contact plating	Tin (leadfree)
		Insulator material	Nylon UL 94 V-0

Dimensions (mm)											
Contacts	DIM "A"	DIM "B"	Contacts	DIM "A"	DIM "B"	Contacts	DIM "A"	DIM "B"	Contacts	DIM "A"	DIM "B"
004	8.50	5.10	010	14.50	11.10	016	20.50	17.10	022	26.50	23.10
005	9.50	6.10	011	15.50	12.10	017	21.50	18.10	023	27.50	24.10
006	10.50	7.10	012	16.50	13.10	018	22.50	19.10	024	28.50	25.10
007	11.50	8.10	013	17.50	14.10	019	23.50	20.10			
008	12.50	9.10	014	18.50	15.10	020	24.50	21.10			
009	13.50	10.10	015	19.50	16.10	021	25.50	22.10			

How to order

FCZ - xxx - V 100 - 99 / RP

Nbr of contacts

004 to 024

Plating

99 = tin
(leadfree)

Packing

RP

Reel packing,
connector with "PickUp Cap"
(Reel packing qty. on request)

Standard:
Connector with PickUp Tape and Reel packing

PCB Surface Mount Layout

Recommended FPC/FFC dimensions

thickness 0.30mm±0.05

Please ask your sales office for details on reel dimension.

SPECIFICATIONS			
Current rating	0.5 A max.	Operating temperature	- 20°C to +85°C
Insulation resistance	500 MΩ min.	Processing temperature	+250°C +0/-5°C for 3sec.
Contact resistance	30 mΩ max.	Contact material <i>(RoHS compliant)</i>	Phosphor Bronze
Withstanding voltage	500 V AC	Contact plating	Tin <i>(leadfree)</i>
		Insulator material <i>(RoHS compliant)</i>	LCP (beige) UL 94 V-0
		Actuator material <i>(RoHS compliant)</i>	PPS (black) UL 94 V-0

Dimensions (mm)											
Contacts	DIM "A"	DIM "B"	Contacts	DIM "A"	DIM "B"	Contacts	DIM "A"	DIM "B"	Contacts	DIM "A"	DIM "B"
002	3.06	6.90	007	8.06	11.90	012	13.06	16.90	017	18.06	21.90
003	4.06	7.90	008	9.06	10.90	013	14.06	17.90	018	19.06	22.90
004	5.06	8.90	009	10.06	13.90	014	15.06	18.90	019	20.06	23.90
005	6.06	9.90	010	11.06	14.90	015	16.06	19.90			
006	7.06	10.90	011	12.06	15.90	016	17.06	20.90			

How to order

FCZ - xxx - VZ100 - 99 / XX

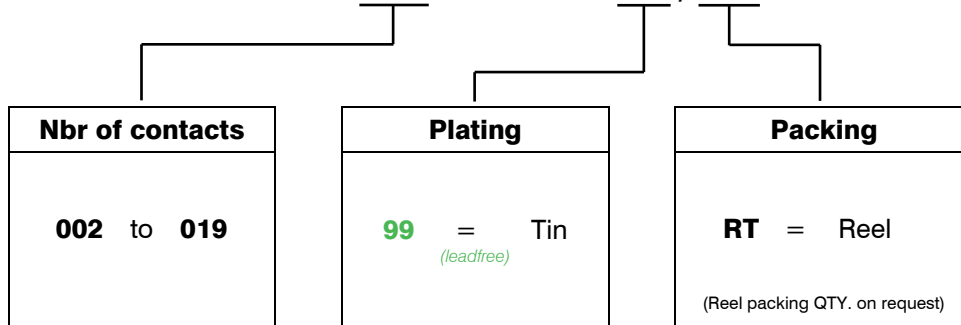

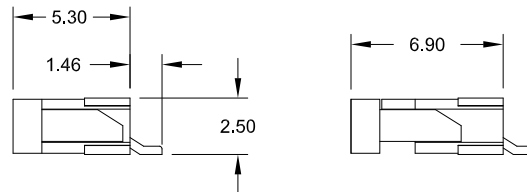
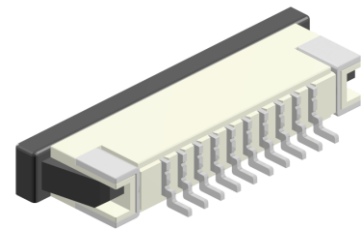
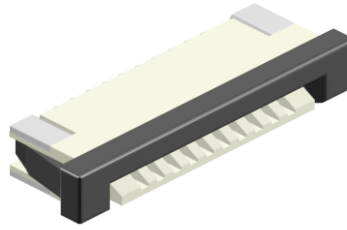
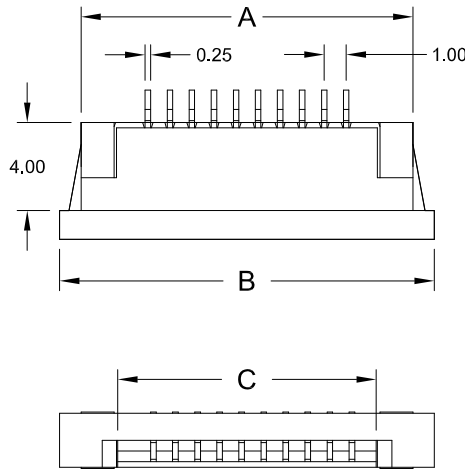

upper contact Style 102

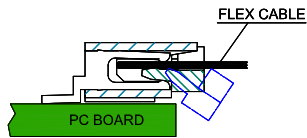

lower contact Style 103

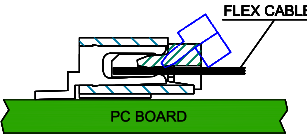

PCB Surface Mount Layout

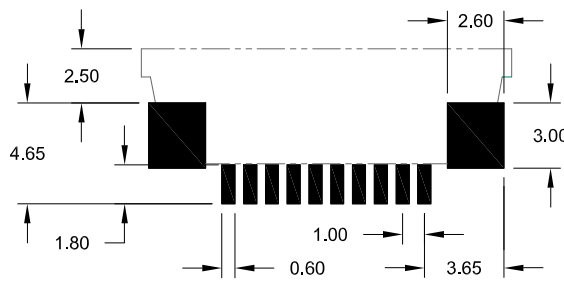

Recommended FPC/FFC dimensions

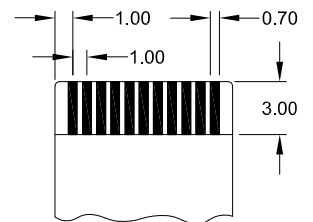

thickness 0.30mm±0.05

SPECIFICATIONS

Current rating	0.5 A max.	Operating temperature	- 20°C to +85°C
Insulation resistance	500 MΩ min.	Processing temperature	+250°C +0/-5°C for 3sec.
Contact resistance	30 mΩ max.	Contact material	Phosphor Bronze (RoHS compliant)
Withstanding voltage	500 V AC	Contact plating	Tin (leadfree)
		Insulator material	LCP (nature) UL 94 V-0 (RoHS compliant)
		Actuator material	LCP (black) UL 94 V-0 (RoHS compliant)

Dimensions (mm)

Contacts	DIM "A"	DIM "B"	DIM "C"	Contacts	DIM "A"	DIM "B"	DIM "C"	Contacts	DIM "A"	DIM "B"	DIM "C"
004	9.05	11.00	5.10	013	18.05	20.00	14.10	022	27.05	29.00	23.10
005	10.05	12.00	6.10	014	19.05	21.00	15.10	023	28.05	30.00	24.10
006	11.05	13.00	7.10	015	20.05	22.00	16.10	024	29.05	31.00	25.10
007	12.05	14.00	8.10	016	21.05	23.00	17.10	025	30.05	32.00	26.10
008	13.05	15.00	9.10	017	22.05	24.00	18.10	026	31.05	33.00	27.10
009	14.05	16.00	10.10	018	23.05	25.00	19.10	027	32.05	34.00	28.10
010	15.05	17.00	11.10	019	24.05	26.00	20.10	028	33.05	35.00	29.10
011	16.05	18.00	12.10	020	25.05	27.00	21.10	029	34.05	36.00	20.10
012	17.05	19.00	13.10	021	26.05	28.00	22.10	030	35.05	37.00	31.10

How to order

FCZ - xxx - H xxx - 99 /R

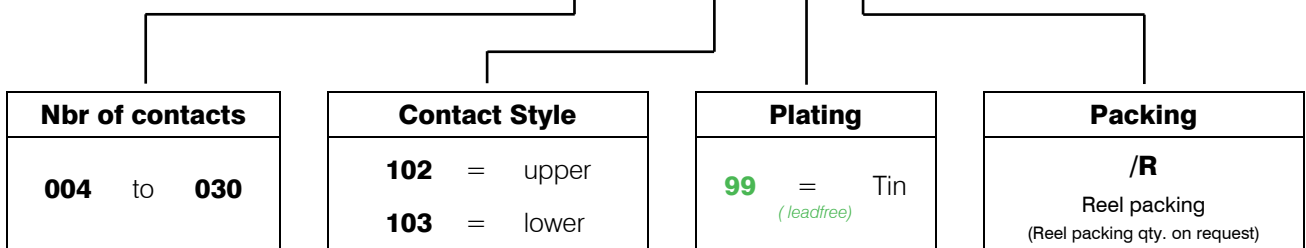

FPC/FFC Connector **ZIF Type**
 - SMT - 1.00mm pitch vertical



Optional:
 Connector with PickUp Cap and Reel packing

PCB Surface Mount Layout

Recommended FPC/FFC dimensions

Please ask your sales office for details on Reel dimension.

01-03-2019

Specifications			
Current rating	0.5 A max.	Operating temperature	- 20°C to +85°C
Insulation resistance	500 MΩ min.	Processing temperature	+250°C +0/-5°C for 3sec.
Contact resistance	30 mΩ max.	Contact material	Phosphor Bronze
Withstanding voltage	500 V AC	Contact plating	Tin (leadfree)
		Insulator material	LCP UL 94 V-0
		Actuator material	LCP UL 94 V-0

Dimensions (mm)											
Contacts	DIM "A"	DIM "B"	Contacts	DIM "A"	DIM "B"	Contacts	DIM "A"	DIM "B"	Contacts	DIM "A"	DIM "B"
003	8.00	4.00	010	15.00	11.20	017	22.00	18.20	024	29.00	25.20
004	9.00	5.00	011	16.00	12.20	018	23.00	19.20	025	30.00	26.20
005	10.00	6.20	012	17.00	13.20	019	24.00	20.20	026	31.00	27.20
006	11.00	7.20	013	18.00	14.20	020	25.00	21.20	027	32.00	28.20
007	12.00	8.20	014	19.00	15.20	021	26.00	22.20	028	33.00	29.20
008	13.00	9.20	015	20.00	16.20	022	27.00	23.20	029	34.00	30.20
009	14.00	10.20	016	21.00	17.20	023	28.00	24.20	030	35.00	31.20

How to order

FCZ - xxx - V115 - 99/RP

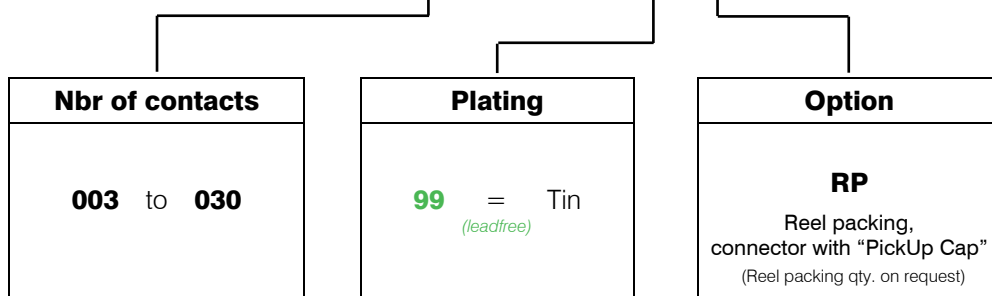

FPC/FFC Connector ZIF Type
- SMT - 1.00mm pitch horizontal

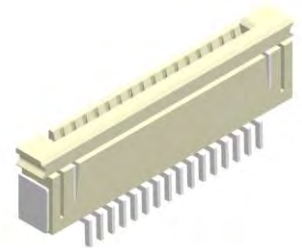
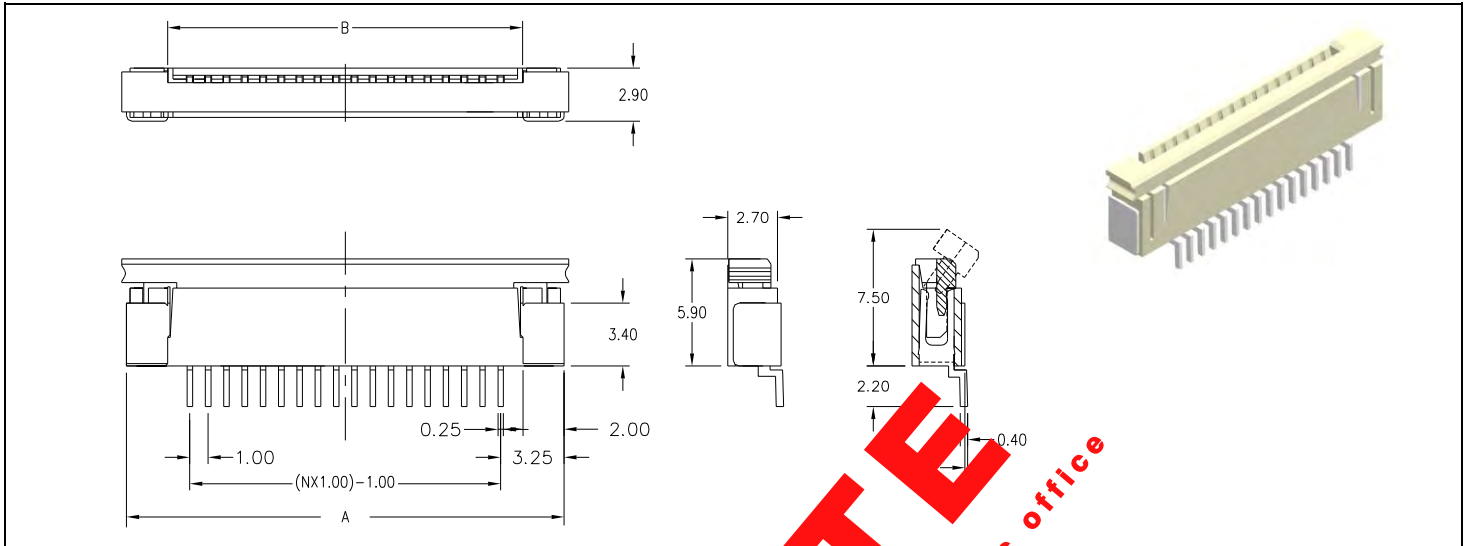

upper contact style 115

lower contact style 116

PCB Surface Mount layout

Recommended FPC/FFC dimensions

thickness 0.30mm ± 0.05

SPECIFICATIONS			
Current rating	0.5 A max.	Operating temperature	- 40°C to +105°C.
Insulator resistance	100 MΩ min.	Processing temperature	+250°C +0/-5°C for 3sec.
Contact resistance	20 mΩ max.	Contact material	Phosphor Bronze (RoHS compliant)
Withstanding voltage	500 V AC/1 Min.	Contact plating	Tin (leadfree)
		Insulator material	LCP UL 94 V-0 (RoHS compliant)
		Actuator material	PPA UL 94 V-0 (RoHS compliant)

Dimensions (mm)											
Contacts	DIM "A"	DIM "B"	Contacts	DIM "A"	DIM "B"	Contacts	DIM "A"	DIM "B"	Contacts	DIM "A"	DIM "B"
003	8.50	4.20	011	16.50	12.20	019	24.50	20.20	027	32.50	28.20
004	9.50	5.20	012	17.50	13.20	020	25.50	21.20	028	33.50	29.20
005	10.50	6.20	013	18.50	14.20	021	26.50	22.20	029	34.50	30.20
006	11.50	7.20	014	19.50	15.20	022	27.50	23.20	030	35.50	31.20
007	12.50	8.20	015	20.50	16.20	023	28.50	24.20	031	36.50	32.20
008	13.50	9.20	016	21.50	17.20	024	29.50	25.20	032	37.50	33.20
009	14.50	10.20	017	22.50	18.20	025	30.50	26.20			
010	15.50	11.20	018	23.50	19.20	026	31.50	27.20			

How to order

FCZ - xxx - H xxx - 99 / X

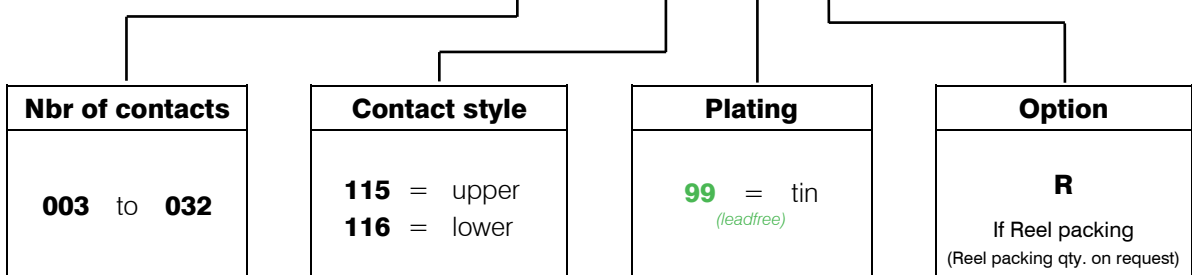

FPC/FFC Connector ZIF Type
- THT - 1.00mm pitch vertical

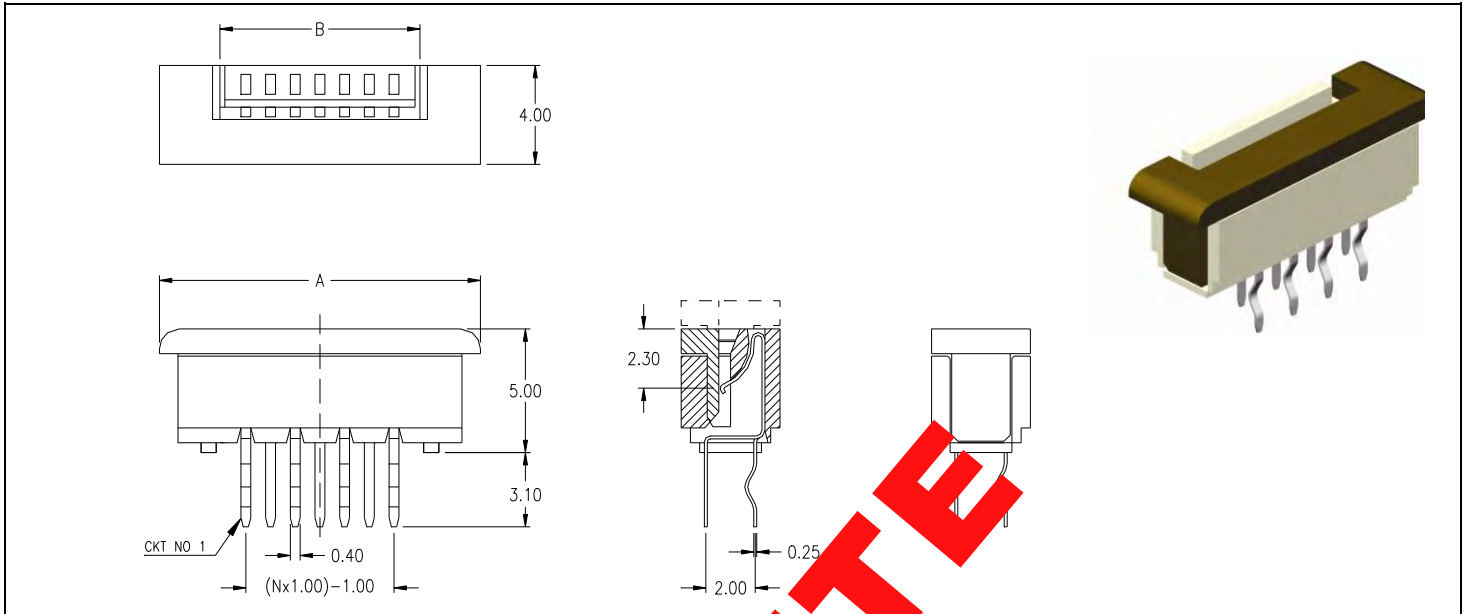

SPECIFICATIONS			
Current rating	0.4 A max.	Operating temperature	- 55°C to +85°C
Insulator resistance	50 MΩ min.	Contact material (RoHS compliant)	Phosphor Bronze
Contact resistance	30 mΩ max.	Contact plating	Tin (leadfree)
Withstanding voltage	250 V AC/1 Min.	Insulator material (RoHS compliant)	Nylon UL 94 V-0

Dimensions (mm)											
Contacts	DIM "A"	DIM "B"	Contacts	DIM "A"	DIM "B"	Contacts	DIM "A"	DIM "B"	Contacts	DIM "A"	DIM "B"
004	10.00	5.20	012	18.00	13.20	020	26.00	21.20	028	34.00	29.20
005	11.00	6.20	013	19.00	14.20	021	27.00	22.20	029	35.00	30.20
006	12.00	7.20	014	20.00	15.20	022	28.00	23.20	030	36.00	31.20
007	13.00	8.20	015	21.00	16.20	023	29.00	24.20	031	37.00	32.20
008	14.00	9.20	016	22.00	17.20	024	30.00	25.20	032	38.00	33.20
009	15.00	10.20	017	23.00	18.20	025	31.00	26.20			
010	16.00	11.20	018	24.00	19.20	026	32.00	27.20			
011	17.00	12.20	019	25.00	20.20	027	33.00	28.20			

How to order

FCZ - xxx - SX100 - 99

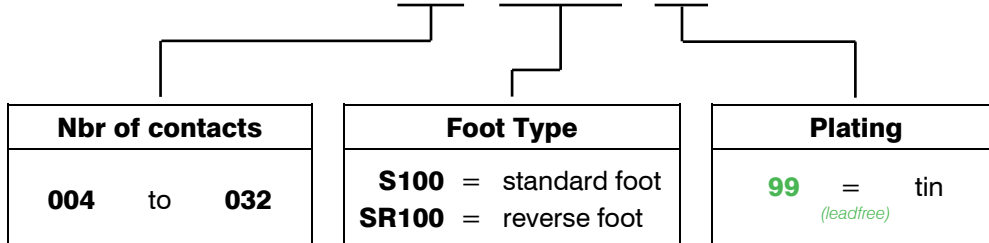

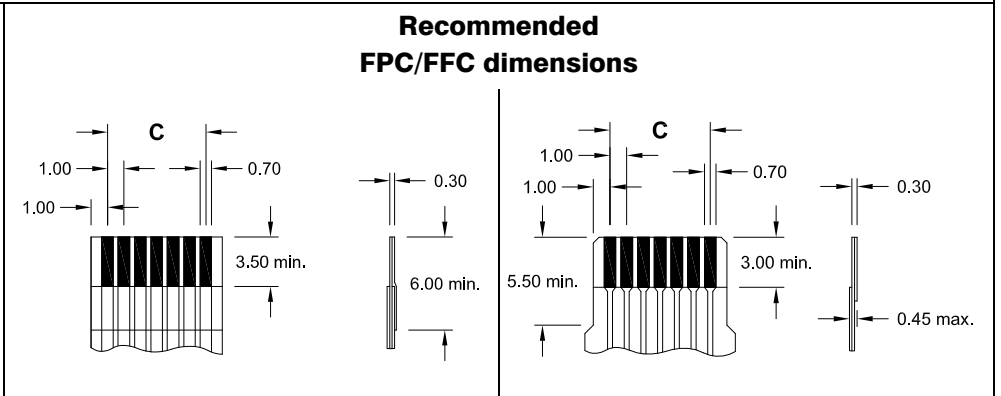
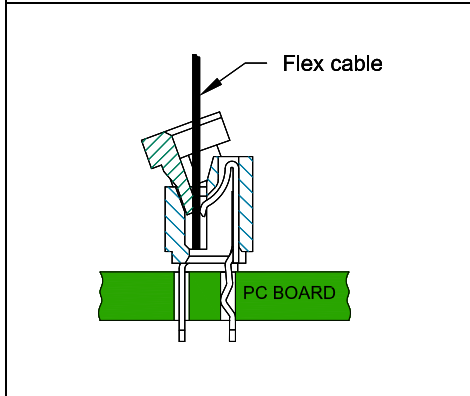
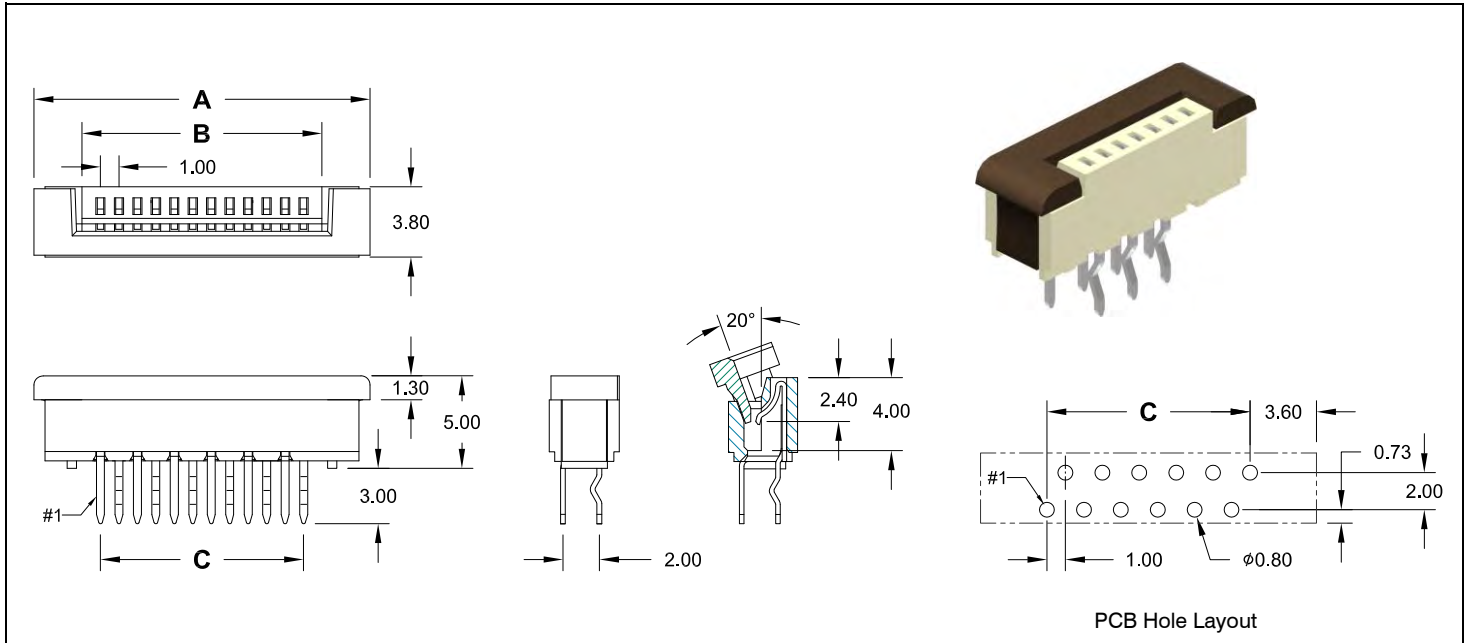

Specifications

Current rating	0.5 A max.	Operating temperature	-20°C to +85°C
Insulation resistance	500 MΩ min.	Contact material	(RoHS compliant) Phosphor Bronze
Contact resistance	30 mΩ max.	Contact plating	Tin (leadfree)
Withstanding voltage	500 V AC	Insulator material	(RoHS compliant) PA6T (natural) UL 94 V-0
		Actuator material	(RoHS compliant) PA6T (brown) UL 94 V-0

Dimensions (mm)

Contacts	DIM "A"	DIM "B"	DIM "C"	Contacts	DIM "A"	DIM "B"	DIM "C"	Contacts	DIM "A"	DIM "B"	DIM "C"	Contacts	DIM "A"	DIM "B"	DIM "C"
004	10.20	5.10	3.00	012	18.20	13.10	11.00	020	26.20	21.10	19.00	028	34.20	29.10	27.00
005	11.20	6.10	4.00	013	19.20	14.10	12.00	021	27.20	22.10	20.00	029	35.20	30.10	28.00
006	12.20	7.10	5.00	014	20.20	15.10	13.00	022	28.20	23.10	21.00	030	36.20	31.10	29.00
007	13.20	8.10	6.00	015	21.20	16.10	14.00	023	29.20	24.10	22.00	031	37.20	32.10	30.00
008	14.20	9.10	7.00	016	22.20	17.10	15.00	024	30.20	25.10	23.00	032	38.20	33.10	31.00
009	15.20	10.10	8.00	017	23.20	18.10	16.00	025	31.20	26.10	24.00				
010	16.20	11.10	9.00	018	24.20	19.10	17.00	026	32.20	27.10	25.00				
011	17.20	12.10	10.00	019	25.20	20.10	18.00	027	33.20	28.10	26.00				

How to order

FCZ - xxx - SL100 - 99

Nbr of contacts

004	to	032
-----	----	-----

Plating

99	=	Tin
		(leadfree)

FPC/FFC Connector ZIF Type
 - THT - 1.00mm pitch right angle

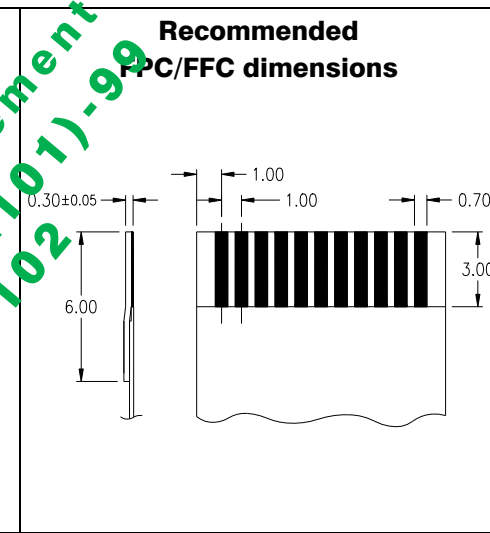
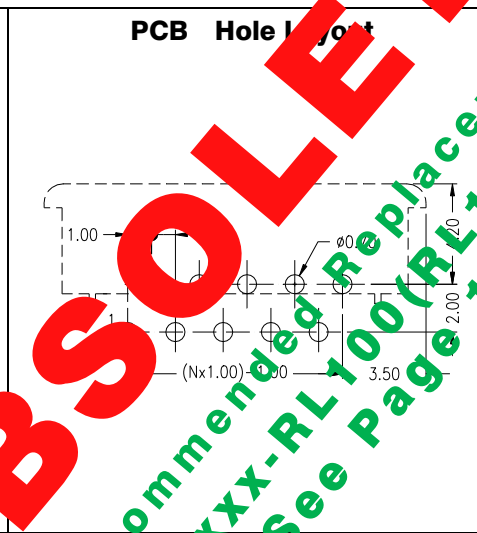
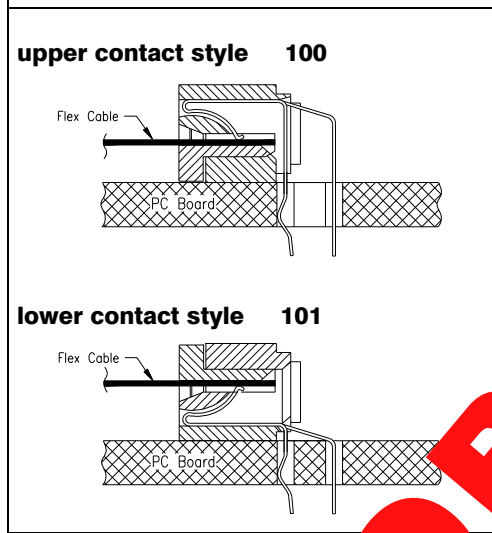
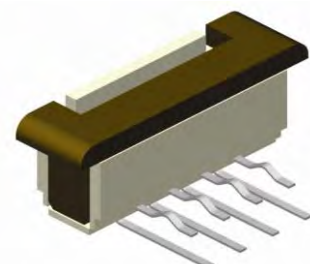
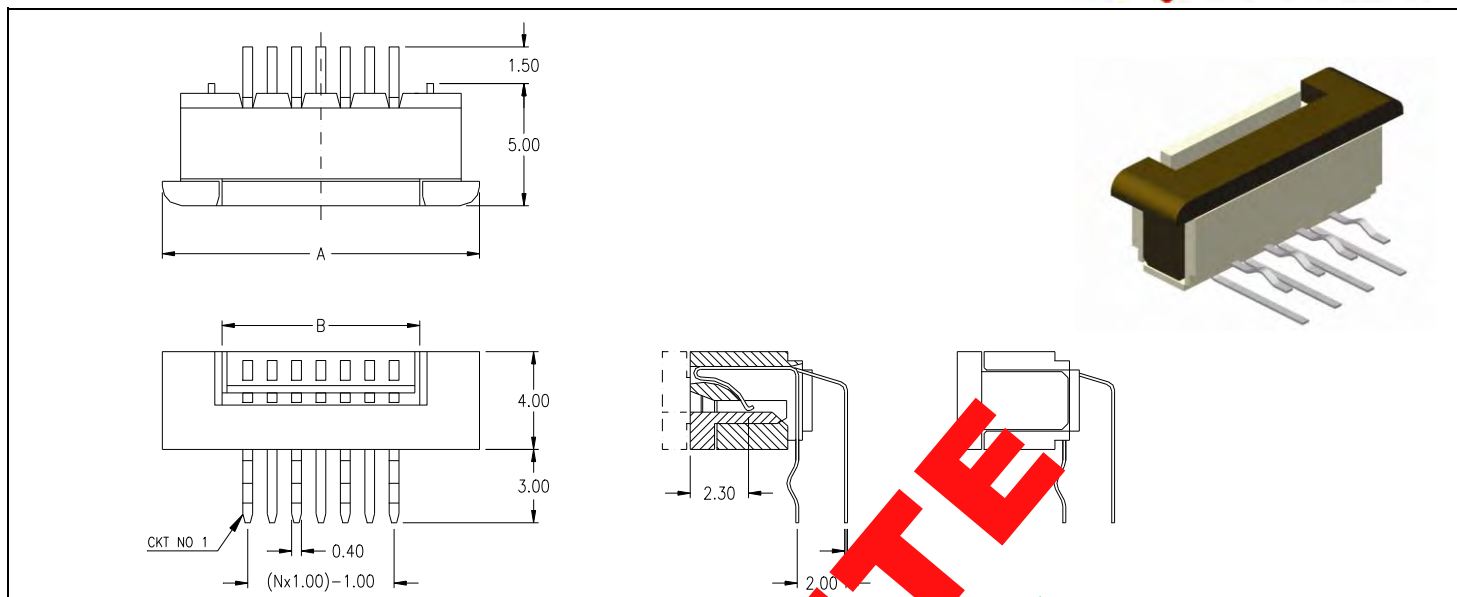

OBSOLETE

Recommended Replacement
 FCZ-xxx-RL100(RL101)-99
 See Page 102

SPECIFICATIONS			
Current rating	0.4 A max.	Operating temperature	- 55°C to +85°C
Insulator resistance	50 MΩ min.	Contact material	(RoHS compliant) Phosphor Bronze
Contact resistance	30 mΩ max.	Contact plating	Tin (leadfree)
Withstanding voltage	250 V AC/1 Min.	Insulator material	(RoHS compliant) Nylon UL 94 V-0

Dimensions (mm)											
Contacts	DIM "A"	DIM "B"	Contacts	DIM "A"	DIM "B"	Contacts	DIM "A"	DIM "B"	Contacts	DIM "A"	DIM "B"
004	10.00	5.20	012	18.00	13.20	020	26.00	21.20	028	34.00	29.20
005	11.00	6.20	013	19.00	14.20	021	27.00	22.20	029	35.00	30.20
006	12.00	7.20	014	20.00	15.20	022	28.00	23.20	030	36.00	31.20
007	13.00	8.20	015	21.00	16.20	023	29.00	24.20	031	37.00	32.20
008	14.00	9.20	016	22.00	17.20	024	30.00	25.20	032	38.00	33.20
009	15.00	10.20	017	23.00	18.20	025	31.00	26.20			
010	16.00	11.20	018	24.00	19.20	026	32.00	27.20			
011	17.00	12.20	019	25.00	20.20	027	33.00	28.20			

How to order

FCZ - xxx - R xxx - 99

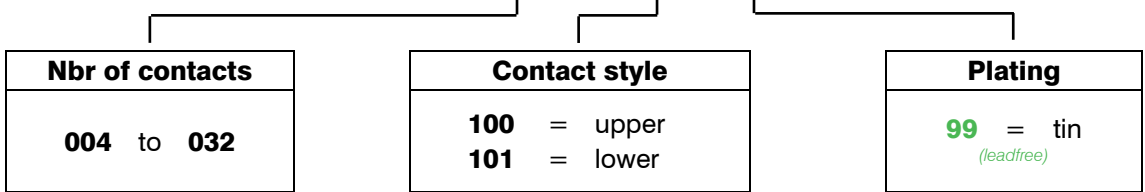

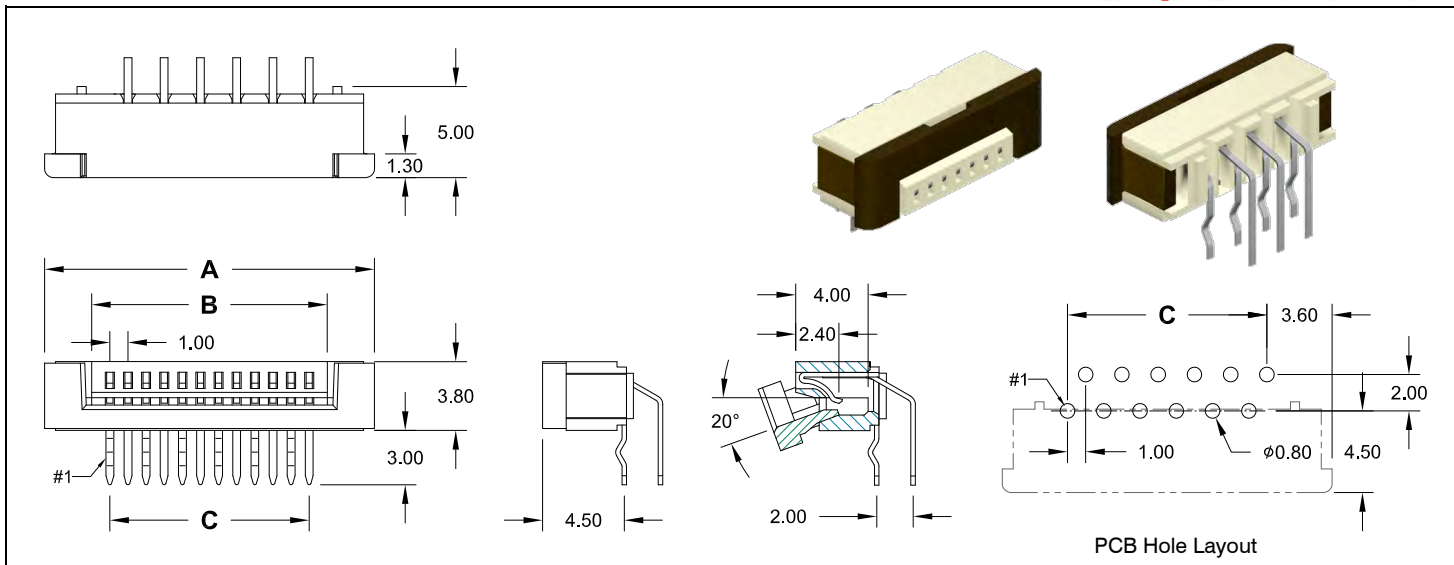

upper contact Style 100

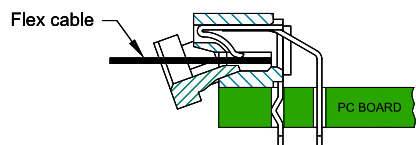

lower contact Style 101

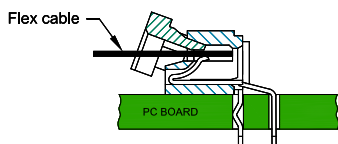

Recommended FPC/FFC dimensions

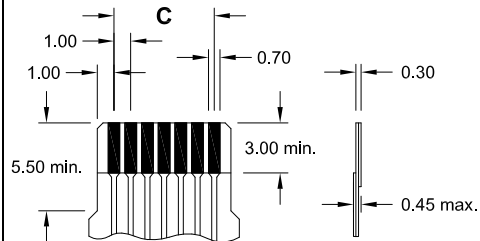
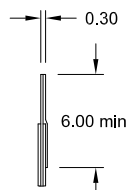
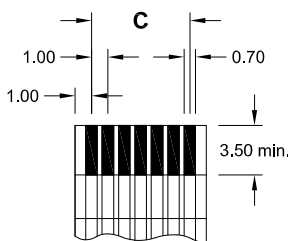

Specifications

Current rating
Insulation resistance
Contact resistance
Withstanding voltage

0.5 A max.
500 MΩ min.
30 mΩ max.
500 V AC

Operating temperature -20°C to +85°C
Contact material (RoHS compliant) Phosphor Bronze
Contact plating Tin (leadfree)
Insulator material (RoHS compliant) PA6T (nature) UL 94 V-0
Actuator material (RoHS compliant) PA6T (brown) UL 94 V-0

Dimensions (mm)

Contacts	DIM "A"	DIM "B"	DIM "C"	Contacts	DIM "A"	DIM "B"	DIM "C"	Contacts	DIM "A"	DIM "B"	DIM "C"	Contacts	DIM "A"	DIM "B"	DIM "C"
004	10.20	5.10	3.00	012	18.20	13.10	11.00	020	26.20	21.10	19.00	028	34.20	29.10	27.00
005	11.20	6.10	4.00	013	19.20	14.10	12.00	021	27.20	22.10	20.00	029	35.20	30.10	28.00
006	12.20	7.10	5.00	014	20.20	15.10	13.00	022	28.20	23.10	21.00	030	36.20	31.10	29.00
007	13.20	8.10	6.00	015	21.20	16.10	14.00	023	29.20	24.10	22.00	031	37.20	32.10	30.00
008	14.20	9.10	7.00	016	22.20	17.10	15.00	024	30.20	25.10	23.00	032	38.20	33.10	31.00
009	15.20	10.10	8.00	017	23.20	18.10	16.00	025	31.20	26.10	24.00				
010	16.20	11.10	9.00	018	24.20	19.10	17.00	026	32.20	27.10	25.00				
011	17.20	12.10	10.00	019	25.20	20.10	18.00	027	33.20	28.10	26.00				

How to order

FCZ - xxx - RL xxx - 99

Nbr of contacts
004 to 032

Contact Style
100 = upper
101 = lower

Plating
99 = Tin (leadfree)

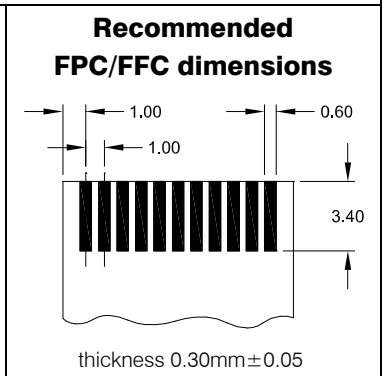
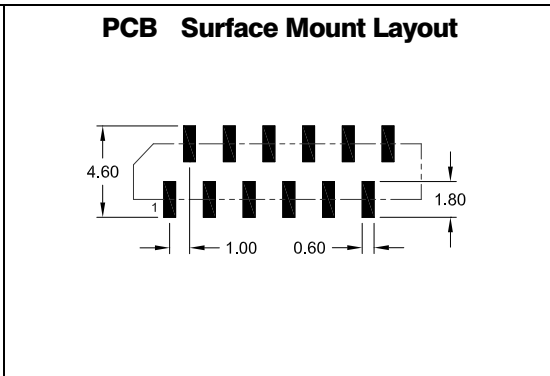
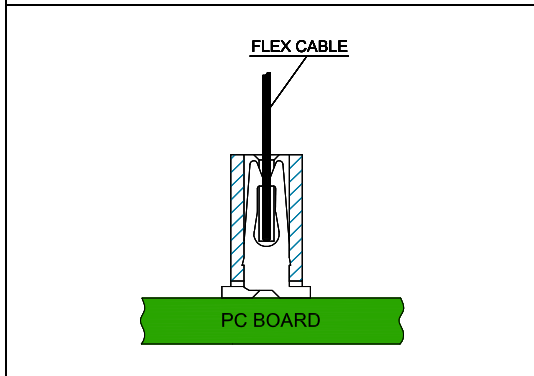
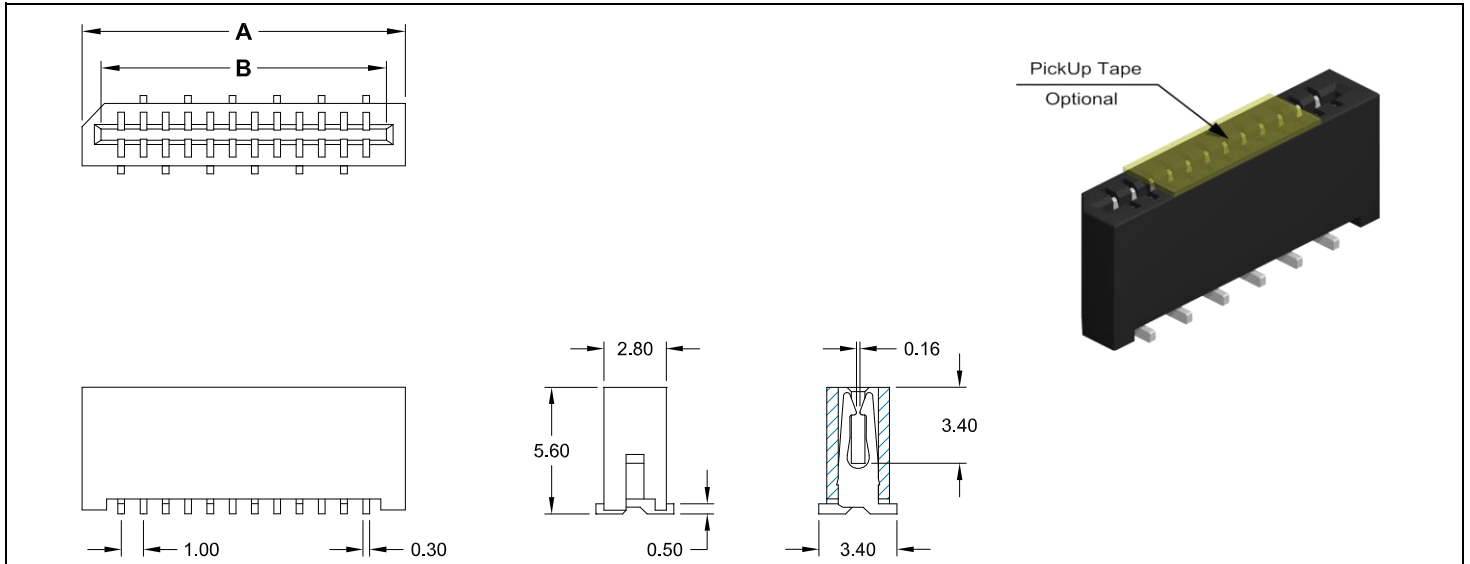

Specifications

Current rating	0.5 A max.	Operating temperature	- 20°C to +85°C
Insulation resistance	500 MΩ min.	Processing temperature	+250°C +0/-5°C for 3sec.
Contact resistance	30 mΩ max.	Contact material	Phosphor Bronze (RoHS compliant)
Withstanding voltage	500 V AC	Contact plating	Tin (leadfree)
		Insulator material	PA9T (black) UL 94 V-0 (RoHS compliant)

Dimensions (mm)

Contacts	DIM "A"	DIM "B"	Contacts	DIM "A"	DIM "B"	Contacts	DIM "A"	DIM "B"	Contacts	DIM "A"	DIM "B"
003	6.00	4.10	012	15.00	13.10	021	24.00	22.10	030	33.00	31.10
004	7.00	5.10	013	16.00	14.10	022	25.00	23.10			
005	8.00	6.10	014	17.00	15.10	023	26.00	24.10			
006	9.00	7.10	015	18.00	16.10	024	27.00	25.10			
007	10.00	8.10	016	19.00	17.10	025	28.00	26.10			
008	11.00	9.10	017	20.00	18.10	026	29.00	27.10			
009	12.00	10.10	018	21.00	19.10	027	30.00	28.10			
010	13.00	11.10	019	22.00	20.10	028	31.00	29.10			
011	14.00	12.10	020	23.00	21.10	029	32.00	30.10			

How to order

FCL - xxx - V100 - 99 /XX

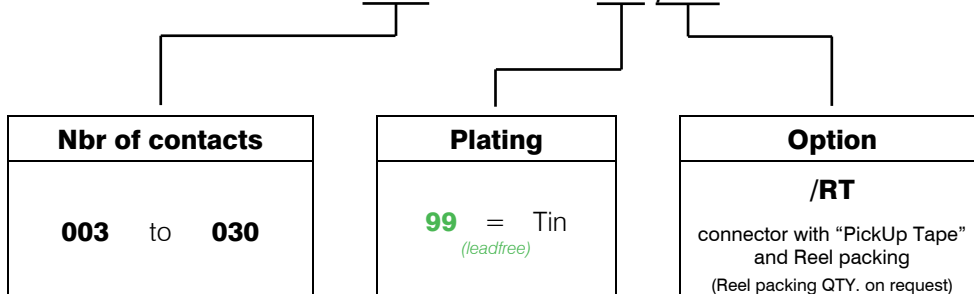

FPC/FFC Connector **LIF Type**
 - SMT - 1.00mm pitch horizontal

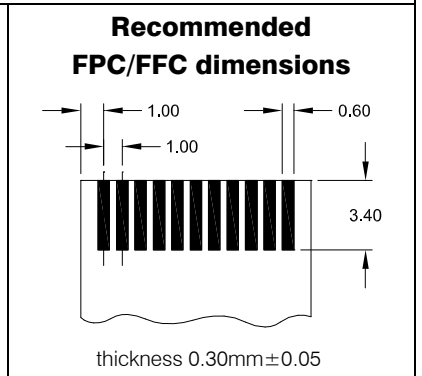
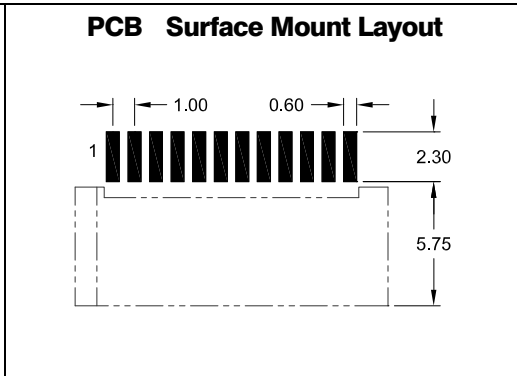
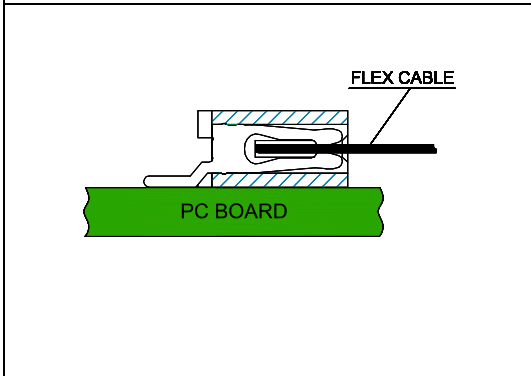
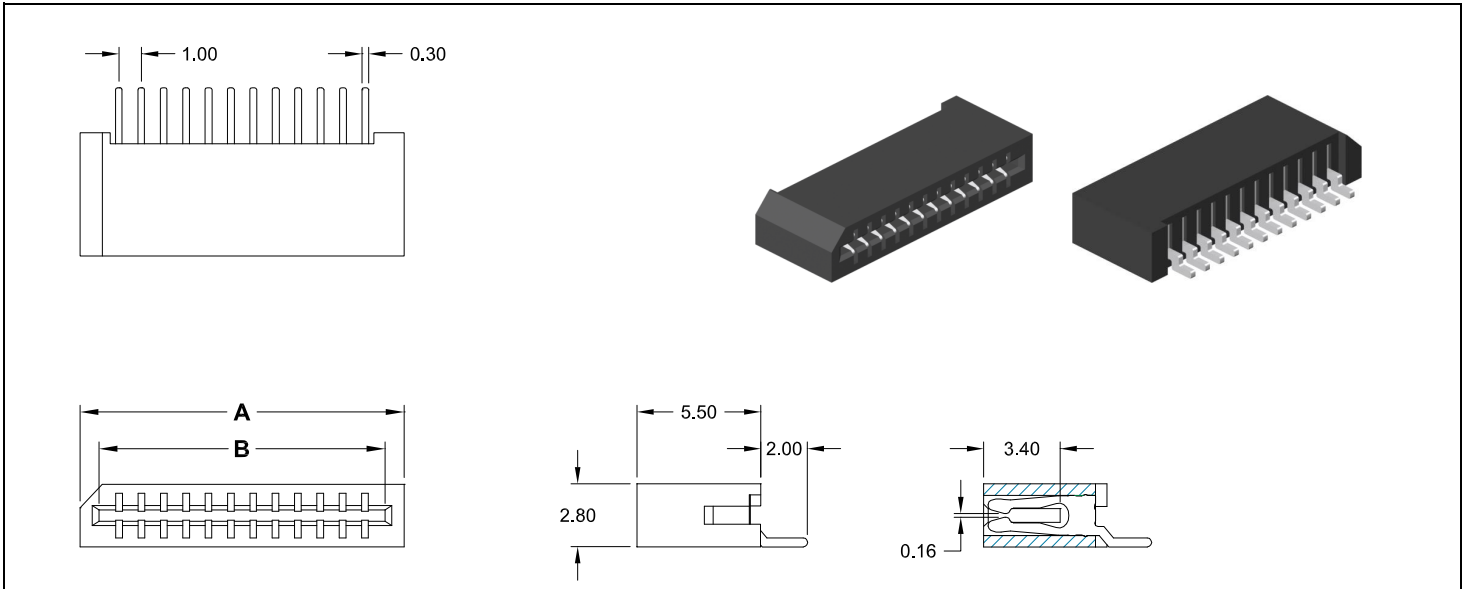

Specifications

Current rating	0.5 A max.	Operating temperature	- 20°C to +85°C
Insulation resistance	500 MΩ min.	Processing temperature	+250°C +0/-5°C for 3sec.
Contact resistance	30 mΩ max.	Contact material	Phosphor Bronze (RoHS compliant)
Withstanding voltage	500 V AC	Contact plating	Tin (leadfree)
		Insulator material	PA9T (black) UL 94 V-0 (RoHS compliant)

Dimensions (mm)

Contacts	DIM "A"	DIM "B"	Contacts	DIM "A"	DIM "B"	Contacts	DIM "A"	DIM "B"	Contacts	DIM "A"	DIM "B"
003	6.00	4.10	012	15.00	13.10	021	24.00	22.10	030	33.00	31.10
004	7.00	5.10	013	16.00	14.10	022	25.00	23.10			
005	8.00	6.10	014	17.00	15.10	023	26.00	24.10			
006	9.00	7.10	015	18.00	16.10	024	27.00	25.10			
007	10.00	8.10	016	19.00	17.10	025	28.00	26.10			
008	11.00	9.10	017	20.00	18.10	026	29.00	27.10			
009	12.00	10.10	018	21.00	19.10	027	30.00	28.10			
010	13.00	11.10	019	22.00	20.10	028	31.00	29.10			
011	14.00	12.10	020	23.00	21.10	029	32.00	30.10			

How to order

FCL - xxx - H100 - 99 /X

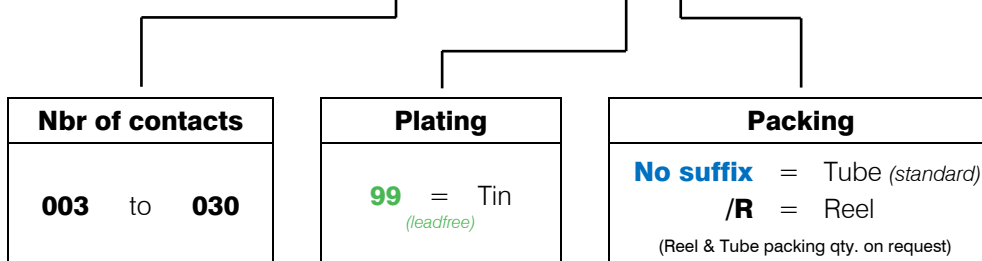

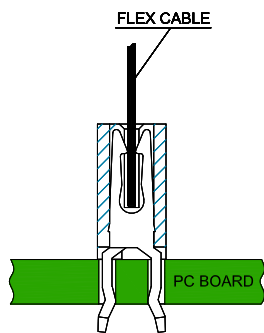
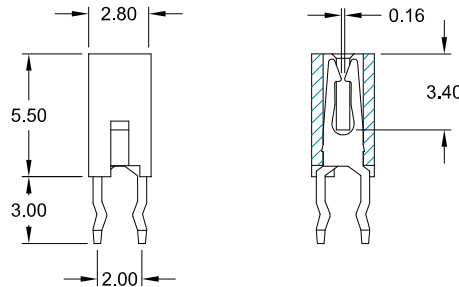
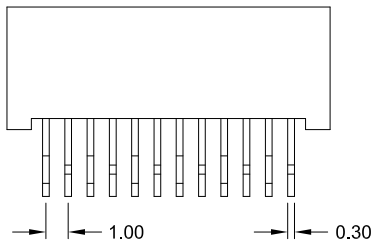
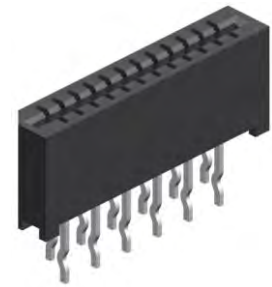
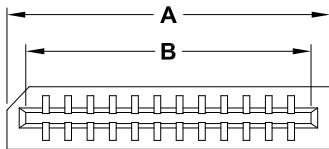

PCB Hole Layout

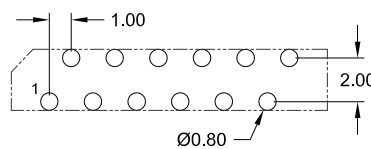

Recommended FPC/FFC dimensions

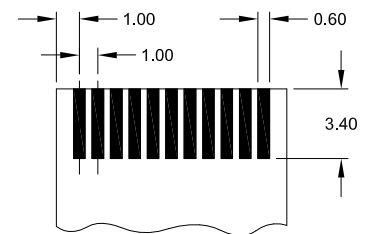

thickness 0.30mm±0.05

Specifications

Current rating	0.5 A max.	Operating temperature	- 20°C to +85°C
Insulation resistance	500 MΩ min.	Contact material	Phosphor Bronze (RoHS compliant)
Contact resistance	30 mΩ max.	Contact plating	Tin (leadfree)
Withstanding voltage	500 V AC	Insulator material	PA9T (black) UL 94 V-0 (RoHS compliant)

Dimensions (mm)

Contacts	DIM "A"	DIM "B"	Contacts	DIM "A"	DIM "B"	Contacts	DIM "A"	DIM "B"	Contacts	DIM "A"	DIM "B"
003	6.00	4.10	012	15.00	13.10	021	24.00	22.10	030	33.00	31.10
004	7.00	5.10	013	16.00	14.10	022	25.00	23.10	031	34.00	32.10
005	8.00	6.10	014	17.00	15.10	023	26.00	24.10	032	35.00	33.10
006	9.00	7.10	015	18.00	16.10	024	27.00	25.10			
007	10.00	8.10	016	19.00	17.10	025	28.00	26.10			
008	11.00	9.10	017	20.00	18.10	026	29.00	27.10			
009	12.00	10.10	018	21.00	19.10	027	30.00	28.10			
010	13.00	11.10	019	22.00	20.10	028	31.00	29.10			
011	14.00	12.10	020	23.00	21.10	029	32.00	30.10			

How to order

FCL - xxx - S100 - 99

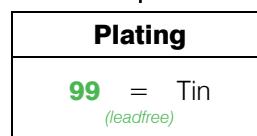

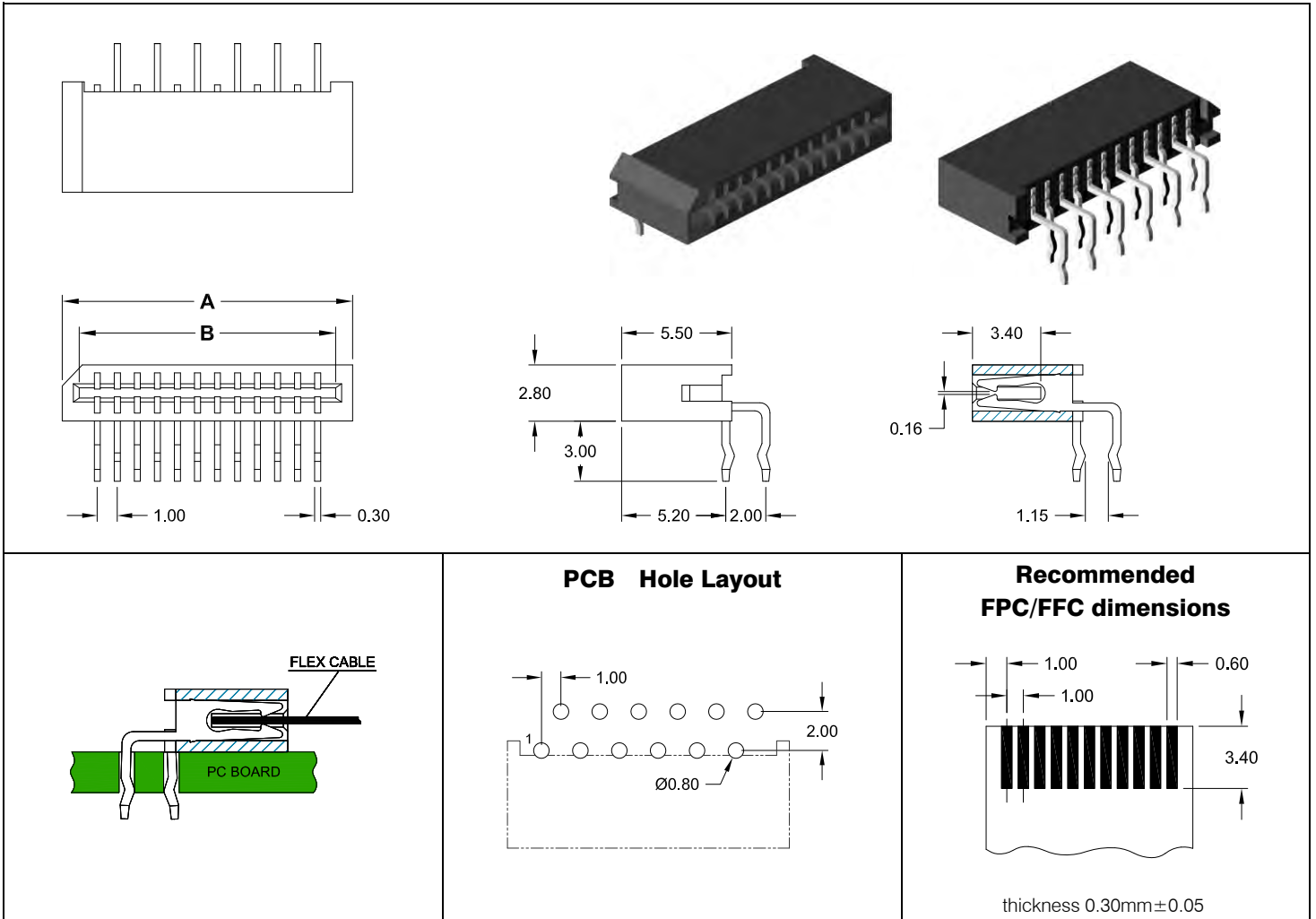

Specifications			
Current rating	0.5 A max.	Operating temperature	- 20°C to +85°C
Insulation resistance	500 MΩ min.	Contact material	Phosphor Bronze (RoHS compliant)
Contact resistance	30 mΩ max.	Contact plating	Tin (leadfree)
Withstanding voltage	500 V AC	Insulator material	PA9T (black) UL 94 V-0 (RoHS compliant)

Dimensions (mm)											
Contacts	DIM "A"	DIM "B"	Contacts	DIM "A"	DIM "B"	Contacts	DIM "A"	DIM "B"	Contacts	DIM "A"	DIM "B"
003	6.00	4.10	012	15.00	13.10	021	24.00	22.10	030	33.00	31.10
004	7.00	5.10	013	16.00	14.10	022	25.00	23.10			
005	8.00	6.10	014	17.00	15.10	023	26.00	24.10			
006	9.00	7.10	015	18.00	16.10	024	27.00	25.10			
007	10.00	8.10	016	19.00	17.10	025	28.00	26.10			
008	11.00	9.10	017	20.00	18.10	026	29.00	27.10			
009	12.00	10.10	018	21.00	19.10	027	30.00	28.10			
010	13.00	11.10	019	22.00	20.10	028	31.00	29.10			
011	14.00	12.10	020	23.00	21.10	029	32.00	30.10			

How to order

FCL - xxx - R100 - 99

Nbr of contacts
003 to 030

Plating
99 = Tin (leadfree)

FPC/FFC Connector **LIF Type**
 - SMT - 1.25mm pitch horizontal

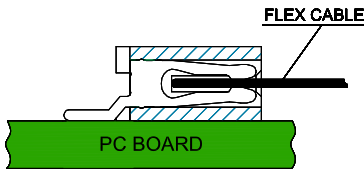
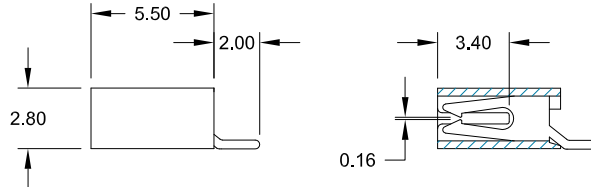
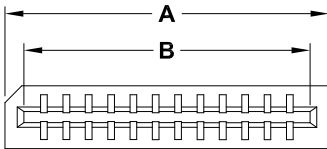
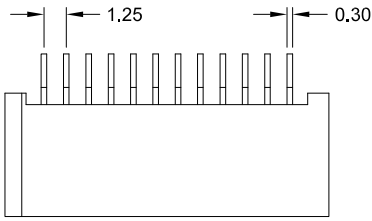

PCB Surface Mount Layout

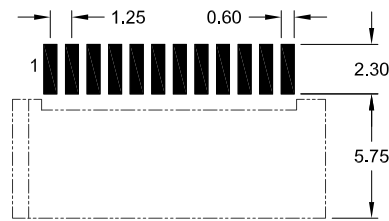

Recommended FPC/FFC dimensions

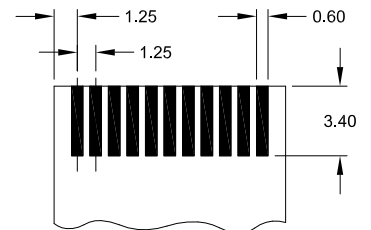

thickness 0.30mm±0.05

Specifications

Current rating	0.5 A max.	Operating temperature	- 20°C to +85°C
Insulation resistance	500 MΩ min.	Processing temperature	+250°C +0/-5°C for 3sec.
Contact resistance	30 mΩ max.	Contact material	Phosphor Bronze (RoHS compliant)
Withstanding voltage	500 V AC	Contact plating	Tin (leadfree)
		Insulator material	PA9T (black) UL 94 V-0 (RoHS compliant)

Dimensions (mm)

Contacts	DIM "A"	DIM "B"	Contacts	DIM "A"	DIM "B"	Contacts	DIM "A"	DIM "B"	Contacts	DIM "A"	DIM "B"
003	7.15	5.10	012	18.40	16.35	021	29.65	27.60	030	40.90	38.85
004	8.40	6.35	013	19.65	17.60	022	30.90	28.85			
005	9.65	7.60	014	20.90	18.85	023	32.15	30.10			
006	10.90	8.85	015	22.15	20.10	024	33.40	31.35			
007	12.15	10.10	016	23.40	21.35	025	34.65	32.60			
008	13.40	11.35	017	24.65	22.60	026	35.90	33.85			
009	14.65	12.60	018	25.90	23.85	027	37.15	35.10			
010	15.90	13.85	019	27.15	25.10	028	38.40	36.35			
011	17.50	15.10	020	28.40	26.35	029	39.65	37.60			

How to order

FCL - xxx - H125 - 99 /X

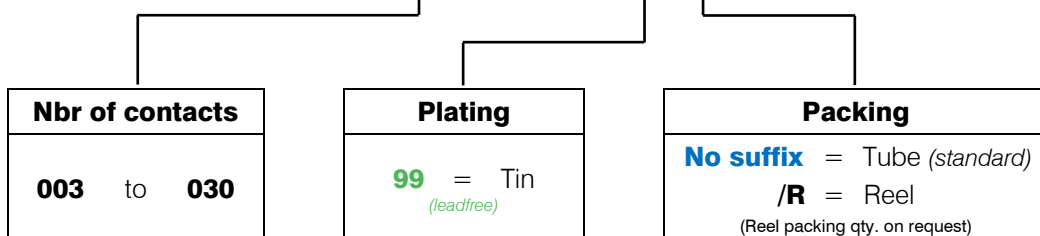

FPC/FFC Connector **LIF Type**
 - THT - 1.25mm pitch vertical

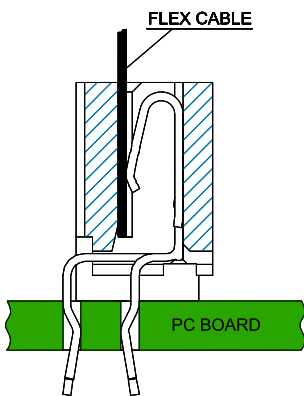
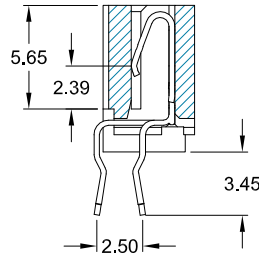
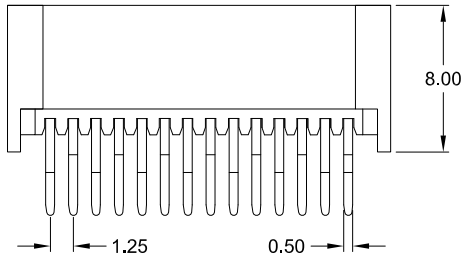
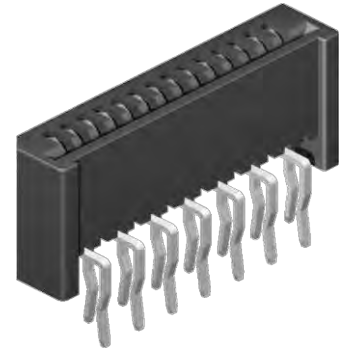
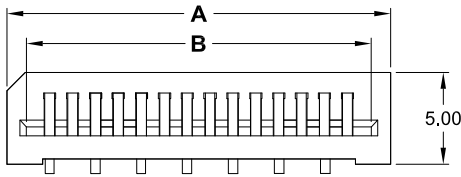

PCB Hole Layout

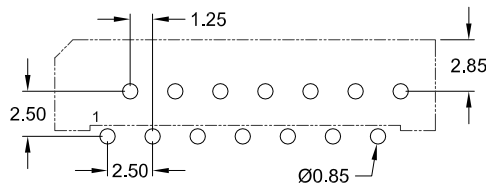

Recommended FPC/FFC dimensions

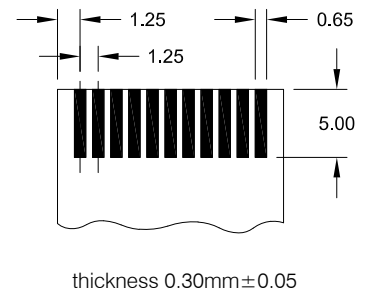

Specifications

Current rating	0.5 A max.	Operating temperature	- 20°C to +85°C
Insulation resistance	500 MΩ min.	Contact material	Phosphor Bronze (RoHS compliant)
Contact resistance	30 mΩ max.	Contact plating	Tin (leadfree)
Withstanding voltage	500 V AC	Insulator material	PA9T (black) UL 94 V-0 (RoHS compliant)

Dimensions (mm)

Contacts	DIM "A"	DIM "B"	Contacts	DIM "A"	DIM "B"	Contacts	DIM "A"	DIM "B"	Contacts	DIM "A"	DIM "B"
004	8.40	6.30	013	19.65	17.55	022	30.90	28.80	031	42.15	40.05
005	9.65	7.55	014	20.90	18.80	023	32.15	30.05	032	43.40	41.30
006	10.90	8.80	015	22.15	20.05	024	33.40	31.30	033	44.65	42.55
007	12.15	10.05	016	23.40	21.30	025	34.65	32.55	034	45.90	43.80
008	13.40	11.30	017	24.65	22.55	026	35.90	33.80	035	47.15	45.05
009	14.65	12.55	018	25.90	23.80	027	37.15	35.05			
010	15.90	13.80	019	27.15	25.05	028	38.40	36.30			
011	17.50	15.05	020	28.40	26.30	029	39.65	37.55			
012	18.40	16.30	021	29.65	27.55	030	40.90	38.80			

How to order

FCL - xxx - S125 - 99

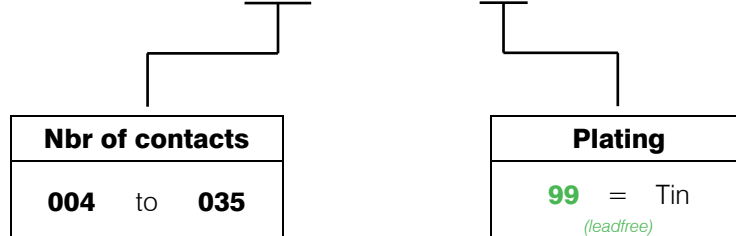

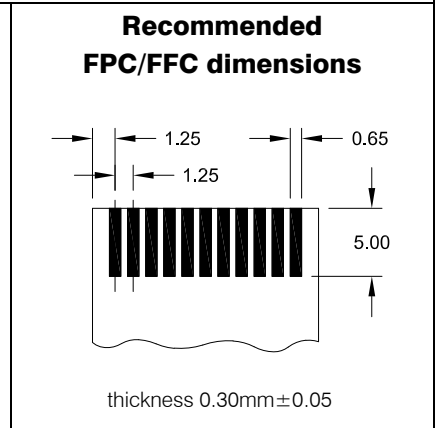
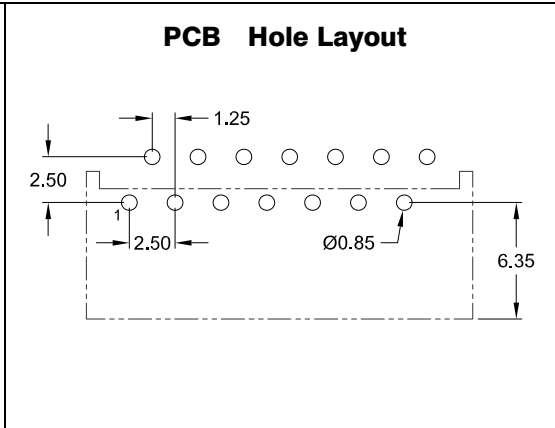
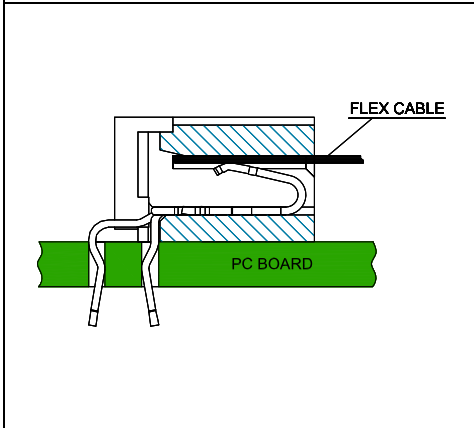
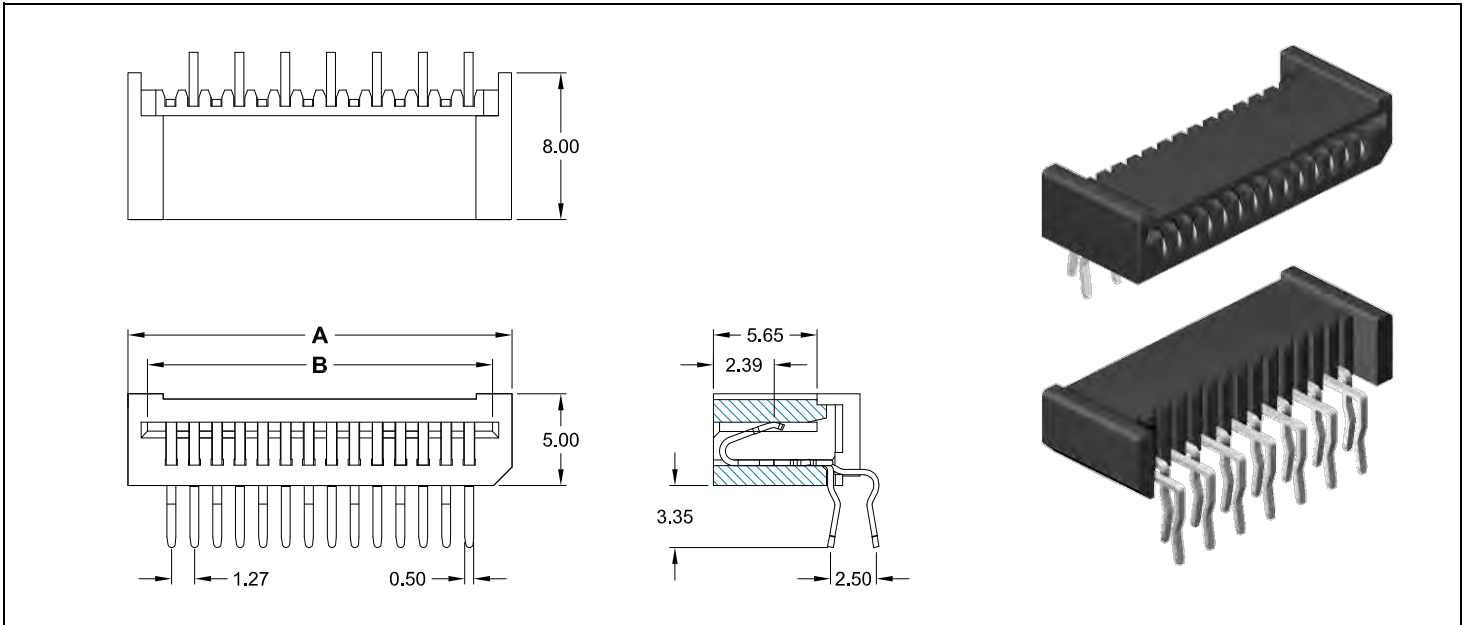

Specifications

Current rating	0.5 A max.	Operating temperature	- 20°C to +85°C
Insulation resistance	500 MΩ min.	Contact material	Phosphor Bronze (RoHS compliant)
Contact resistance	30 mΩ max.	Contact plating	Tin (leadfree)
Withstanding voltage	500 V AC	Insulator material	PA9T (black) UL 94 V-0 (RoHS compliant)

Dimensions (mm)

Contacts	DIM "A"	DIM "B"	Contacts	DIM "A"	DIM "B"	Contacts	DIM "A"	DIM "B"	Contacts	DIM "A"	DIM "B"
004	8.40	6.30	013	19.65	17.55	022	30.90	28.80	031	42.15	40.05
005	9.65	7.55	014	20.90	18.80	023	32.15	30.05	032	43.40	41.30
006	10.90	8.80	015	22.15	20.05	024	33.40	31.30	033	44.65	42.55
007	12.15	10.05	016	23.40	21.30	025	34.65	32.55	034	45.90	43.80
008	13.40	11.30	017	24.65	22.55	026	35.90	33.80	035	47.15	45.05
009	14.65	12.55	018	25.90	23.80	027	37.15	35.05			
010	15.90	13.80	019	27.15	25.05	028	38.40	36.30			
011	17.50	15.05	020	28.40	26.30	029	39.65	37.55			
012	18.40	16.30	021	29.65	27.55	030	40.90	38.80			

How to order

FCL - xxx - R125 - 99

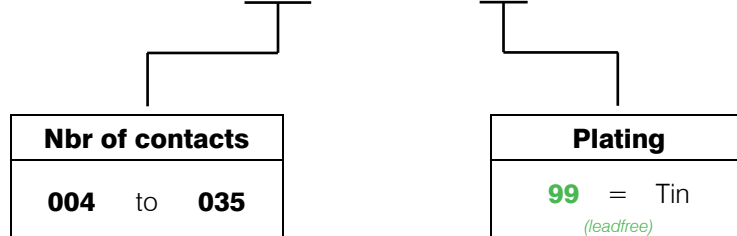

FPC/FFC Connector ZIF Type
 - THT - 1.25mm pitch straight & right angle

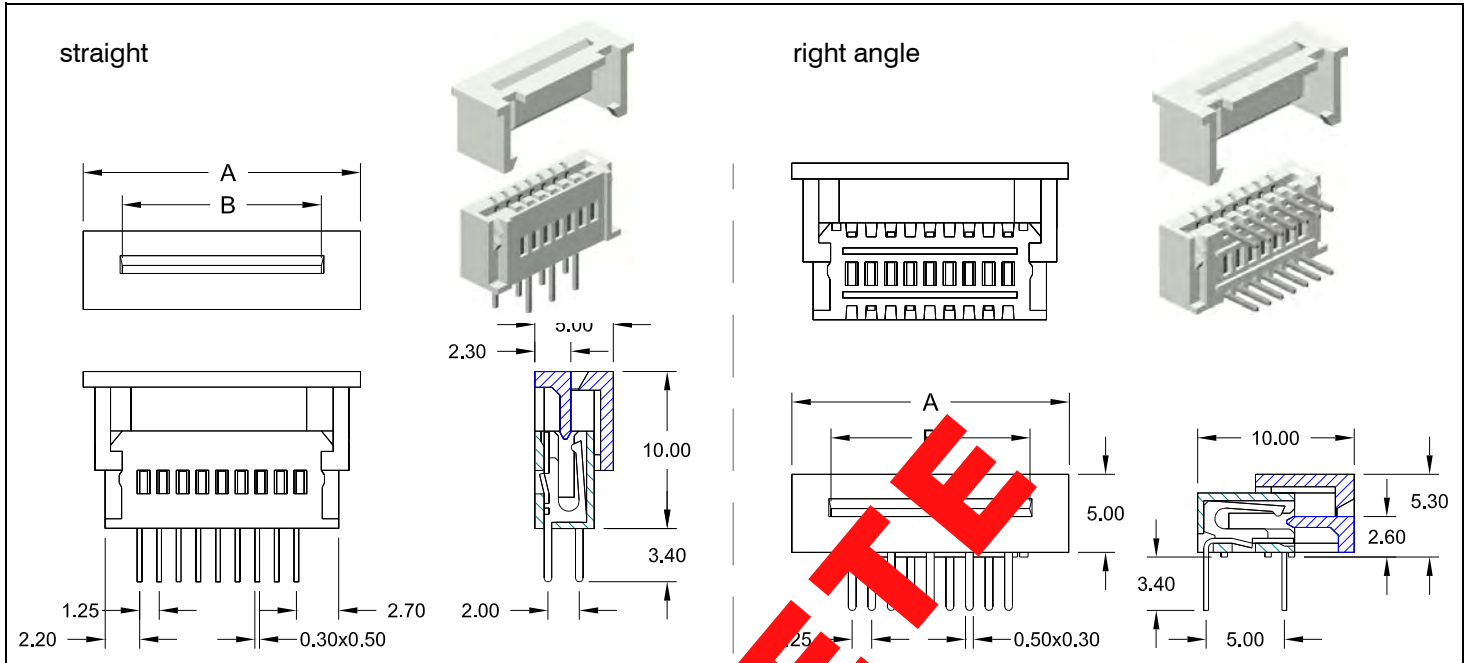

PCB Hole



Specifications

Current rating	1 A max.
Insulator resistance	100 MΩ min.
Contact resistance	20 mΩ max.
Withstanding voltage	100 V AC
Operating temperature	-20°C to +85°C
Contact material	Phosphor Bronze (RoHS compliant)
Contact plating	Tin (leadfree)
Insulator material	PBT (RoHS compliant) UL 94 V-0

Recommended FPC/FFC dimensions

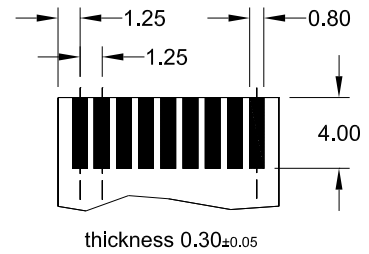

Dimensions (mm)

Contacts	DIM "A"	DIM "B"	Contacts	DIM "A"	DIM "B"	Contacts	DIM "A"	DIM "B"	Contacts	DIM "A"	DIM "B"
003	9.55	5.20	011	19.55	15.20	019	29.55	25.20	027	39.55	35.20
004	10.80	6.45	012	20.80	16.45	020	30.80	26.45	028	40.80	36.45
005	12.05	7.70	013	22.05	17.70	021	32.05	27.70	029	42.05	37.70
006	13.30	8.95	014	23.30	18.95	022	33.30	28.95	030	43.30	38.95
007	14.55	10.20	015	24.55	20.20	023	34.55	30.20	031	44.55	40.20
008	15.80	11.45	016	25.80	21.45	024	35.80	31.45	032	45.80	41.45
009	17.05	12.70	017	27.05	22.70	025	37.05	32.70			
010	18.30	13.95	018	28.30	23.95	026	38.30	33.95			

How to order

FCZ - xxx - X 125 - 99

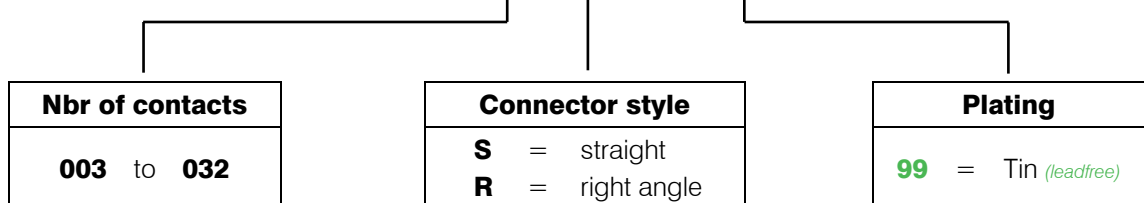

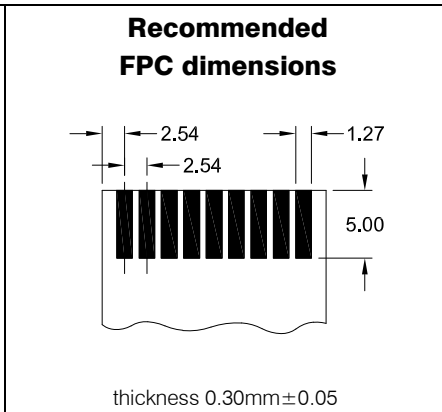
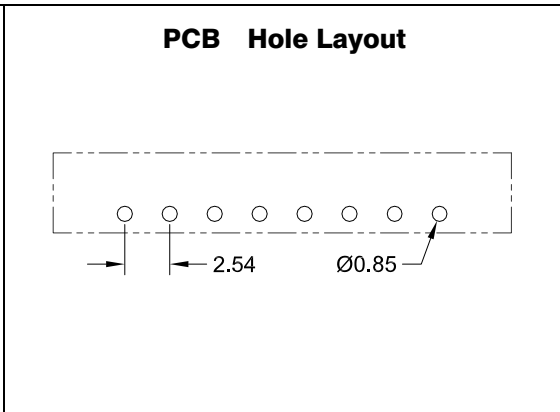
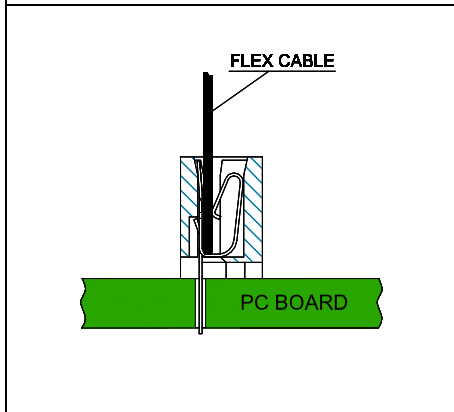
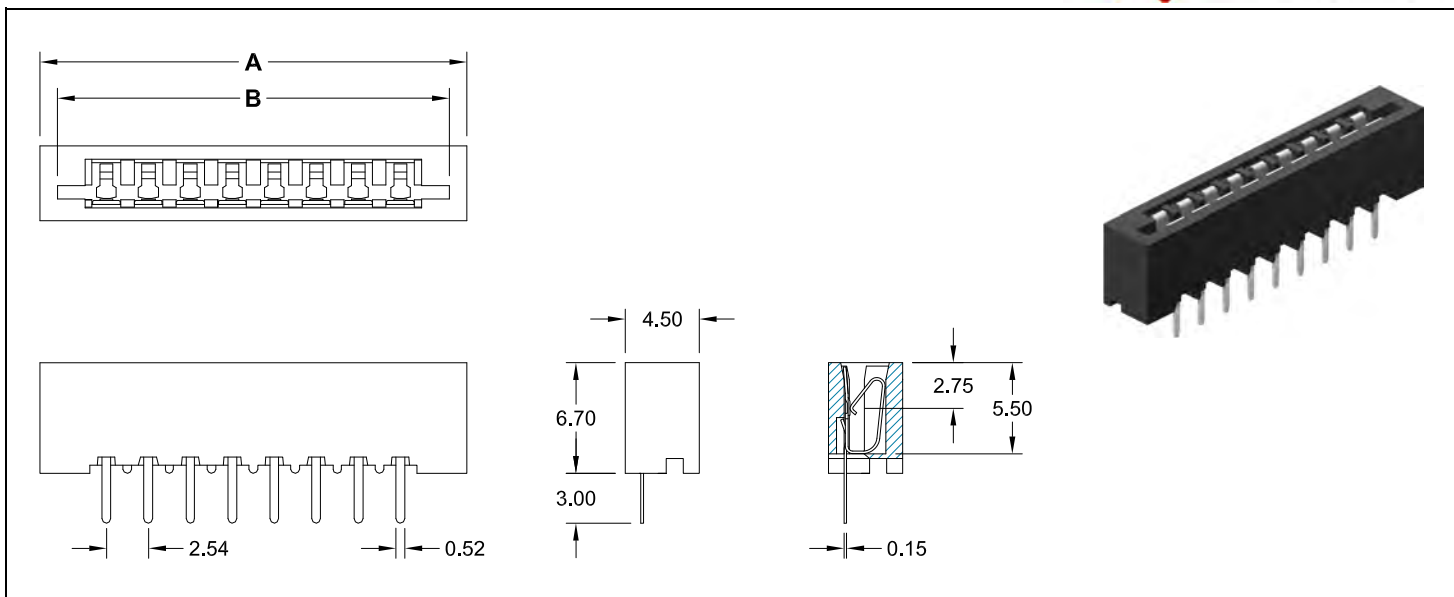

Specifications

Current rating	1.0 A max.	Operating temperature	- 20°C to +85°C
Insulation resistance	1000 MΩ min.	Contact material	Phosphor Bronze (RoHS compliant)
Contact resistance	30 mΩ max.	Contact plating	Tin (leadfree)
Withstanding voltage	500 V AC	Insulator material	PA9T (black) UL 94 V-0 (RoHS compliant)

Dimensions (mm)

Contacts	DIM "A"	DIM "B"	Contacts	DIM "A"	DIM "B"	Contacts	DIM "A"	DIM "B"	Contacts	DIM "A"	DIM "B"
002	10.54	8.43	009	28.32	26.21	016	46.10	43.99	023	63.88	61.77
003	13.08	10.97	010	30.86	28.75	017	48.64	46.53	024	66.42	64.31
004	15.62	13.51	011	33.40	31.29	018	51.18	49.07	025	68.96	66.85
005	18.16	16.05	012	35.94	33.83	019	53.72	51.60	026	71.50	69.39
006	20.70	18.59	013	38.48	36.37	020	56.26	54.15			
007	23.24	21.13	014	41.02	38.91	021	58.80	56.69			
008	25.78	23.67	015	43.56	41.45	022	61.34	59.23			

How to order

FPC - xxx - S254 - 99

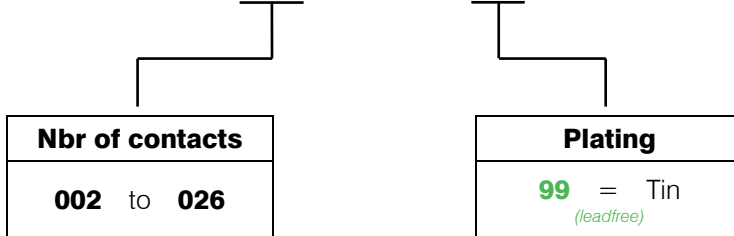

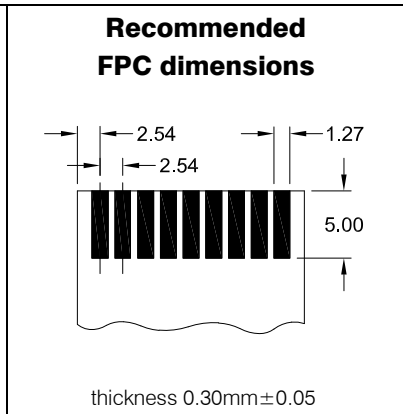
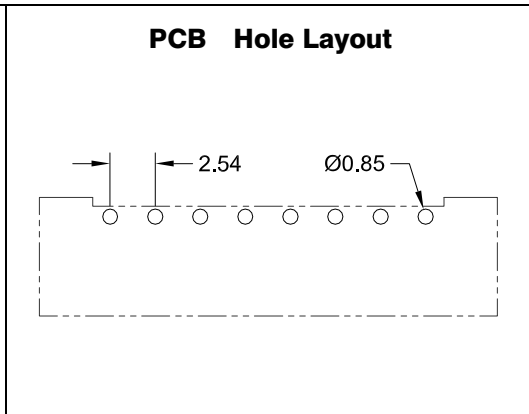
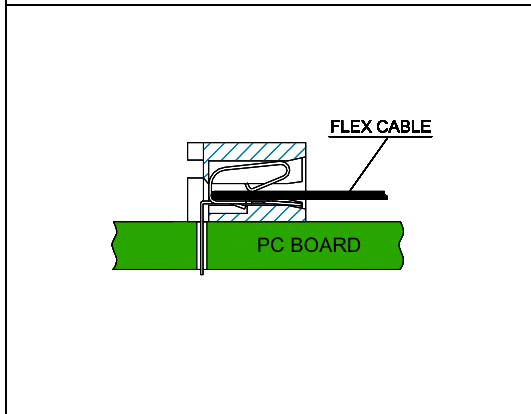
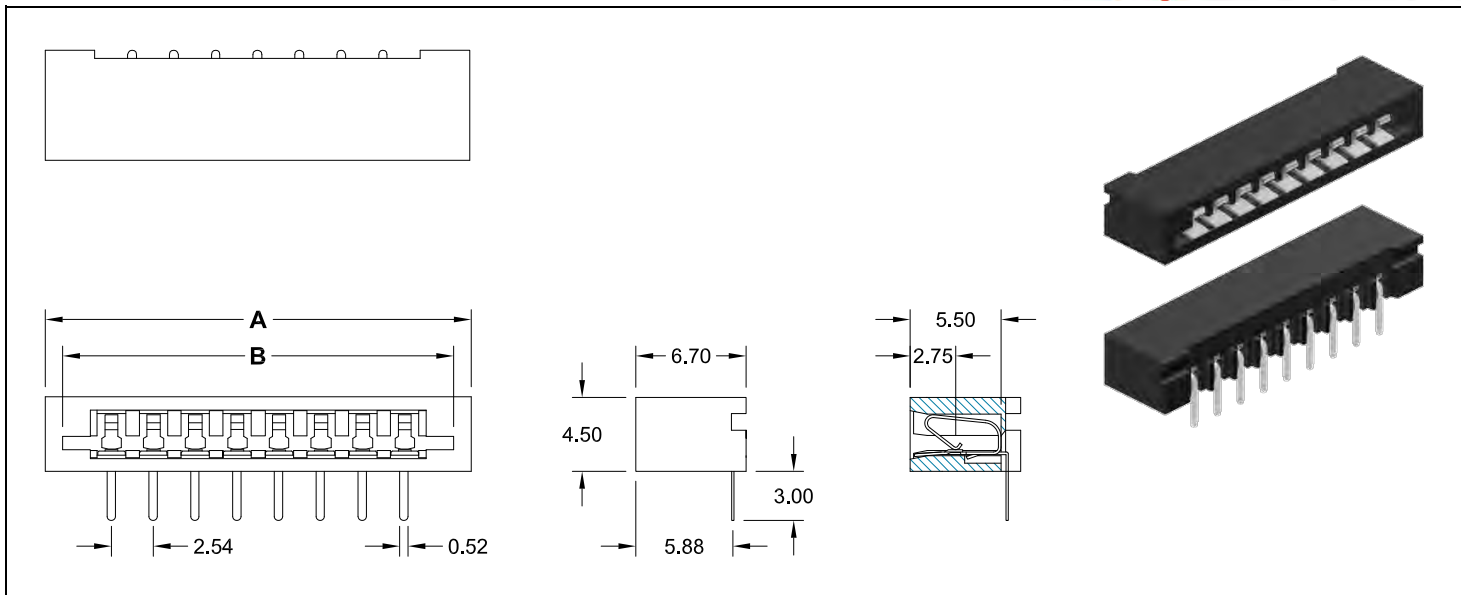

Specifications

Current rating	1.0 A max.	Operating temperature	- 20°C to +85°C
Insulation resistance	1000 MΩ min.	Contact material	Phosphor Bronze (RoHS compliant)
Contact resistance	30 mΩ max.	Contact plating	Tin (leadfree)
Withstanding voltage	500 V AC	Insulator material	PA9T (black) UL 94 V-0 (RoHS compliant)

Dimensions (mm)

Contacts	DIM "A"	DIM "B"	Contacts	DIM "A"	DIM "B"	Contacts	DIM "A"	DIM "B"	Contacts	DIM "A"	DIM "B"
002	10.54	8.43	009	28.32	26.21	016	46.10	43.99	023	63.88	61.77
003	13.08	10.97	010	30.86	28.75	017	48.64	46.53	024	66.42	64.31
004	15.62	13.51	011	33.40	31.29	018	51.18	49.07	025	68.96	66.85
005	18.16	16.05	012	35.94	33.83	019	53.72	51.60	026	71.50	69.39
006	20.70	18.59	013	38.48	36.37	020	56.26	54.15			
007	23.24	21.13	014	41.02	38.91	021	58.80	56.69			
008	25.78	23.67	015	43.56	41.45	022	61.34	59.23			

How to order

FPC - xxx - R254 - 99

Nbr of contacts
002 to 026

Plating
99 = Tin (leadfree)

Flex Cable

0.50mm to 2.54mm pitch

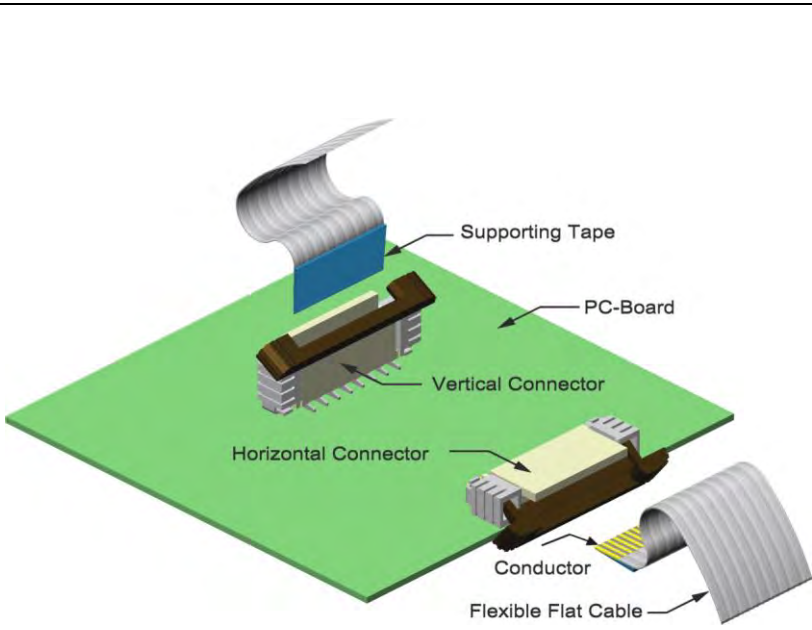

Specifications

Conductor resistance	according to JIS C-C3102 (@ 20°C)	
Insulation resistance (as per MIL-STD-202F Method 302 cond. B)	> 1000MΩ/Meter	
Dielectric strength (as per MIL-STD-202 Method 301)	500V AC / Minute	
Voltage rating	up to 2.54mm pitch:	60V AC
Current rating @20°C	0.50mm pitch:	0.4A
	0.80 & 1.00mm pitch:	1.0A
	1.25mm pitch:	1.5A
	2.54mm pitch:	2.0A
Temperature rating	-40°C to +85°C	
Flame Test	UL Sub, 758 VW-1	
Flexing Test		
A) Bending angle: 180°, R=Cable thickness	≥ 20 cycles	
B) R=10.00mm 70 cycle/Minute @23°C	≥ 100.000 cycles	
Abrasion Test following EN3475-503		
Tool: Ø0.50mm, Weight: 600g, Speed: 60 cycle/Min.	≥ 10.000 cycles	
Insulator	Polyester (white)	
Supporting Tape	Polyester (blue)	
Conductor	flat Copper Wire Tin or Gold plated	
Available UL Style:	20624/20798 (others on request)	

Dimensions

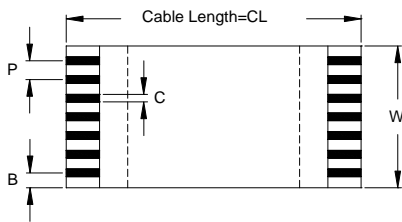

Cable Type

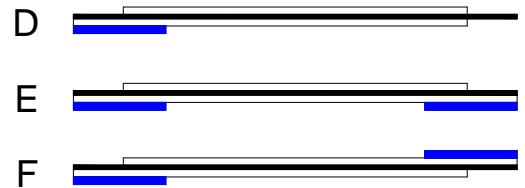

DIM (mm)	"P" (Pitch)	"C"	"B"	"W"	"CL"	"T"	"A1"	"A2"	"ST1" (Supporting Tape)	"ST2" (Supporting Tape)
Range	0.50 - 2.54	0.30 - 0.80	same as "P"	Px(n+1)	20.00 min.	0.30	3.00 - 6.00	3.00 - 6.00	6.00 - 15.00	6.00 - 15.00
Tolerance	±0.05	±0.05	±0.08	±0.10	see Note	±0.05	±1.00	±1.00	±2.00	±2.00

Note: 20 - 100mm ±2.00mm 101 - 200mm ±3.00mm 201 - 300mm ±4.00mm >301mm ±5.00mm

How to order

FCA - x xx - X xxx - 4 4 06 10 - x

Pitch	Nbr of Conductors	Cable Type	Cable length "CL"	Cable End	Conductor plating
1 = 0.50 mm	04 - 200	D E F	Example: 050 = 50.00mm 100 = 100.00mm	Example: 4 4 06 10 A1 A2 ST1 ST2 4.0 mm 4.0 mm 6.0 mm 10.0 mm ST2 = 00 if Cable Type "D" blank if same as ST1, if different use code like ST1	9 = Tin (leadfree) 5 = Gold flash (on "A1" & "A2" area)
2 = 0.80 mm	06 - 100				
3 = 1.00 mm	02 - 100				
4 = 1.25 mm	02 - 84				
7 = 2.54 mm	03 - 38				

ZIF Test Sockets for Flex Cable

0.50mm to 2.54mm pitch

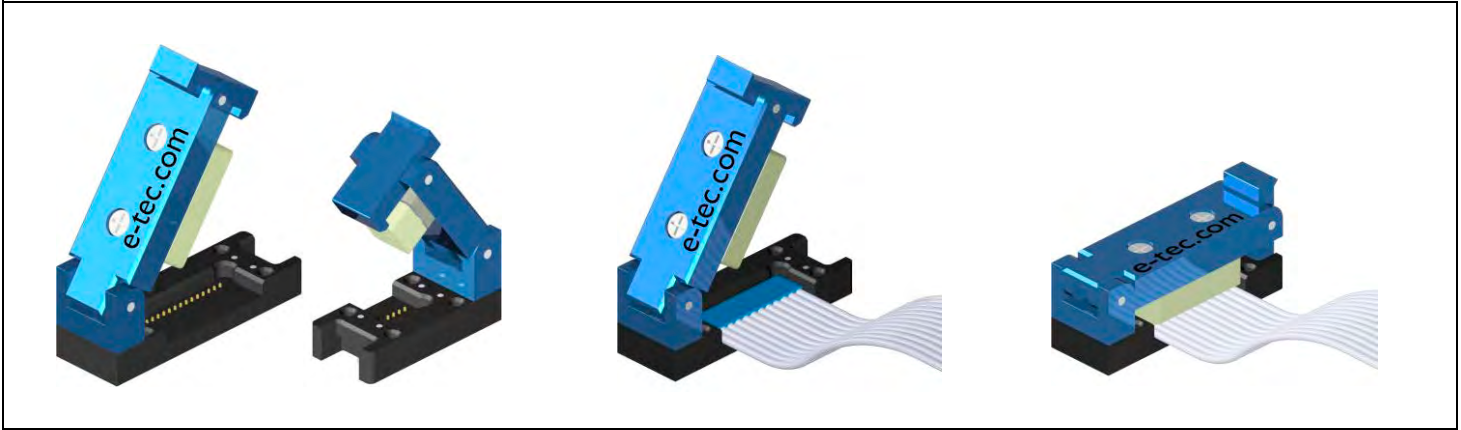

High cycle ZIF Test Sockets for any kind and pitch of Flex-Cable.

Handles up to 10K cycles with simple open/close ClamShell type retention frame.

Cable Dimensions

In order to be able to offer the correct socket for your cable, we need to know the type of cable you are using and the corresponding dimensions as shown below.

Please send the datasheet of your cable together with your socket request.

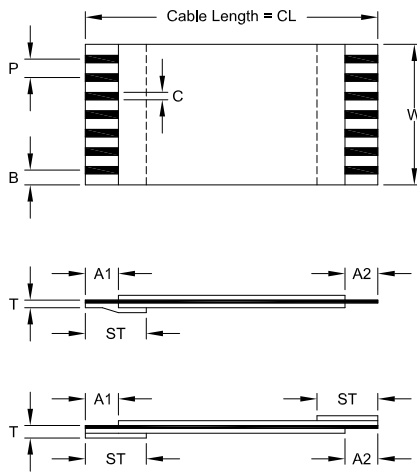

Specifications

Mechanical data

Contact life	10.000 cycles min.
Retention System life	10.000 cycles min.
Solderability	as per IEC 60068-2-58
Individual contact force	40 grams max.

Material

Insulator	(RoHS compliant)	High temp plastic or epoxy FR4
Terminal	(RoHS compliant)	Brass
Spring	(RoHS compliant)	BeCu

Electrical data

Contact resistance	< 100 mΩ
Current rating	500 mA max.
Insulation resistance at 500V DC	100 MΩ if 0.50 to 0.80mm pitch 500 MΩ 1.00mm pitch upwards
Breakdown voltage at 60 Hz	500V min.
Capacitance	< 1 pF
Inductance	< 2 nH

Operating temperature -55°C to +125°C

Processing temperature 260°C for 60sec.

A detailed socket drawing with the required PCB layout dimensions will be submitted by E-tec for each project.

How to order

FCT - X XX - X XXX - XX

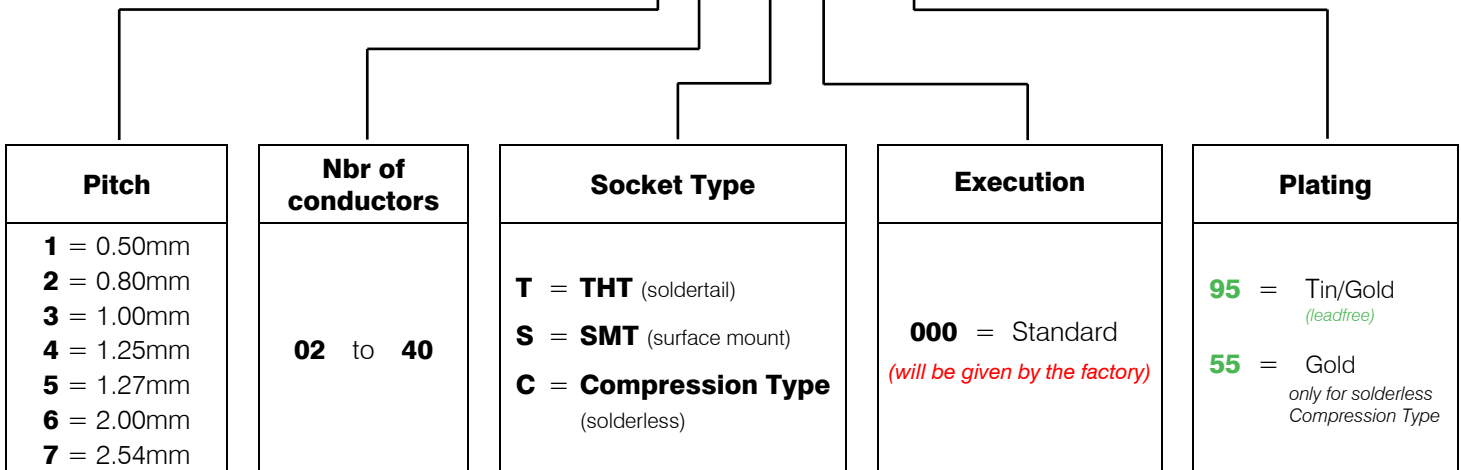

Mini – Flex Connector

IDC pitch 1.27mm shrouded male

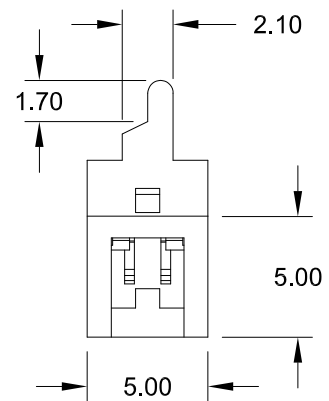
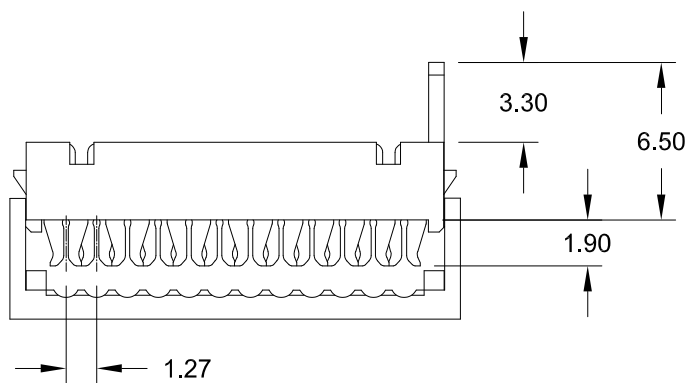
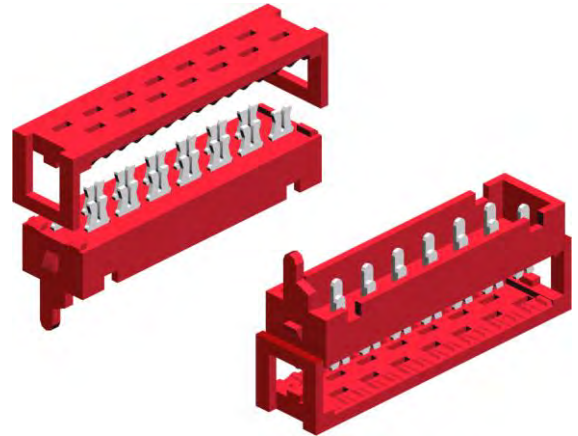
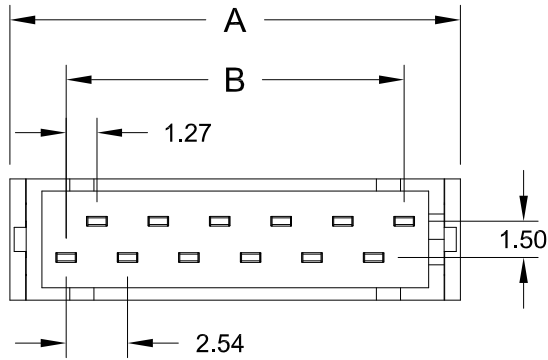

Specifications

Current rating	1.5 A max.
Voltage rating	230 V AC/DC
Withstanding voltage	500 V AC
Contact resistance	20 mΩ max.
Insulation resistance	1000 MΩ min.
Operating temperature	- 55°C to +105°C
Insulator material <i>(RoHS compliant)</i>	PBT (red) UL 94 V-0
Contact material <i>(RoHS compliant)</i>	Phosphor Bronze

Ribbon Cable Recommendation

Cable Type	Ribbon UL Style 2651
Spacing	1.27mm
Wire range	stranded 0.08 – 0.09 mm ² AWG 28 solid Ø 0.30 mm
Insulation Diameter	0.90 mm

Dimensions (mm)

Contacts	DIM "A"	DIM "B"	Contacts	DIM "A"	DIM "B"	Contacts	DIM "A"	DIM "B"
004	8.45	3.81	012	18.61	13.97	020	28.77	24.13
006	10.99	6.35	014	21.15	16.51			
008	13.53	8.89	016	23.69	19.05			
010	16.07	11.43	018	26.23	21.59			

How to order

MFM - xxx - DC50 - 99

Nbr of contacts

004; 006; 008; 010
012; 014; 016; 018
020

Plating

99 = Tin
(leadfree)
other platings
on request

Mini – Flex Connector

IDC pitch 1.27mm - THT - Plug

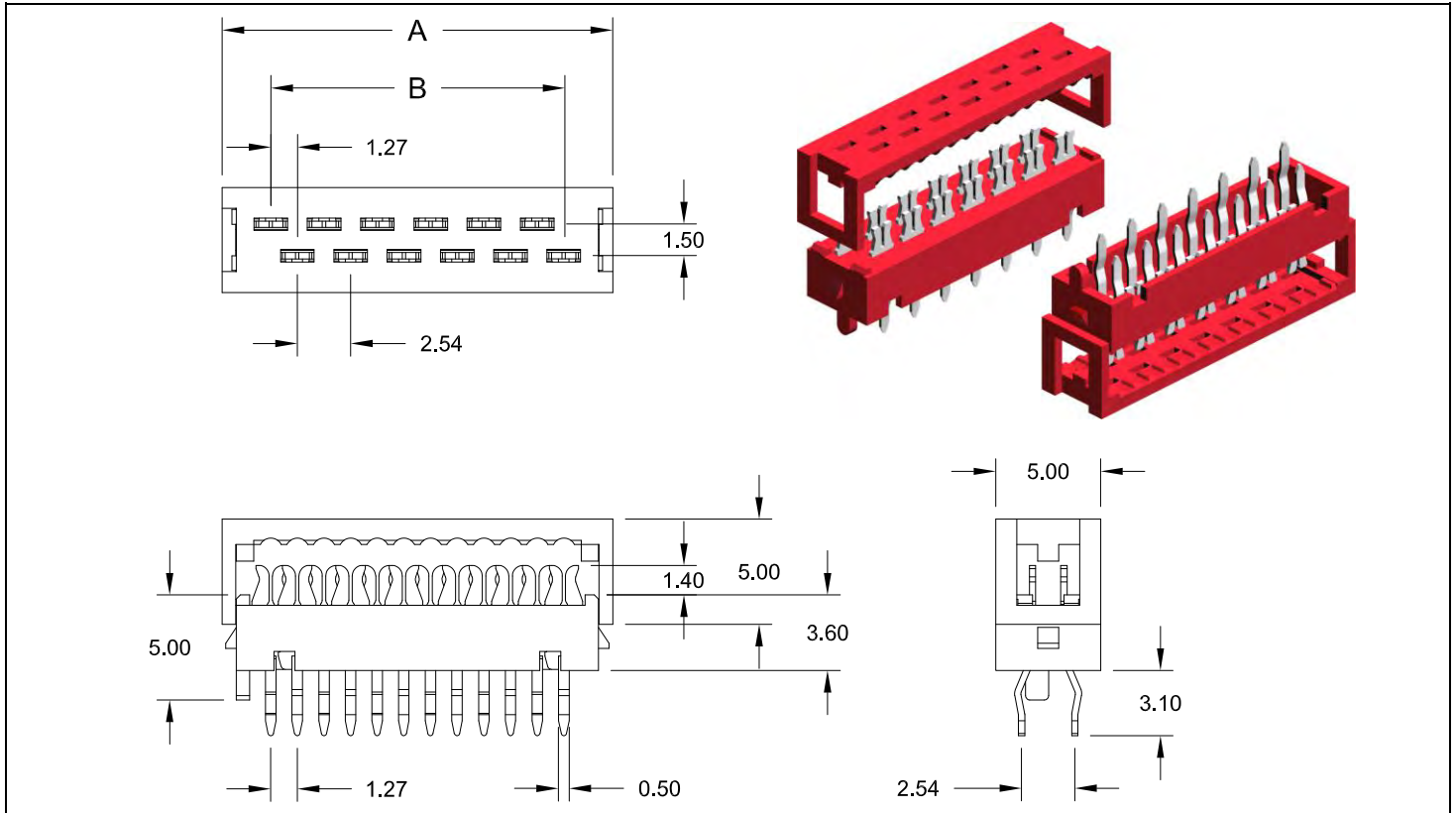

PCB Hole Layout

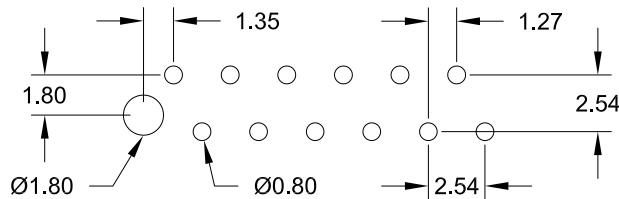

Specifications

Current rating	1.5 A max.
Voltage rating	230 V AC/DC
Withstanding voltage	500 V AC
Contact resistance	20 mΩ max.
Insulation resistance	1000 MΩ min.
Operating temperature	- 55°C to +105°C
Insulator material (RoHS compliant)	PBT (red) UL 94 V-0
Contact material (RoHS compliant)	Phosphor Bronze

Ribbon Cable Recommendation

Cable Type	Ribbon UL Style 2651
Spacing	1.27mm
Wire range	stranded 0.08 – 0.09 mm ² AWG 28 solid Ø 0.30 mm
Insulation Diameter	0.90 mm

Dimensions (mm)

Contacts	DIM "A"	DIM "B"	Contacts	DIM "A"	DIM "B"	Contacts	DIM "A"	DIM "B"
004	8.45	3.81	012	18.61	13.97	020	28.77	24.13
006	10.99	6.35	014	21.15	16.51			
008	13.53	8.89	016	23.69	19.05			
010	16.07	11.43	018	26.23	21.59			

How to order

MFP - xxx - DC50 - 99

Nbr of contacts

004; 006; 008; 010
012; 014; 016; 018
020

Plating

99 = Tin
(leadfree)
other platings
on request

Mini - Mate Connector

- SMT - female Block Shape

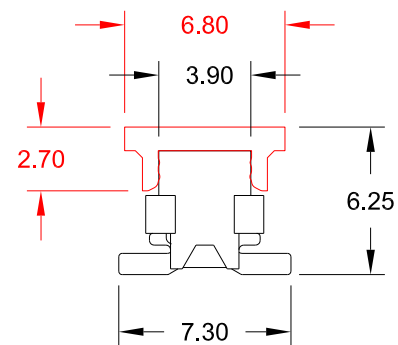
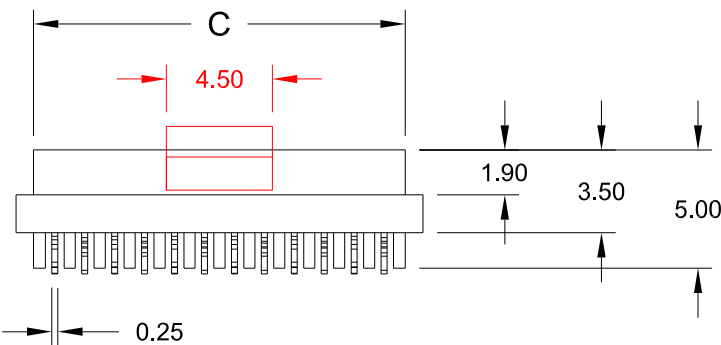
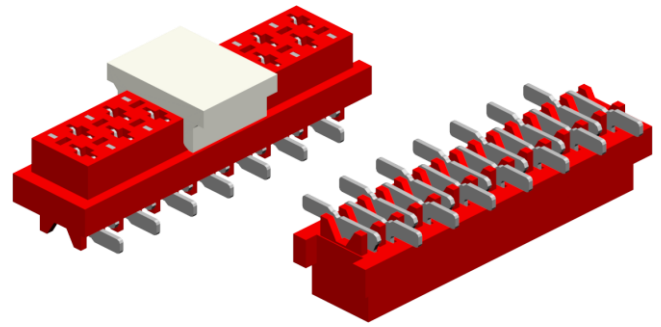
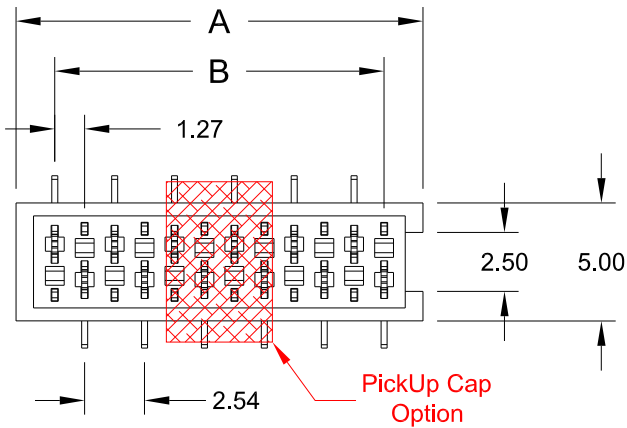

Specifications

Current rating	1.5 A max.
Voltage rating	230 V AC/DC
Withstanding voltage	500 V AC
Contact resistance	20 mΩ max.
Insulation resistance	1000 MΩ min.
Operating temperature	-55°C to +105°C
Processing temperature	+260°C +0/-5°C for 5 Sec.
Insulator material	(RoHS compliant) PA46 (red) UL 94 V-0
Contact material	(RoHS compliant) Phosphor Bronze

PCB Surface Mount Layout

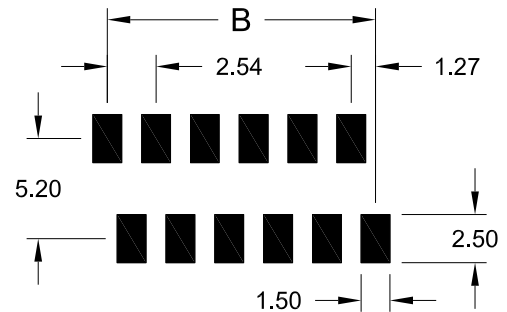

Dimensions (mm)

Contacts	DIM "A"	DIM "B"	DIM "C"	Contacts	DIM "A"	DIM "B"	DIM "C"	Contacts	DIM "A"	DIM "B"	DIM "C"
004	7.00	3.81	5.60	012	17.16	13.97	15.76	020	27.32	24.13	25.92
006	9.54	6.35	8.14	014	19.70	16.51	18.30				
008	12.08	8.89	10.68	016	22.24	19.05	20.84				
010	14.62	11.43	13.22	018	24.78	21.59	23.38				

How to order

MMF - xxx - HB50 - 99/X

Nbr of contacts
004; 006; 008; 010 012; 014; 016; 018 020

Plating
99 = Tin (leadfree) other platings on request

Option
A = Tube packing; with "PickUp Cap" B = Reel packing; with "PickUp Cap" T = Tube packing; without "PickUp Cap"

Mini - Mate Connector

- THT - straight female Block Shape

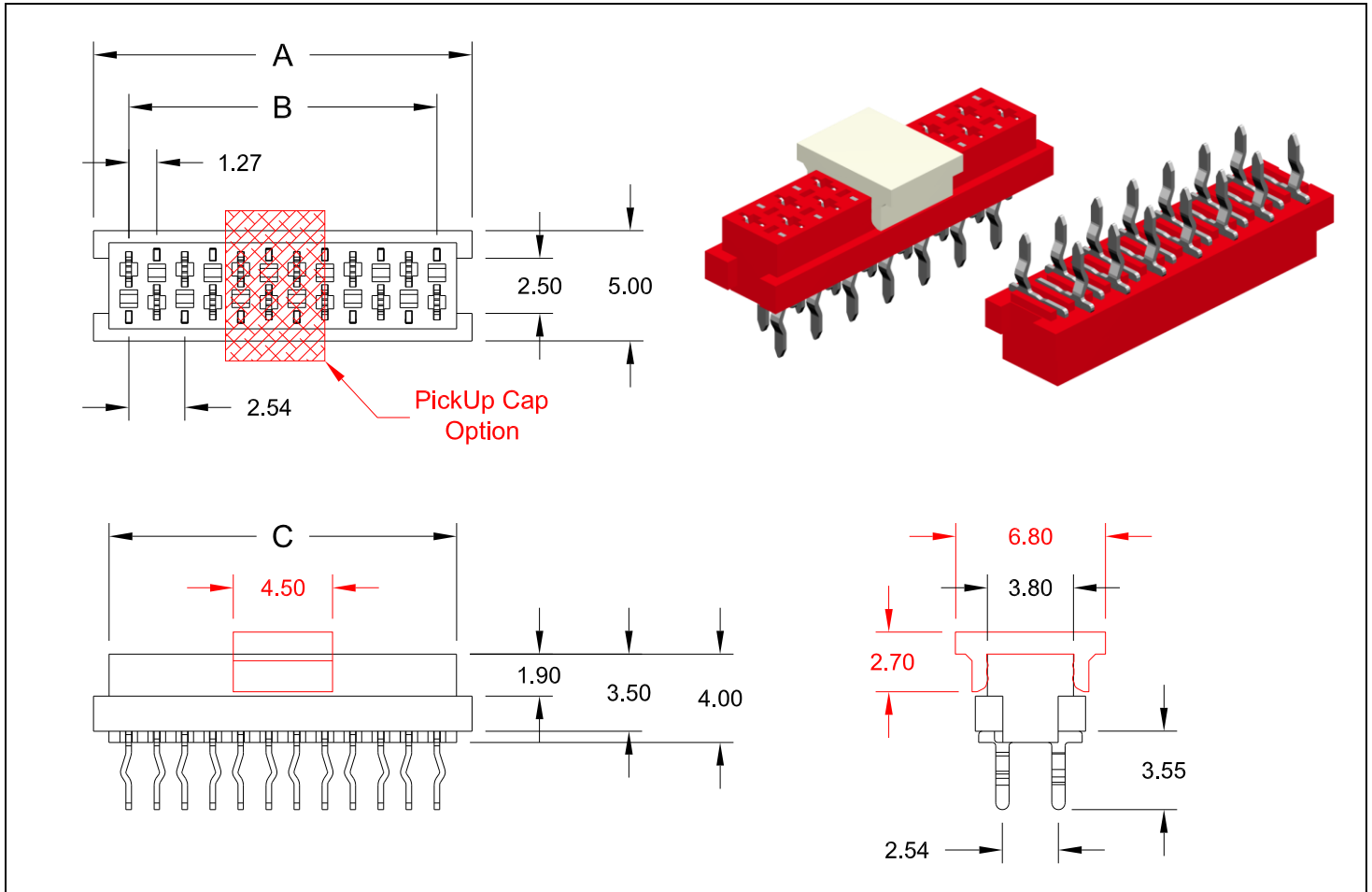

Specifications

Current rating	1.5 A max.
Voltage rating	230 V AC/DC
Withstanding voltage	500 V AC
Contact resistance	20 mΩ max.
Insulation resistance	1000 MΩ min.
Operating temperature	- 55°C to +105°C
Processing temperature	+260°C +0/-5°C for 5 Sec.
Insulator material	(RoHS compliant) PA46 (red) UL 94 V-0
Contact material	(RoHS compliant) Phosphor Bronze

PCB Hole Layout

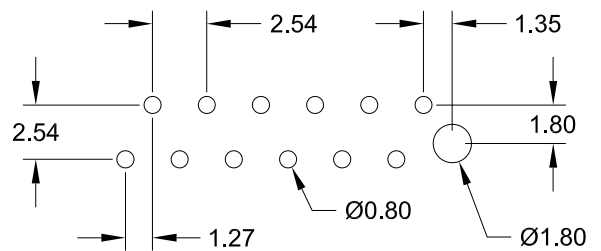

Dimensions (mm)

Contacts	DIM "A"	DIM "B"	DIM "C"	Contacts	DIM "A"	DIM "B"	DIM "C"	Contacts	DIM "A"	DIM "B"	DIM "C"
004	7.00	3.81	5.60	012	17.16	13.97	15.76	020	27.32	24.13	25.92
006	9.54	6.35	8.14	014	19.70	16.51	18.30				
008	12.08	8.89	10.68	016	22.24	19.05	20.84				
010	14.62	11.43	13.22	018	24.78	21.59	23.38				

How to order

MMF - xxx - SB50 - 99 /X

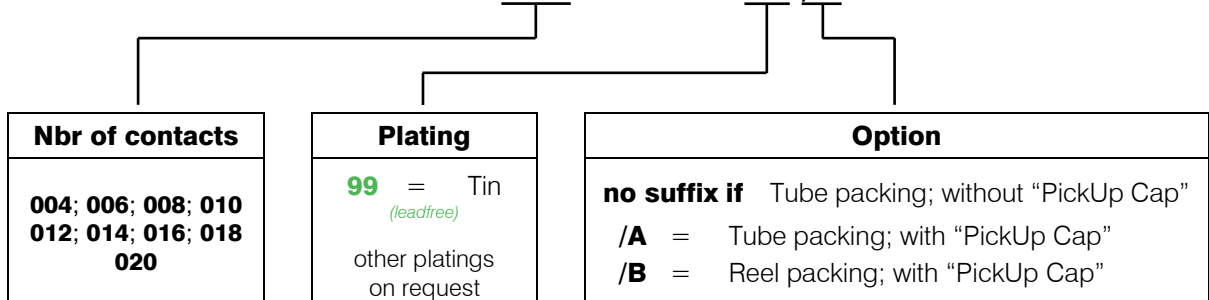

Mini - Mate Connector

- SMT - female Latch Shape

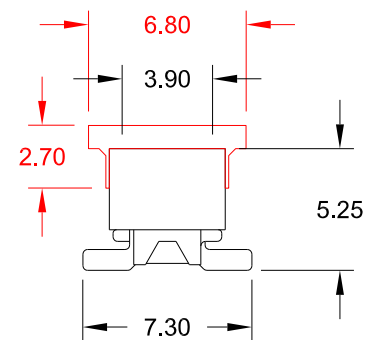
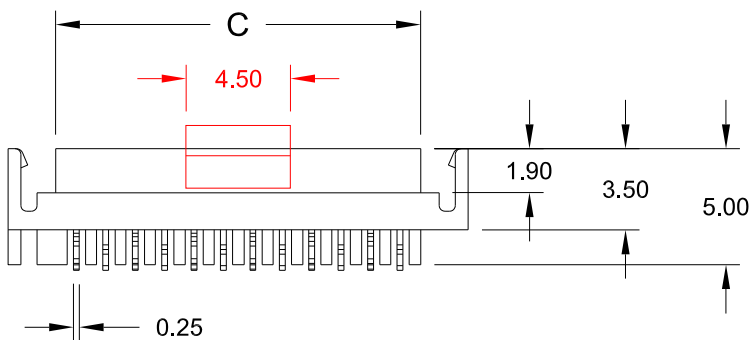
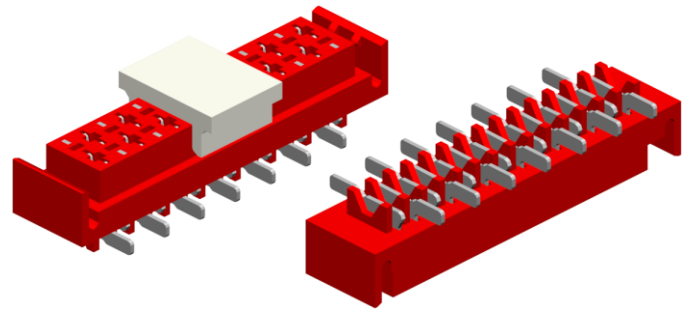
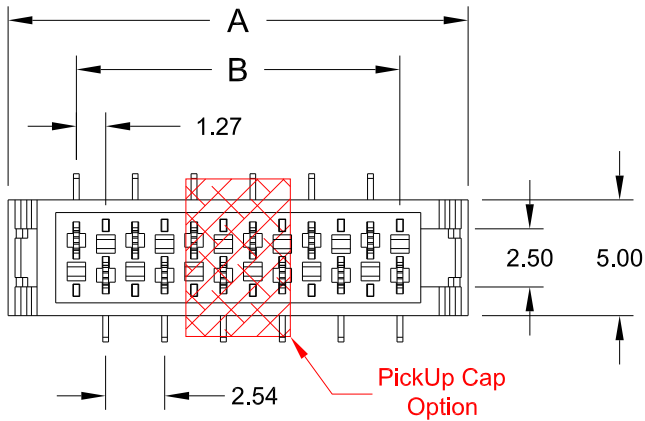

Specifications

Current rating	1.5 A max.
Voltage rating	230 V AC/DC
Withstanding voltage	500 V AC
Contact resistance	20 mΩ max.
Insulation resistance	1000 MΩ min.
Operating temperature	-55°C to +105°C
Processing temperature	+260°C +0/-5°C for 5 Sec.
Insulator material (RoHS compliant)	PA46 (red) UL 94 V-0
Contact material (RoHS compliant)	Phosphor Bronze

PCB Surface Mount Layout

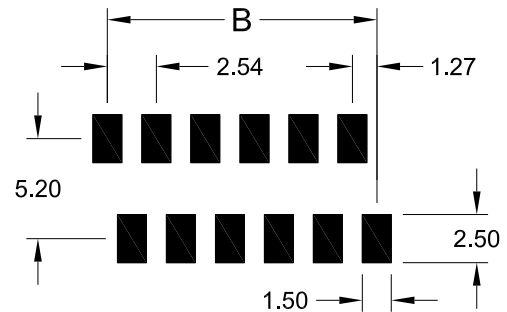

Dimensions (mm)

Contacts	DIM "A"	DIM "B"	DIM "C"	Contacts	DIM "A"	DIM "B"	DIM "C"	Contacts	DIM "A"	DIM "B"	DIM "C"
004	9.70	3.81	5.60	012	19.86	13.97	15.76	020	30.02	24.13	25.92
006	12.24	6.35	8.14	014	22.40	16.51	18.30				
008	14.78	8.89	10.68	016	24.94	19.05	20.84				
010	17.32	11.43	13.22	018	27.48	21.59	23.38				

How to order

MMF - xxx - HL50 - 99/X

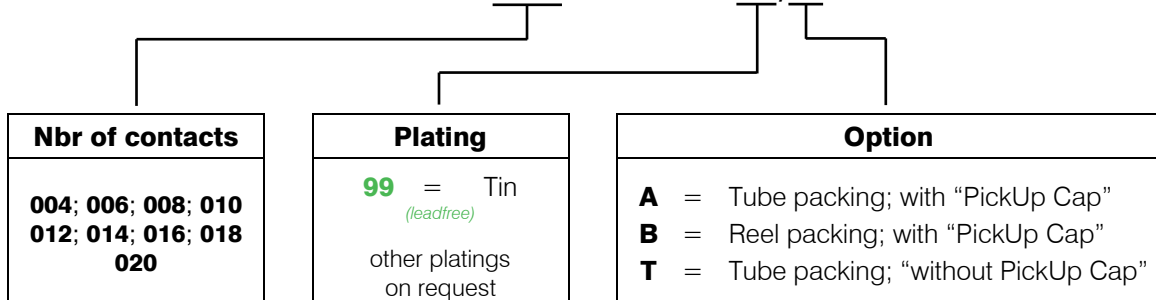

Mini - Mate Connector

- THT - straight female Latch Shape

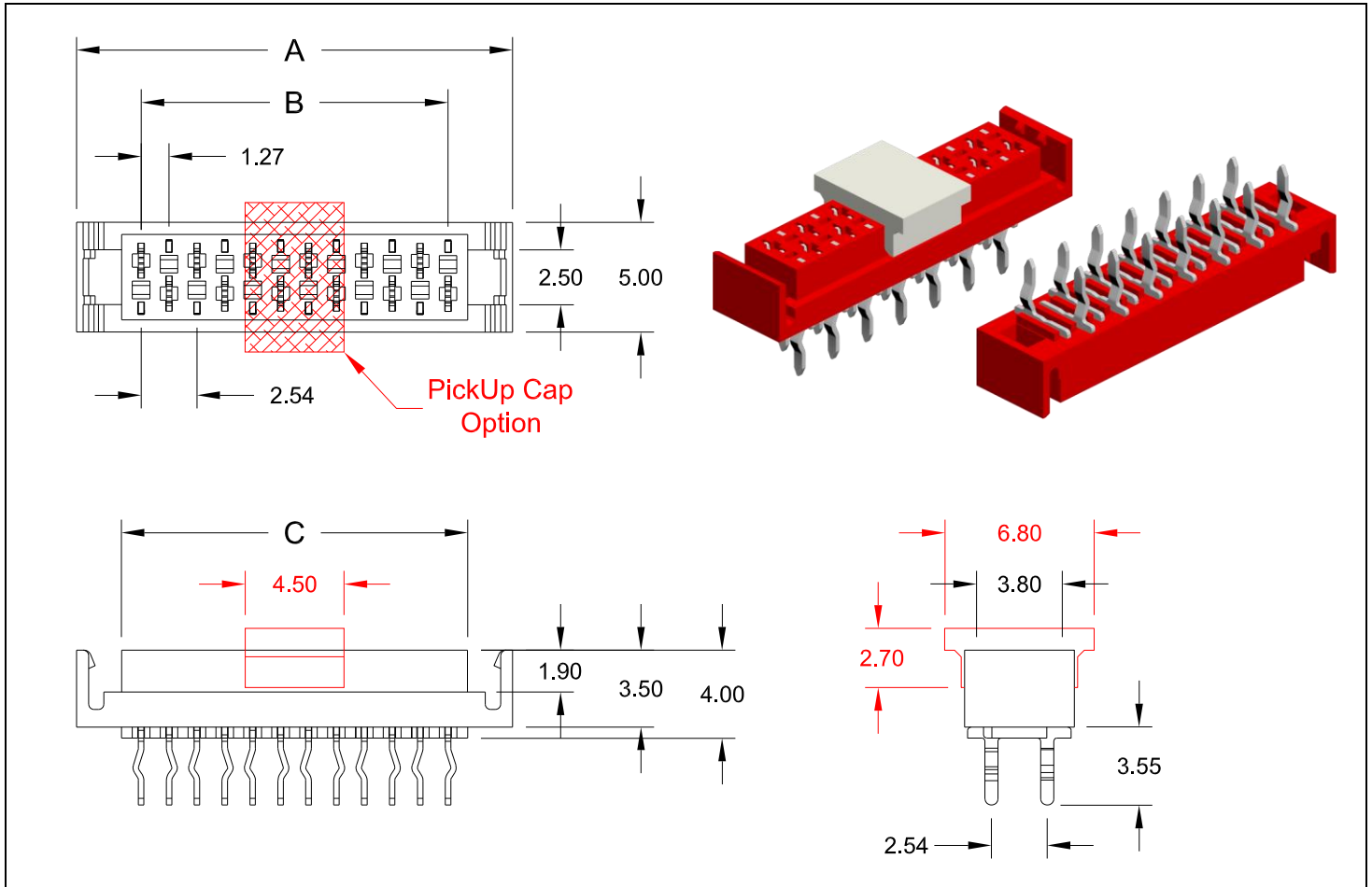

Specifications

Current rating	1.5 A max.
Voltage rating	230 V AC/DC
Withstanding voltage	500 V AC
Contact resistance	20 mΩ max.
Insulation resistance	1000 MΩ min.
Operating temperature	- 55°C to +105°C
Processing temperature	+260°C +0/-5°C for 5 Sec.
Insulator material	(RoHS compliant) PA46 (red) UL 94 V-0
Contact material	(RoHS compliant) Phosphor Bronze

PCB Hole Layout

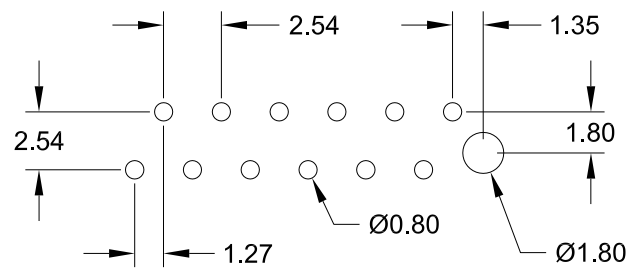

Dimensions (mm)

Contacts	DIM "A"	DIM "B"	DIM "C"	Contacts	DIM "A"	DIM "B"	DIM "C"	Contacts	DIM "A"	DIM "B"	DIM "C"
004	9.70	3.81	5.60	012	19.86	13.97	15.76	020	30.02	24.13	25.92
006	12.24	6.35	8.14	014	22.40	16.51	18.30				
008	14.78	8.89	10.68	016	24.94	19.05	20.84				
010	17.32	11.43	13.22	018	27.48	21.59	23.38				

How to order

MMF - xxx - SL50 - 99 /X

Nbr of contacts
004; 006; 008; 010 012; 014; 016; 018 020

Plating
99 = Tin (leadfree)
other platings on request

Option
no suffix if Tube packing; without "PickUp Cap"
/A = Tube packing; with "PickUp Cap"
/B = Reel packing; with "PickUp Cap"

Mini – Mate Connector

- THT - right angle female Block Shape

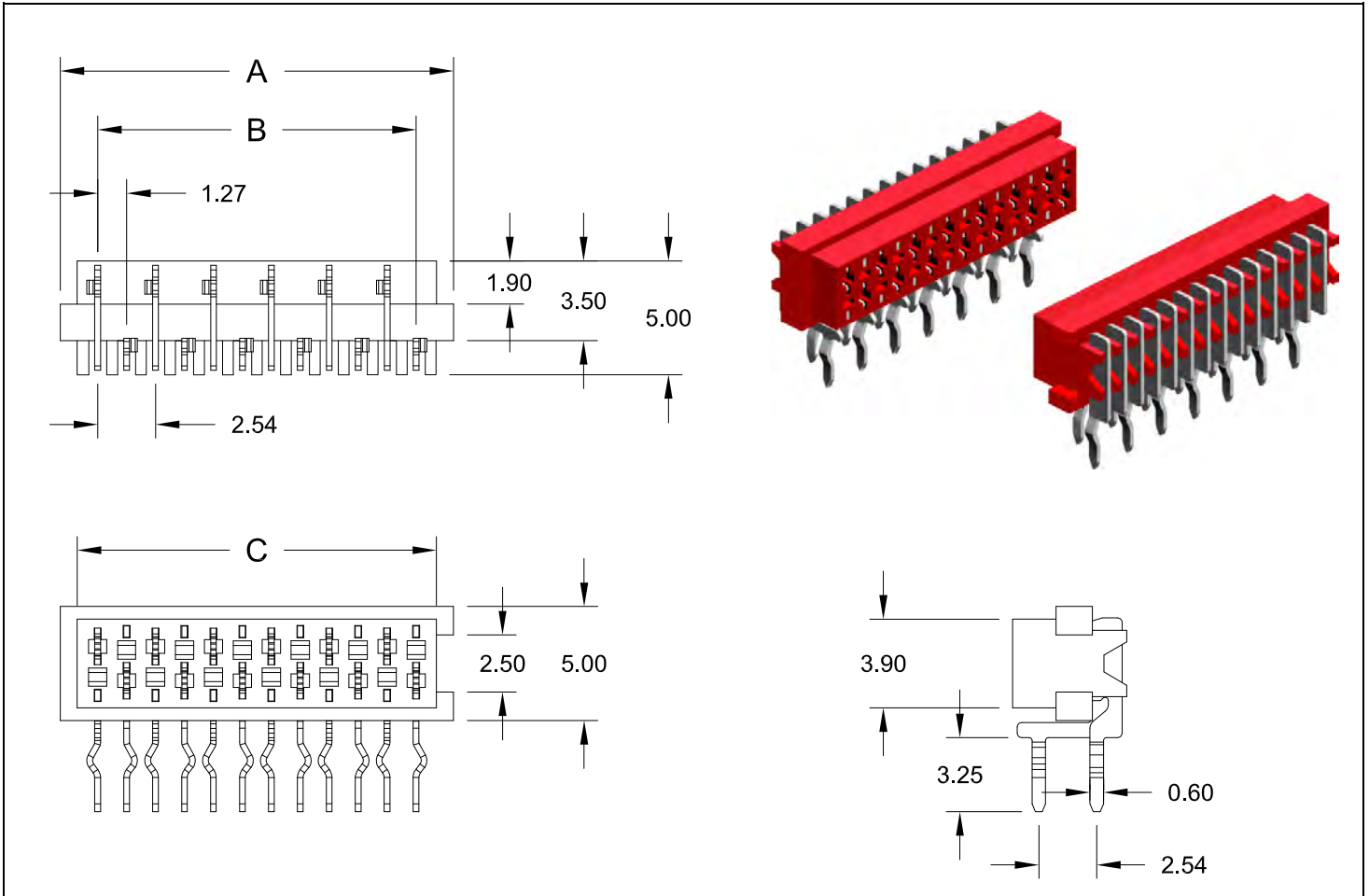

Specifications

Current rating	1.5 A max.
Voltage rating	230 V AC/DC
Withstanding voltage	500 V AC
Contact resistance	20 mΩ max.
Insulation resistance	1000 MΩ min.
Operating temperature	-55°C to +105°C
Processing temperature	+260°C +0/-5°C for 5 Sec.
Insulator material	(RoHS compliant) PA46 (red) UL 94 V-0
Contact material	(RoHS compliant) Phosphor Bronze

PCB Hole Layout

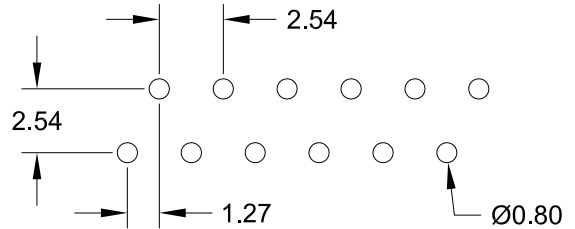

Dimensions (mm)

Contacts	DIM "A"	DIM "B"	DIM "C"	Contacts	DIM "A"	DIM "B"	DIM "C"	Contacts	DIM "A"	DIM "B"	DIM "C"
004	7.00	3.81	5.60	012	17.16	13.97	15.76	020	27.32	24.13	25.92
006	9.54	6.35	8.14	014	19.70	16.51	18.30				
008	12.08	8.89	10.68	016	22.24	19.05	20.84				
010	14.62	11.43	13.22	018	24.78	21.59	23.38				

How to order

MMF - xxx - RB50 - 99

Nbr of contacts

004; 006; 008; 010
012; 014; 016; 018
020

Plating

99 = Tin
(leadfree)
 other platings
 on request

Mini - Mate Connector

- THT - right angle female Latch Shape

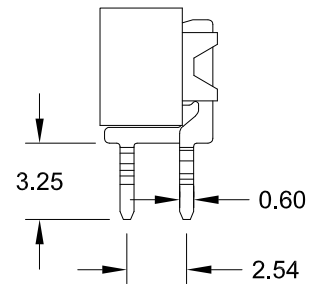
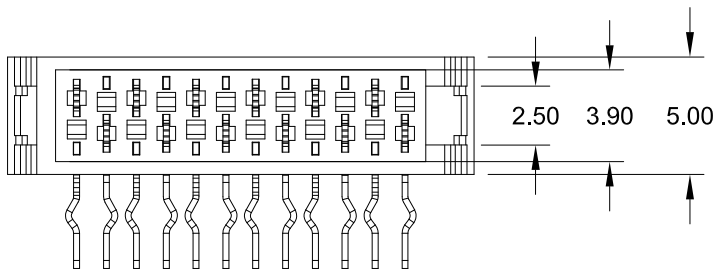
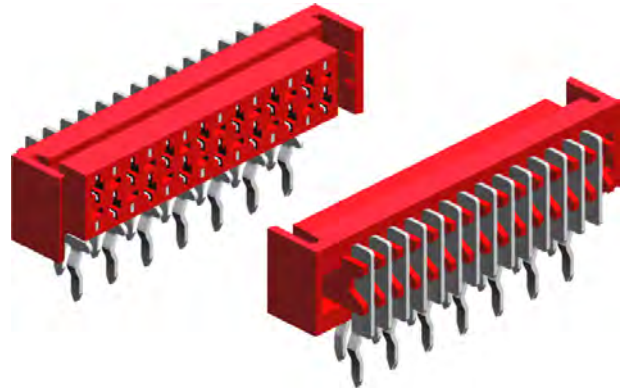
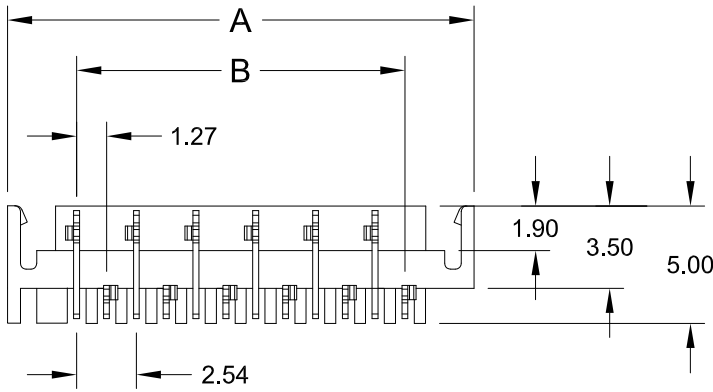

Specifications

Current rating	1.5 A max.
Voltage rating	230 V AC/DC
Withstanding voltage	500 V AC
Contact resistance	20 mΩ max.
Insulation resistance	1000 MΩ min.
Operating temperature	- 55°C to +105°C
Processing temperature	+260°C +0/-5°C for 5 Sec.
Insulator material	(RoHS compliant) PA46 (red) UL 94 V-0
Contact material	(RoHS compliant) Phosphor Bronze

PCB Hole Layout

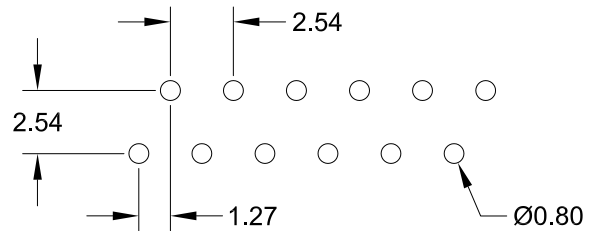

Dimensions (mm)

Contacts	DIM "A"	DIM "B"	DIM "C"	Contacts	DIM "A"	DIM "B"	DIM "C"	Contacts	DIM "A"	DIM "B"	DIM "C"
004	9.70	3.81	5.60	012	19.86	13.97	15.76	020	30.02	24.13	25.92
006	12.24	6.35	8.14	014	22.40	16.51	18.30				
008	14.78	8.89	10.68	016	24.94	19.05	20.84				
010	17.32	11.43	13.22	018	27.48	21.59	23.38				

How to order

MMF - xxx - RL50 - 99

Nbr of contacts

004; 006; 008; 010
012; 014; 016; 018
020

Plating

99 = Tin
(leadfree)
 other platings
 on request

Mini - Mate Connector

- THT - straight male Shrouded

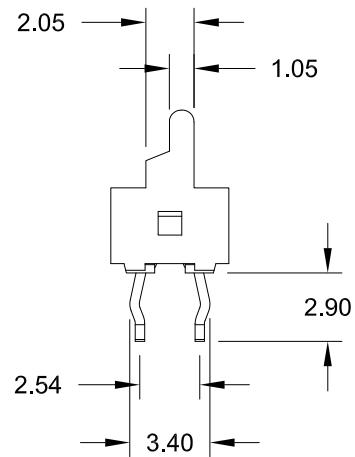
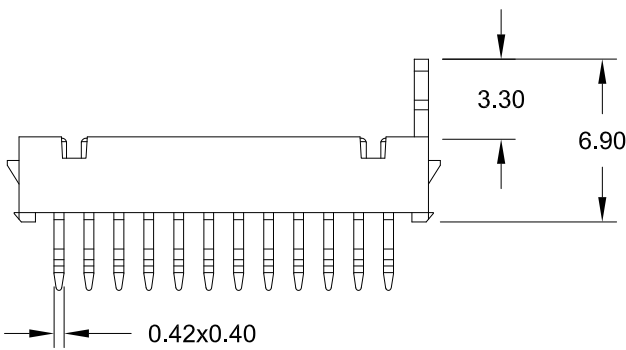
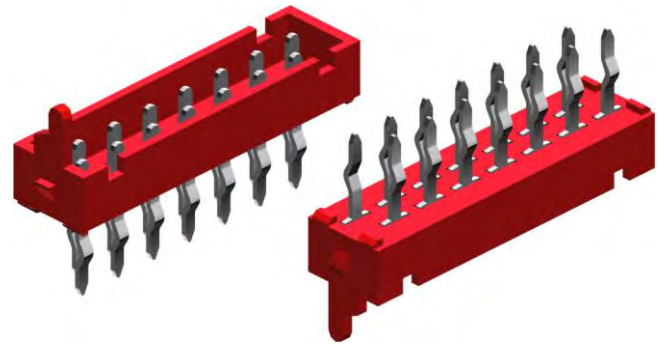
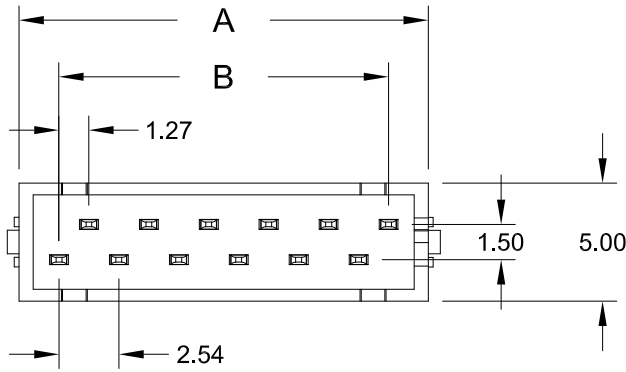

Specifications

Current rating	1.5 A max.
Voltage rating	230 V AC/DC
Withstanding voltage	500 V AC
Contact resistance	20 mΩ max.
Insulation resistance	1000 MΩ min.
Operating temperature	- 55°C to +105°C
Insulator material	(RoHS compliant) PBT (red) UL 94 V-0
Contact material	(RoHS compliant) Phosphor Bronze

PCB Hole Layout

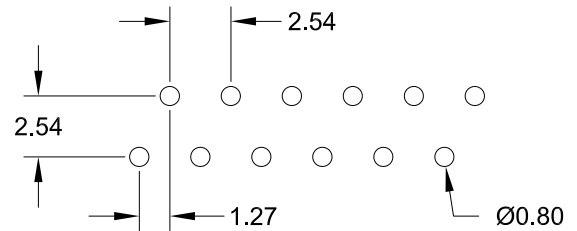

Dimensions (mm)

Contacts	DIM "A"	DIM "B"	Contacts	DIM "A"	DIM "B"	Contacts	DIM "A"	DIM "B"
004	7.20	3.81	012	17.36	13.97	020	27.52	24.13
006	9.74	6.35	014	19.90	16.51			
008	12.28	8.89	016	22.44	19.05			
010	14.82	11.43	018	24.98	21.59			

How to order

MMM - xxx - SS50 - 99

Nbr of contacts

004; 006; 008; 010
012; 014; 016; 018
020

Plating

99 = Tin
(leadfree)
other platings
on request

Mini - Mate Connector

- SMT - shrouded male

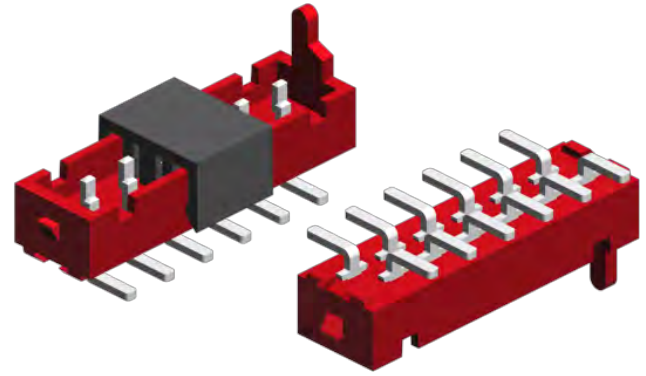
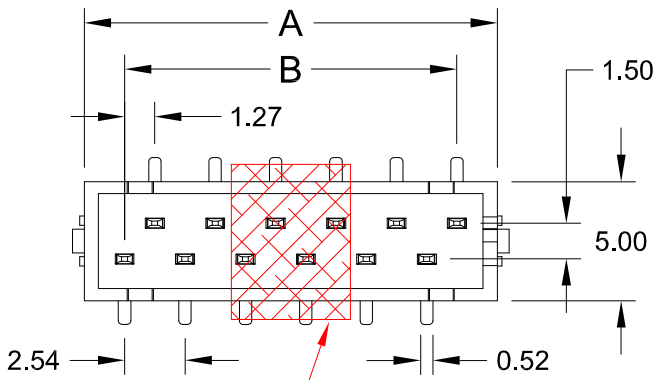

PickUp Cap Option

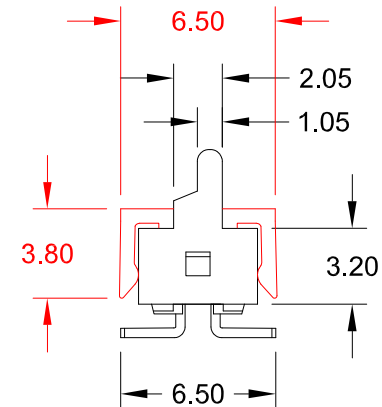
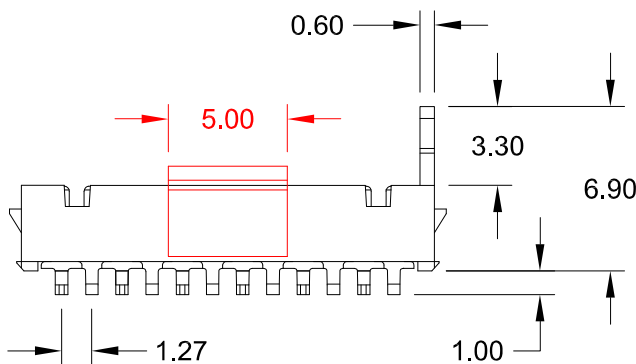

Specifications

Current rating	1.5 A max.
Voltage rating	230 V AC/DC
Withstanding voltage	500 V AC
Contact resistance	20 mΩ max.
Insulation resistance	1000 MΩ min.
Operating temperature	- 55°C to +105°C
Processing temperature	+260°C +0/-5°C for 5 Sec.
Insulator material	(RoHS compliant) PA46 (red) UL 94 V-0
Contact material	(RoHS compliant) Phosphor Bronze

PCB Surface Mount Layout

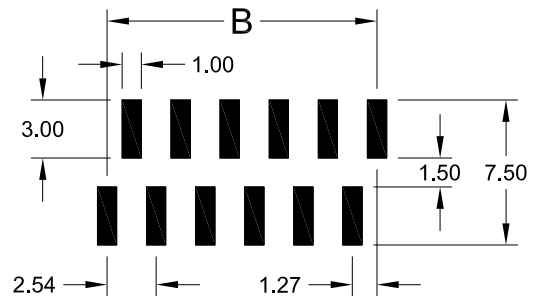

Dimensions (mm)

Contacts	DIM "A"	DIM "B"	Contacts	DIM "A"	DIM "B"	Contacts	DIM "A"	DIM "B"
004	7.20	3.81	012	17.36	13.97	020	27.52	24.13
006	9.74	6.35	014	19.90	16.51			
008	12.28	8.89	016	22.44	19.05			
010	14.82	11.43	018	24.98	21.59			

How to order

MMM - xxx - HS50 - 99/X

Nbr of contacts
004; 006; 008; 010 012; 014; 016; 018 020

Plating
99 = Tin (leadfree) other platings on request

Option
A = Tube packing; with "PickUp Cap"
T = Tube packing; without "PickUp Cap"
B = Reel packing; with "PickUp Cap"
R = Reel packing; without "PickUp Cap"

L - Type Female Plug

<p>single row</p> <p>Order Code Housing: CRF-1xx-L100 Contact: CRF-999/35-L100-99</p>	<p>dual row</p> <p>Order Code Housing: CRF-2xx-L100 Contact: CRF-999/35-L100-99</p>
---	---

L - Type Male Header

<p>single row -SMT- straight (top entry)</p> <p>Order Code: CRS-1xx-SL100-99/B</p>	<p>dual row -SMT- straight (top entry)</p> <p>Order Code: CRS-2xx-SL100-95/E</p>
<p>single row -SMT- right angle (side entry)</p> <p>Order Code: CRR-1xx-SL100-99/R</p>	<p>dual row -SMT- right angle (side entry)</p> <p>Order Code: CRR-2xx-SL100-99/R</p>

Specifications

Current rating	1 A	Voltage rating	50 V AC max.	Contact material	Phosphor Bronze
Insulation resistance	100 MΩ min.	Withstanding voltage	500 V AC	Insulator material	PA9T UL 94V-0
Contact resistance	20 mΩ max.	Operating temp.	-25°C to +85°C	CRR-2xx	PA6T UL 94-V0
		SMT Processing temp.	+250°C for 5 sec.	CRF Type	PA66 UL 94V-0

How to order

CR X - x xx - X 100 - 99 / X

Type	Rows	Nbr of Contacts	Execution	Plating	Packing
F = Female	1 = single row	02 to 20	L = Plug	99 = Tin <i>(leadfree)</i>	R = Reel
R = R/A Male	2 = dual row	20, 30, 40 & 50	SL = SMT	95 = Tin/Gold <i>(leadfree)</i>	B = Reel with PickUp Cap
S = Straight Male	<i>if Crimp Contact:</i>	<i>if Crimp Contact:</i> <small>(MOQ: 10K / reel)</small>	for details see above dwg's	other platings on request	E = Reel with PickUp Cap
	9	99/35 = AWG 28~32			

1.25mm Wire to Board Crimp Contact Connectors



S - Type Single Row

Female Plug

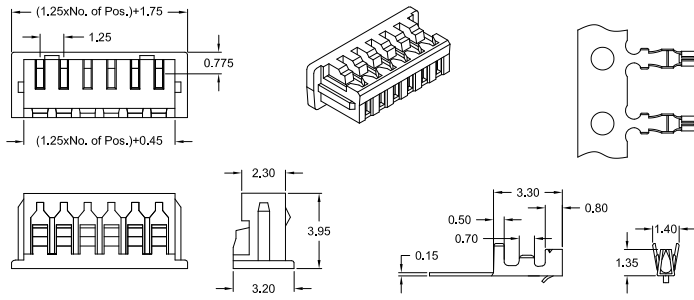

Order Code Housing: **CRF-1xx-S125**

Contact: **CRF-999/35-S125-99**

-THT- Male Header straight (top entry) & right angle (side entry)

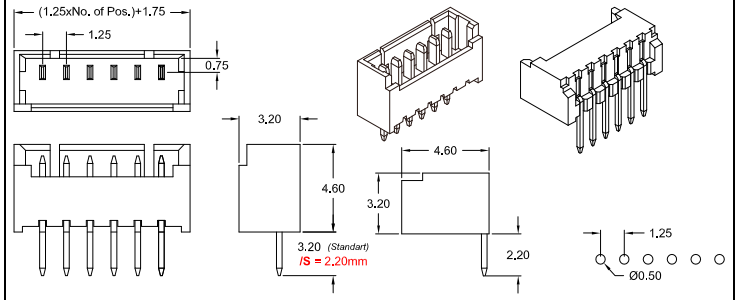

Order Code straight: **CRS-1xx-S125-99/S** right angle: **CRR-1xx-S125-99**

-SMT- Male Header right angle (side entry)

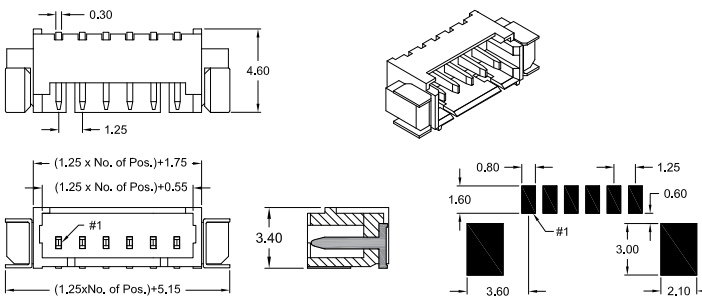

Order Code: **CRR-1xx-SS125-99/R**

-SMT- Male Header straight (top entry)

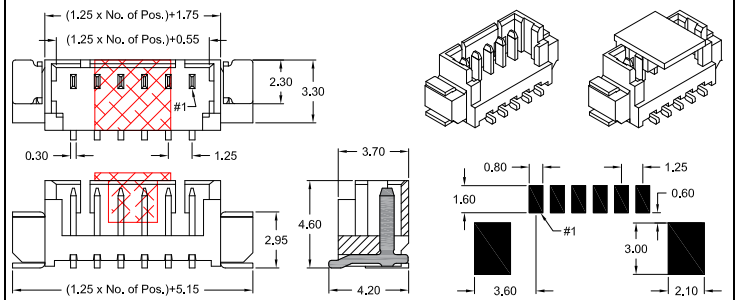

Order Code: **CRS-1xx-SS125-99/R**

CRS-1xx-SS125-99/B

D - Type Single Row

Female Plug

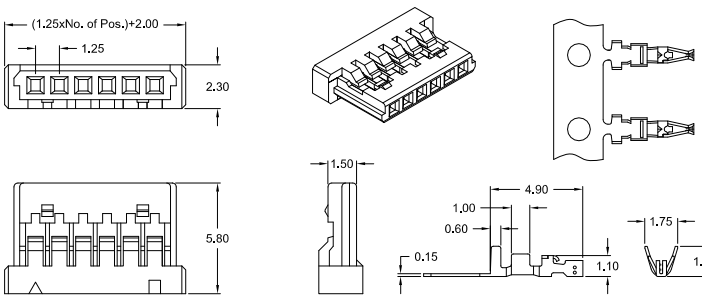

Order Code Housing: **CRF-1xx-D125**

Contact: **CRF-999/35-D125-95**

-SMT- Male Header right angle (side entry)

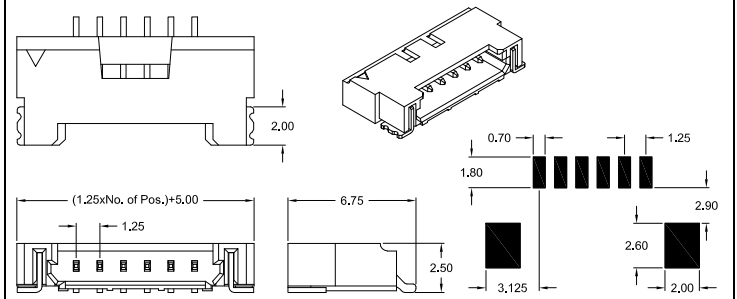

Order Code: **CRR-1xx-SD125-99/R**

Specifications

Current rating	1 A	Withstanding voltage	250 V AC	Contact material	Copper Alloy
Insulation resistance	100 MΩ min.	Operating temperature	-40°C to +85°C	Insulator material	PA6T UL 94V-0
Contact resistance	20 mΩ max.	D125 Type	-25°C to +85°C	CRF Type	PA66 UL 94V-0
Voltage rating	125 V AC	SMT Processing temp.	+250°C for 5 sec.	SD125 Type	PA9T UL 94V-0
				PCB thickness	1.60 mm

How to order

CR X - x xx - X 125 - 99 / X

Type	Rows	Nbr of Contacts	Execution	Plating	Packing
F = Female R = R/A Male S = Straight Male	1 = single row <i>if Crimp Contact:</i> 9	02 - 15 = S & SS - Type 02 - 30 = D & SD - Type <i>if Crimp Contact: (MOQ: 10K/reel)</i> 99/35 = AWG 28~32	S = Plug SS = SMT D = Plug SD = SMT for details see above dwg's	99 = Tin 95 = Tin/Gold <i>(tin leadfree)</i> other platings on request	R = Reel w/o PickUp Cap B = Reel with PickUp Cap

1.50mm Wire to Board Crimp Contact Connectors



K - Type Single Row

Female Plug

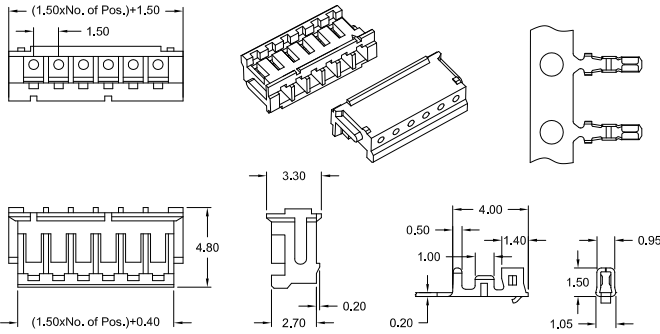

Order Code Housing: **CRF-1xx-K150** Contact: **CRF-999/35-K150-99**

-THT- Male Header right angle (side entry)

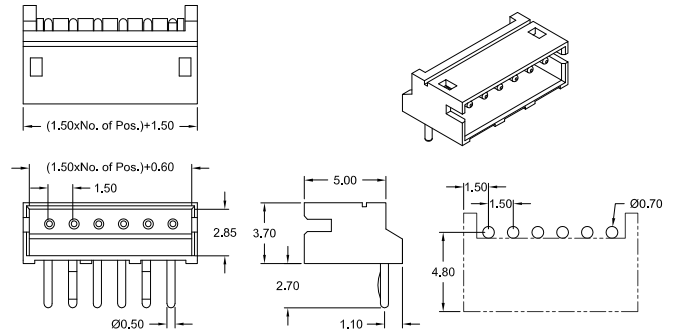

Order Code: **CRR-1xx-K150-99**

-THT- Male Header straight (top entry)

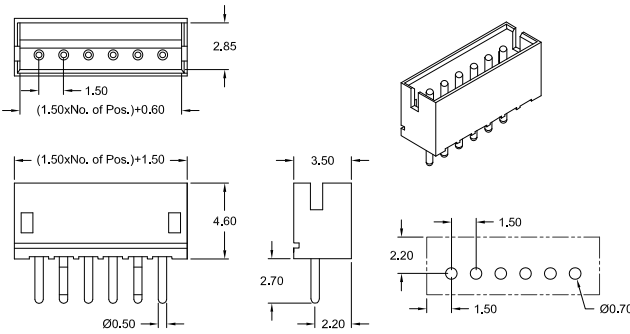

Order Code: **CRS-1xx-K150-99**

-SMT- Male Header right angle (side entry)

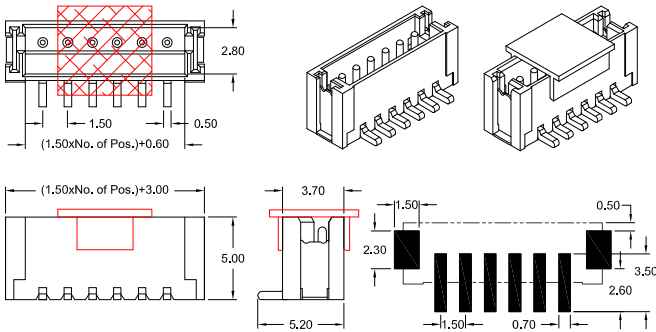

Order Code: **CRS-1xx-SK150-99/B**

-SMT- Male Header right angle (side entry)

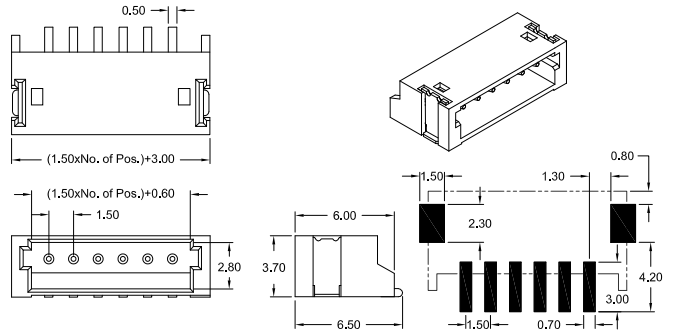

Order Code: **CRR-1xx-SK150-99/R**

Specifications

Current rating	1 A	Voltage rating	50 V AC max.	Contact material	Brass
Insulation resistance	500 MΩ min.	Withstanding voltage	500 V AC	Insulator material K150	PA66 UL 94V-0
Contact resistance	20 mΩ max.	Operating temperature	-25°C to +85°C	Insulator material SK150	PA9T UL 94V-0
		SMT Processing temp.	+250°C for 5 sec.	PCB thickness	1.60 mm

How to order

CR X - x xx - X 150 - 99 / X

Type	Rows	Nbr of Contacts	Execution	Plating	Packing
F = Female R = R/A Male S = Straight Male	1 = single row <i>if Crimp Contact:</i> 9	02 to 13 <i>if Crimp Contact:</i> (MOQ: 10K / reel) 99/35 = AWG 28~32	K = THT & Plug SK = SMT for details see above dwg's	99 = Tin (leadfree) other platings on request	R = Reel B = Reel with PickUp Cap

2.00mm Wire to Board Crimp Contact Connectors



O - Type Single Row

Female Plug

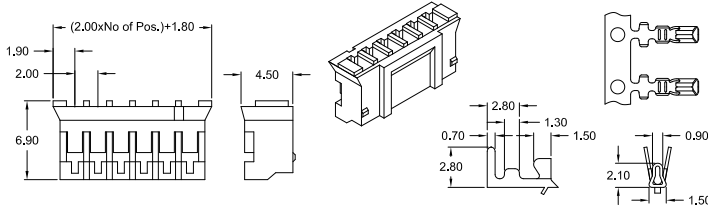

Order Code Housing: **CRF-1xx-O200**

Contact: **CRF-999/30-O200-99**

-THT- Male Header straight (top entry) & right angle (side entry)

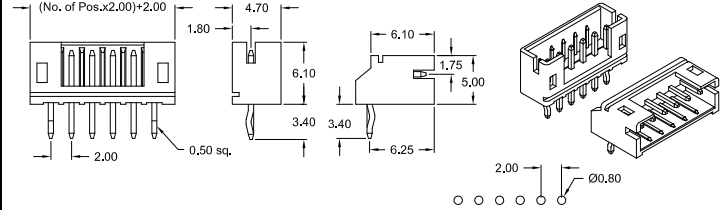

Order Code straight: **CRS-1xx-O200-99**

right angle: **CRR-1xx-O200-99**

H - Type Wire to Board Plugs mating with 2.00mm pitch Pin-Header

single row

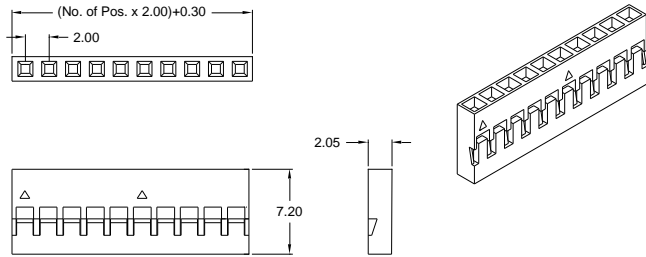

Order Code Housing: **CRF-1xx-H200**

dual row

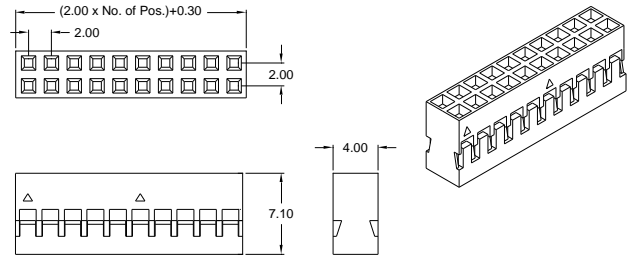

Order Code Housing: **CRF-2xx-H200**

Female Contact

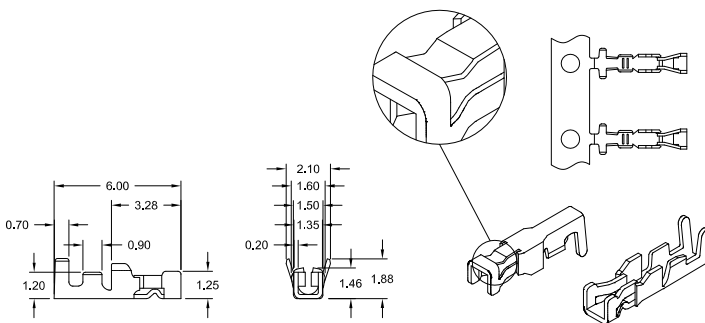

for single row 02 ~ 19 & dual row 04 ~ 18 position

Order Code: **CRF-999L/32-H200-55**

MOQ 10K / reel

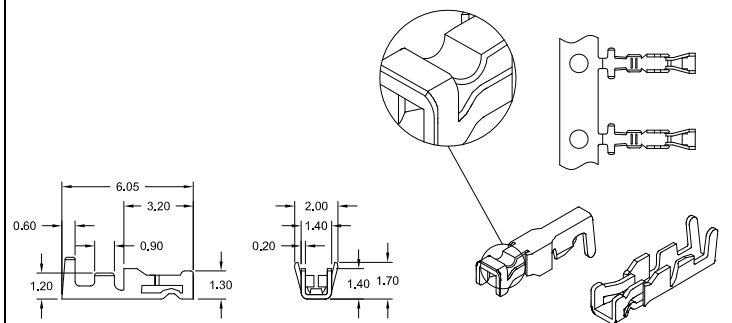

for single row 20 ~ 40 & dual row 20 ~ 80 position

Order Code: **CRF-999/32-H200-55**

MOQ 10K / reel

Specifications

Current rating	2 A	Voltage rating	100 V AC max.	Contact material	Copper Alloy
Insulation resistance	1000 MΩ min.	Withstanding voltage	800 V AC	Insulator material	PA66 UL 94V-0
Contact resistance	20 mΩ max.	Operating temperature	-25°C to +85°C	H-Type	PA66 UL 94V-2
				PCB thickness	1.60 mm

How to order

CR X - x xx - X 200 - 99

Type	Rows	Nbr of Contacts	Execution	Plating
F = Female	1 = single row	02 - 16 = O - Type	O = THT & Plug	99 = Tin <i>(leadfree)</i>
R = R/A Male	2 = dual row	02 - 40 = H - Type - 1 row	H = Plug	55 = Gold
S = Straight Male	<i>if Crimp Contact:</i> 9	<i>if Crimp Contact for O-Type:</i> 99/30 = for AWG 24~30	for details see above dwg's	other platings on request
		<i>if Crimp Contact for H-Type:</i> 99L/32 = for AWG 26~30 99/32 = for AWG 26~30		

2.00mm Wire to Board Crimp Contact Connectors



D - Type Dual Row

Female Plug

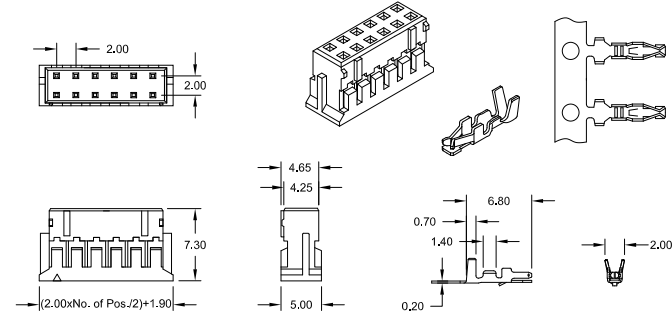

Order Code Housing: **CRF-2xx-D200**

Contact: **CRF-999/27-DP200-99**

-THT- Male Header

straight (top entry) & right angle (side entry)

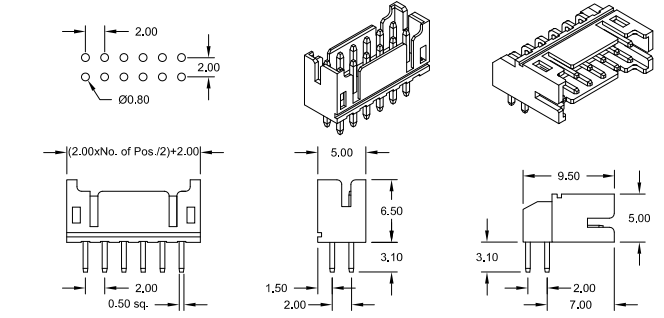

Order Code straight: **CRS-2xx-D200-99**

right angle: **CRR-2xx-D200-99**

C - Type Single Row

Female Plug

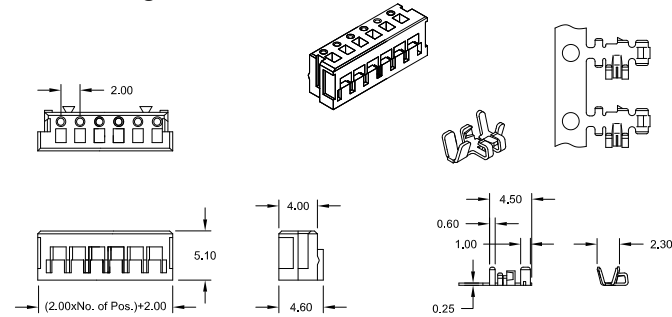

Order Code housing: **CRF-1xx-C200**

contact: **CRF-999/29-C200-99**

-SMT- Male Header

straight (top entry)

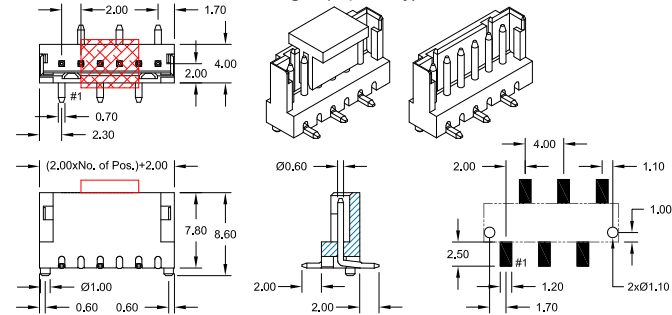

Order Code straight: **CRS-1xx-SC200-99/X**

-THT- Male Header

straight (top entry) & right angle (side entry)

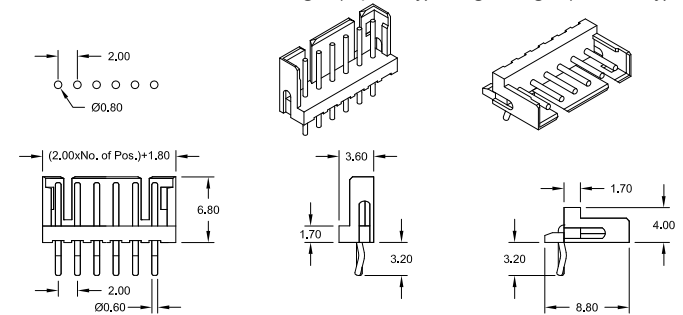

Order Code straight: **CRS-1xx-C200-99**

right angle: **CRR-1xx-C200-99**

Specifications

Current rating	2 A	Withstanding voltage	800 V AC	Contact material	Brass; DP = PhBz
Insulation resistance	1000 MΩ min.	Operating temperature	-25°C to +85°C	Insulator material	PA66 UL 94V-0
Contact resistance	20 mΩ max.	SC200 Type	-25°C to +105°C	SC200 Type	PA9T UL 94V-0
Voltage rating	100 V AC max.	SMT Processing temp.	+250°C for 5 sec.	PCB thickness	1.60 mm

How to order

CR X - x xx - X 200 - 99 / X

Type	Rows	Nbr of Contacts	Execution	Plating	Packing
F = Female R = R/A Male S = Straight Male	1 = single row 2 = dual row <i>if Crimp Contact:</i> 9	04 - 40 = D - Type 02 - 16 = C - Type 03 - 06 = SC - Type <i>if Crimp Contact: (MOQ: 10K / reel)</i> 99/27 = AWG 22~28 99/29 = AWG 24~28	D = THT & Plug DP <i>see Contact Material</i> C = THT & Plug SC = SMT for details see above dwg's	99 = Tin (<i>leadfree</i>) other platings on request	A = Tube with Pickup Cap B = Reel with Pickup Cap

2.00mm Wire to Board Crimp Contact Connectors



K - Type Single Row

female plug

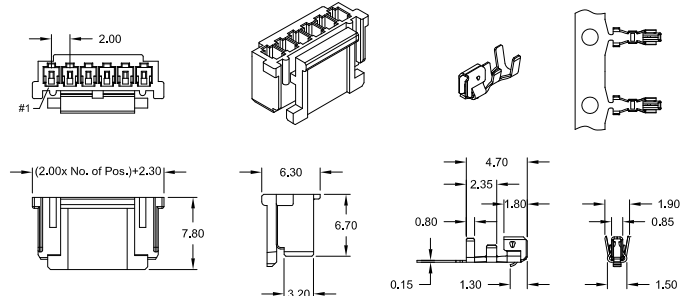

Order Code housing: CRF-1xx-K200

contact: CRF-999/30-K200-99

-SMT- male header right angle (side entry)

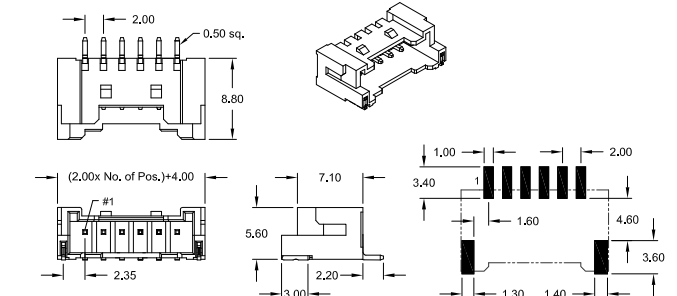

Order Code right angle: CRR-1xx-SK200-xx/X

P - Type Single Row

female plug

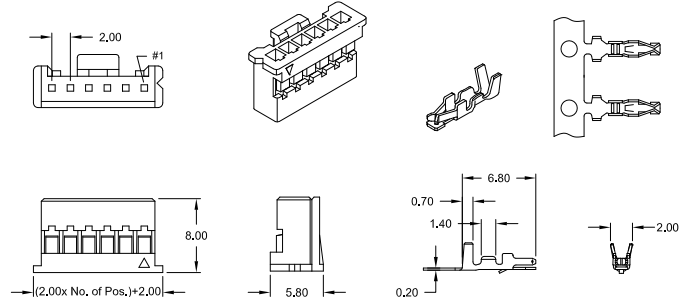

Order Code housing: CRF-1xx-P200

contact: CRF-999/27-DP200-xx

-THT- male header straight (top entry) & right angle (side entry)

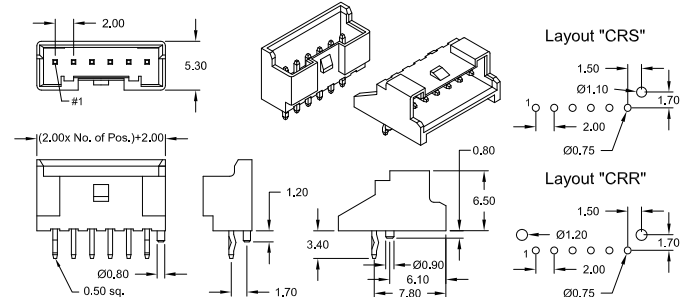

Order Code straight: CRS-1xx-P200-99/P

right angle: CRR-1xx-P200-xx/P

SH - Type Single Row

female plug

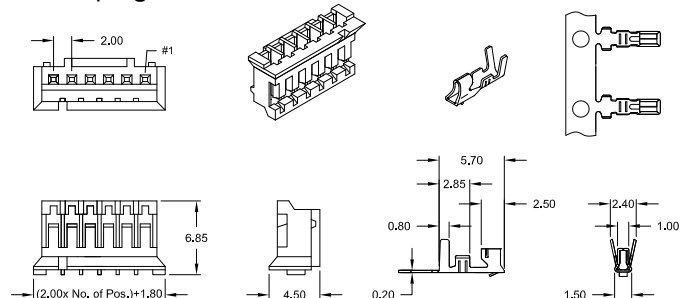

Order Code housing: CRF-1xx-SH200

contact: CRF-999/30-SH200-99

-SMT- male header straight (top entry) & right angle (side entry)

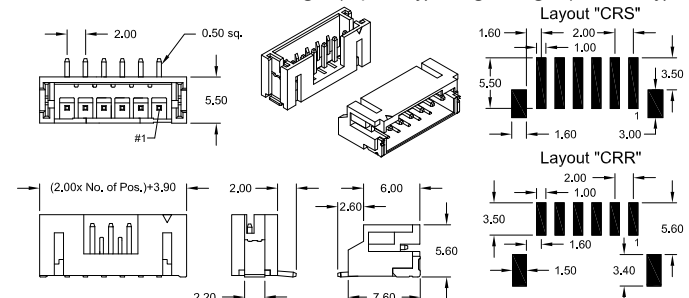

Order Code straight: CRS-1xx-SH200-99/X

right angle: CRR-1xx-SH200-99/X

Specification

Current rating	2 A	Operating temperature	-25°C to +85°C	Contact material	Copper Alloy
Insulation resistance	1000 MΩ min.	if PA6T	-40°C to +105°C	Insulator material	all UL 94 V-0
Contact resistance	20 mΩ max.	SMT Processing temp.	+250°C for 5 sec.	CRF-P; K & SH	PA66
Voltage rating	250 V AC max.			CRS- & CRR-P	PBT
Withstanding voltage	800 V AC			CRS-SH; CRR-SH	PA6T SK = PA9T

How to order

CR X - x xx - X 200 - xx /X

Type	Rows	Nbr of contacts	Execution	Plating	Packing
F = Female R = R/A male S = Straight male	1 = single row <i>if Crimp Contact:</i> 9	04 - 20 = K - Type 02 - 15 = P - Type 02 - 16 = SH - Type <i>if Crimp Contact: (MOQ: 10K / reel)</i> 99/27 = AWG 22~28 99/30 = AWG 24~30	K P SH SK DP for details see above dwg's	99 = Tin <i>(leadfree)</i> 55 = Gold other platings on request	<i>only if SMT Type</i> /B = Reel with Pickup Cap /R = Reel w/o Pickup Cap

2.50mm Wire to Board Crimp Contact Connectors



S - Type Single Row

Female Plug

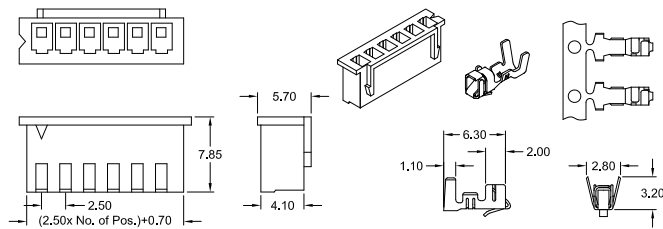

Order Code Housing: **CRF-1xx-S250**

Contact: **CRF-999/27-S250-99**

-THT- Male Header straight (top entry) & right angle (side entry)

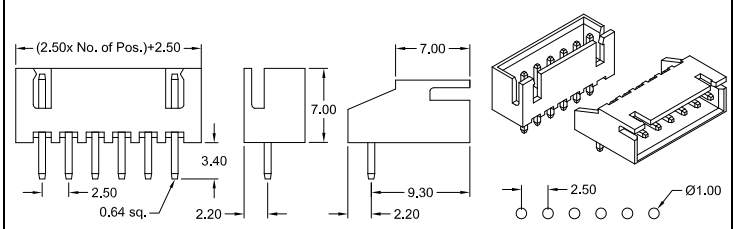

Order Code straight: **CRS-1xx-S250-99**

right angle: **CRR-1xx-S250-99**

I - Type Single Row

Female Plug

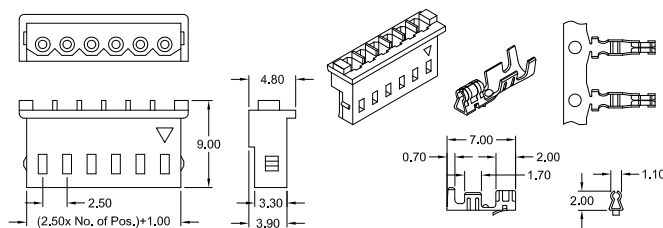

Order Code Housing: **CRF-1xx-I250**

contact: **CRF-999/27-I250-99**

-THT- Male Header straight (top entry) & right angle (side entry)

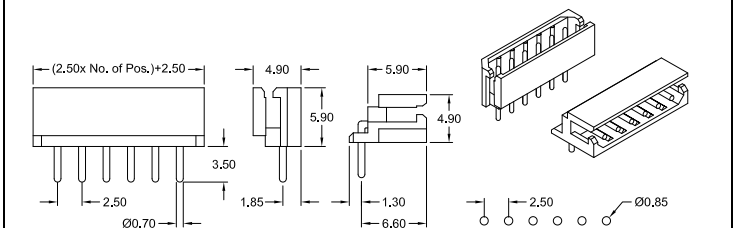

Order Code straight: **CRS-1xx-I250-99**

right angle: **CRR-1xx-I250-99**

R - Type Single Row

Female plug

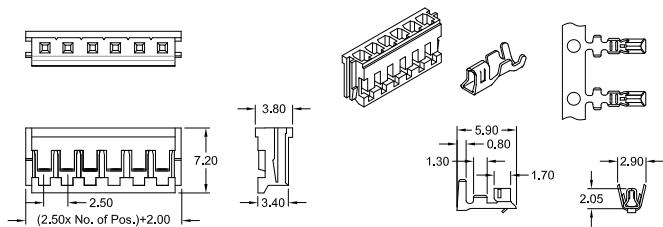

Order Code Housing: **CRF-1xx-R250**

Contact: **CRF-999/28-R250-99**

-THT- Male Header straight (top entry) & right angle (side entry)

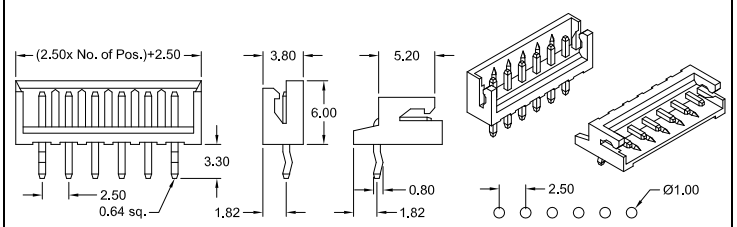

Order Code straight: **CRS-1xx-R250-99**

right angle: **CRR-1xx-R250-99**

Specifications

Current rating	3 A	Voltage rating	250 V AC max.	Contact material	Copper Alloy
Insulation resistance	1000 MΩ min.	Withstanding voltage	1000 V AC	Insulator material	PA66 UL 94V-0
Contact resistance	20 mΩ max.	Operating temperature	-25°C to +85°C	PCB thickness	1.60 mm

How to order

CR X - x xx - X 250 - 99

Type	Rows	Nbr of Contacts	Execution	Plating
F = Female R = R/A male S = Straight male	1 = single row <i>if Crimp Contact:</i> 9	02 - 20 = S - Type 02 - 15 = I & R - Type <i>if Crimp Contact:</i> (MOQ: 10K / reel) <i>for S- & I-Type:</i> 99/27 = for AWG 22~28 <i>for R-Type:</i> 99/28 = for AWG 22~30	S = THT & Plug I = THT & Plug R = THT & Plug for details see above dwg's	99 = Tin <i>(leadfree)</i> other platings on request

2.54mm Wire to Board Crimp Contact Connectors



UT - Type Single Row

<p>Female Plug</p> <p>Order Code Housing: CRF-1xx-UT254 Contact: CRF-999/27-UT254-99</p>	<p>-THT- Male Header straight & right angle</p> <p>Order Code straight: CRS-1xx-UT254-99 right angle: CRR-1xx-UT254-99</p>
--	---

P - Type "Friction Lock" Single Row

<p>Female Plug</p> <p>Order Code Housing: CRF-1xx-P254 Contact: CRF-999/27-P254-99</p>	<p>-THT- Male Header straight & right angle</p> <p>Order Code straight: CRS-1xx-P254-99 right angle: CRR-1xx-P254-99</p>
--	---

-SMT- Male Header straight

Order Code: **CRS-1xx-SP254-99/A (Tube)** **CRS-1xx-SP254-99/B (Reel)**

Specifications

Current rating	3 A	Voltage rating	250 V AC max.	Contact material	Copper Alloy
Insulation resistance	1000 MΩ min.	Withstanding voltage	1500 V AC	Insulator material	PA 66 (brown) UL 94V-0
Contact resistance	20 mΩ max.	Operating temperature	-25°C to +85°C	CRF-UT Type	PBT (brown) UL 94V-0
		SMT Processing temp.	+250°C for 5 sec.	CRS(R)-UT Type	PA 66 (black) UL 94V-0
				SP Type	PA 46 (white) UL 94V-0

How to order

CR X - x xx - X 254 - 99

Type	Rows	Nbr of Contacts	Execution	Plating
F = Female R = R/A Male S = Straight Male	1 = single row <i>if Crimp Contact:</i> 9	02 - 20 = UT & P - Type 02 - 12 = SP - Type <i>if Crimp Contact:</i> 99/27 = MOQ: 10K / reel for AWG 22~28	UT = Plug & THT P = Plug & THT SP = SMT for details see above dwg's	99 = Tin <i>(leadfree)</i> other platings on request

2.54mm Wire to Board Crimp Contact Connectors



F - Type Single Row

Female Plug

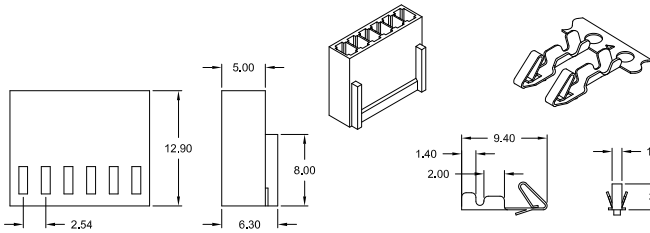

Order Code Housing: **CRF-1xx-F254**

Contact: **CRF-999/28-F254-99**

-THT- Male Header straight & right angle

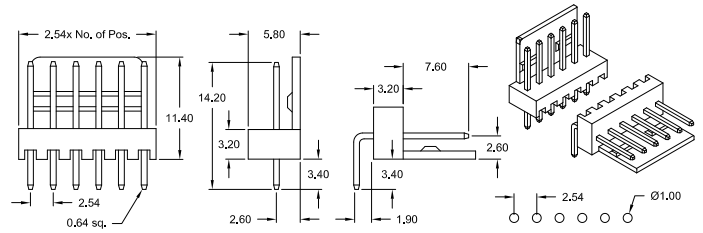

Order Code straight: **CRS-1xx-F254-99**

right angle: **CRR-1xx-F254-99**

H - Type Wire to Board Plugs mating with 2.54mm pitch Pin- / Box-Header

single row - without bump -

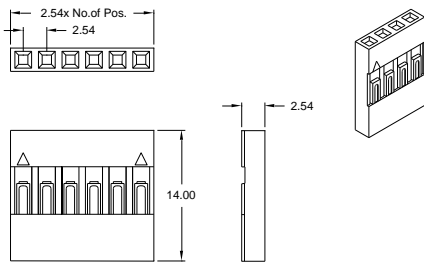

Order Code Housing: **CRF-1xx-H254**

dual row - without bump -

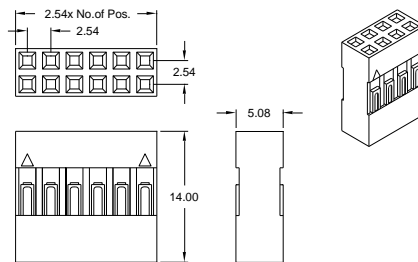

Order Code Housing: **CRF-2xx-H254**

dual row - with high bump -

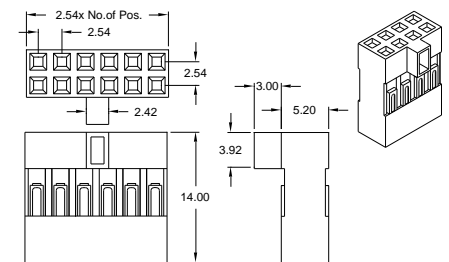

Order Code Housing: **CRF-2xx-H254/HP**

Female Contact

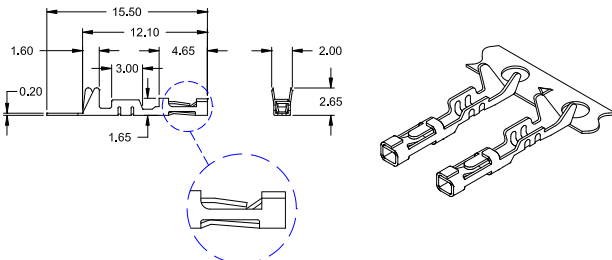

for single row 01 ~ 19 & dual row 06 ~ 18 position

Order Code: **CRF-999L/27-H254-95**

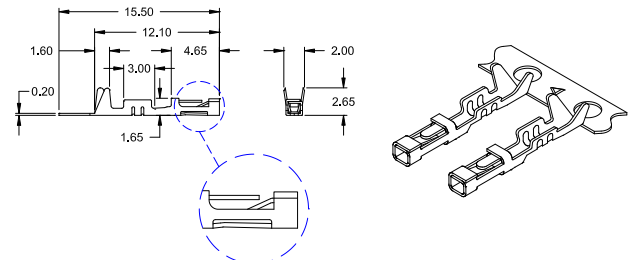

for single row 20 ~ 40 & dual row 20 ~ 80 position

Order Code: **CRF-999/27-H254-95**

Specifications

Current rating	3 A
Insulation resistance	1000 MΩ min.
Contact resistance	20 mΩ max.

Withstanding voltage	800 V AC
Voltage rating	250 V AC/DC
Operating temp.	-25°C to +85°C
Contact material	Copper Alloy

Insulator material	F-Type PA66 UL 94V-2
H Type 1-row: 01 - 40 Pos.	NORYL UL 94V-1
H Type 2-row: 06 - 80 Pos.	NORYL UL 94V-1

How to order

CR X - x xx - X 254 - xx

Type	Rows	Nbr of Contacts	Execution	Plating
F = Female R = R/A Male S = Straight Male	1 = single row 2 = dual row if Crimp Contact: 9	02 - 20 = F - Type (except 19) 01 - 40 = H - Type - 1 row 04 - 80 = H - Type - 2 row if without bump 06 - 80 = H - Type - 2 row if with bump if Crimp Contact: (MOQ: 10K / reel) for F - Type: 99/28 = for AWG 22~30 for H - Type: 99X/27 = for AWG 22~28	F = THT & Plug H = Plug for details see above drawings	99 = Tin 95 = Tin/Gold



W - Type Single Row fully shrouded with polarity protection

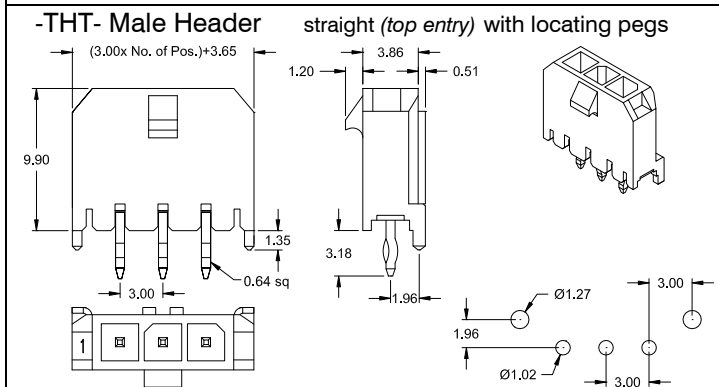

Order Code: **PCS-1xx-W300-99**

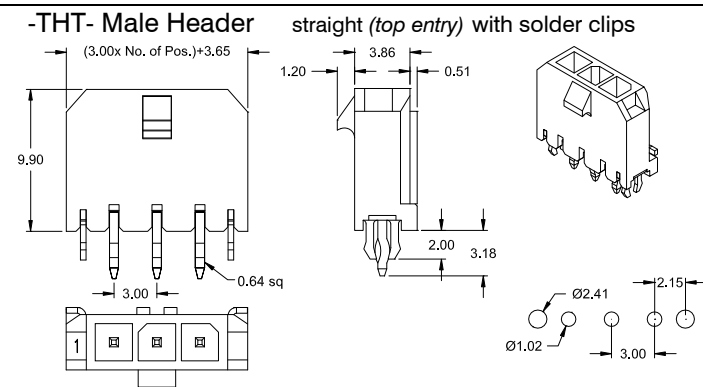

Order Code: **PCS-1xx-WC300-99**

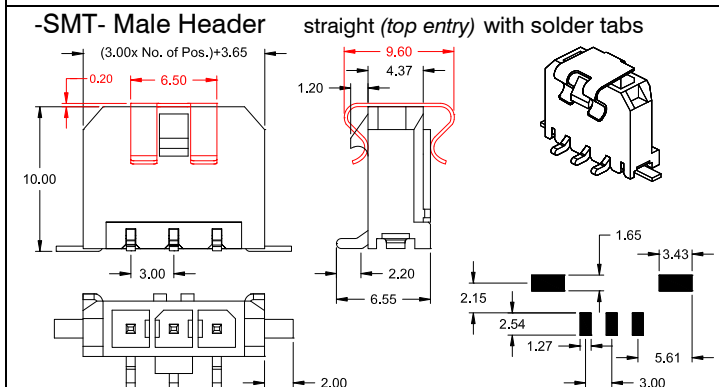

Order Code: **PCS-1xx-SW300-99/B**

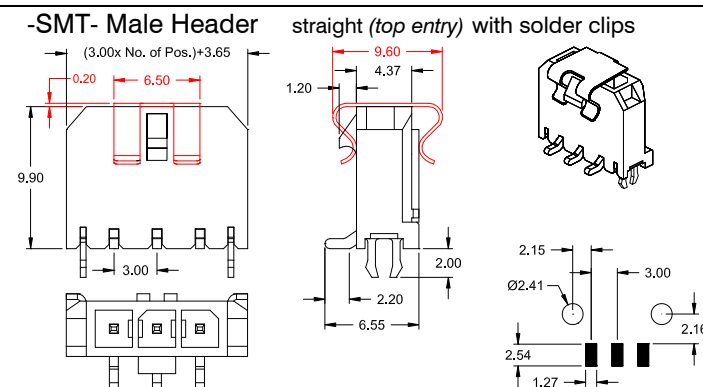

Order Code: **PCS-1xx-SC300-99/XX** (/B = Standard /LB = Option)

W - Type Female Plug Single Row -Clip lock Type- with polarity protection

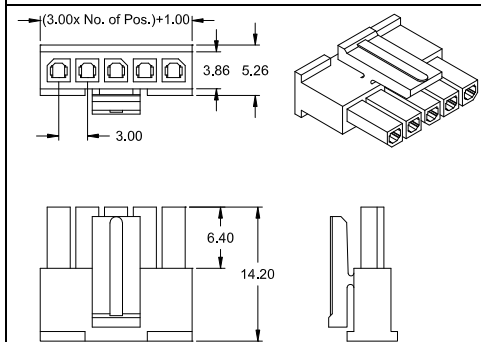

Order Code Housing: **PCF-1xx-W300**

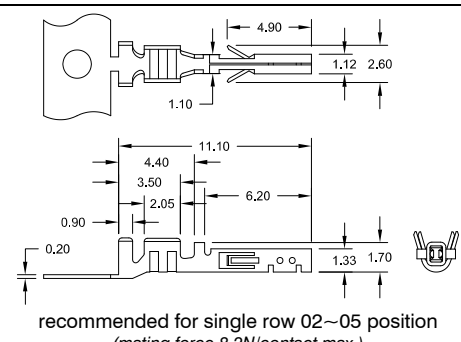

Order Code Contact: **PCF-999/xx-W300-99**

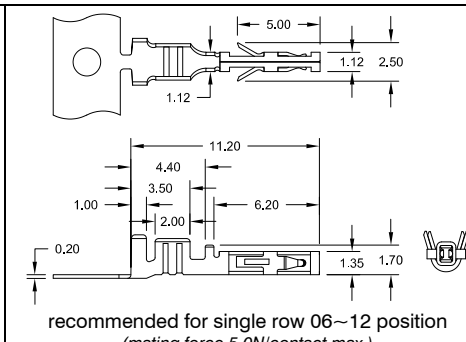

Order Code Contact: **PCF-999/xxL-W300-99**

Specifications

Current rating	5 A if AWG 20	Withstanding voltage	1500 V AC	Contact material	Copper Alloy
Insulation resistance	1000 MΩ min.	Operating temp.	-40°C to +105°C	Insulator material	LCP UL 94V-0
Contact resistance	10 mΩ max.	SMT Processing temp.	+250°C for 5 sec.	PCF Plug	PA66 UL 94V-0
Voltage rating	250 V AC max.	PCB thickness			1.60 mm

How to order

PC X - x xx - X 300 - 99 / X

Type	Rows	Nbr of Contacts	Execution	Plating	Option
F = Female R = R/A Male S = Straight Male	1 = single row if Crimp Contact: 9	02 - 12 = W, WC, SW, SC - Type if Crimp Contact: (MOQ: 10K / reel) 99/22 = for AWG 20~24 99/22L = for AWG 20~24 99/32 = for AWG 26~30 99/32L = for AWG 26~30	W = THT & Plug WC = THT SW = SMT SC = SMT for details see above dwg's	99 = Tin (leadfree) other platings on request	B = Reel packing with Pickup Cap -SC300- & -WC300- only: LB = solder clip length 3.20mm; Reel packing with Pickup Cap



W - Type Single Row fully shrouded with polarity protection

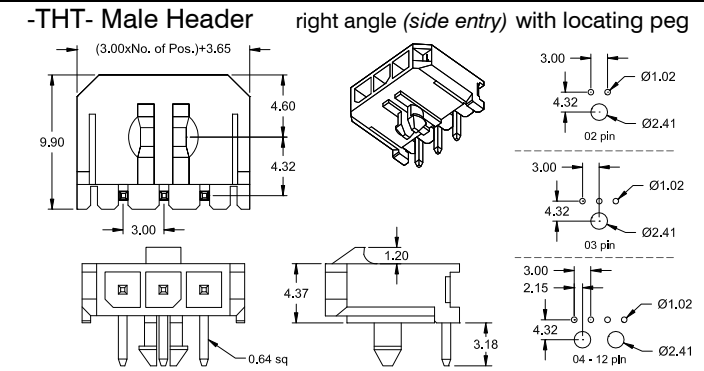

Order Code: **PCR-1xx-W300-99**

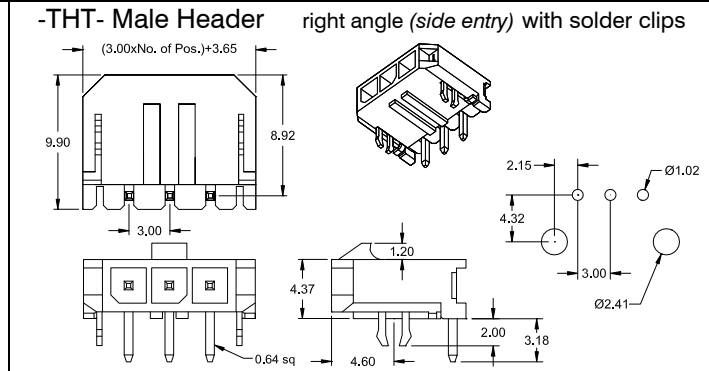

Order Code: **PCR-1xx-WC300-99** (/L = Option)

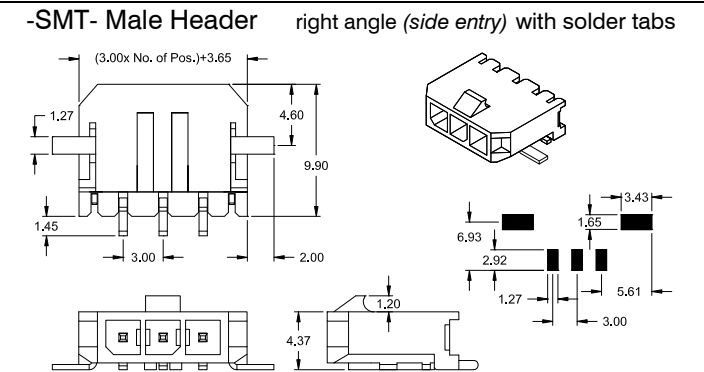

Order Code: **PCR-1xx-SW300-99/R**

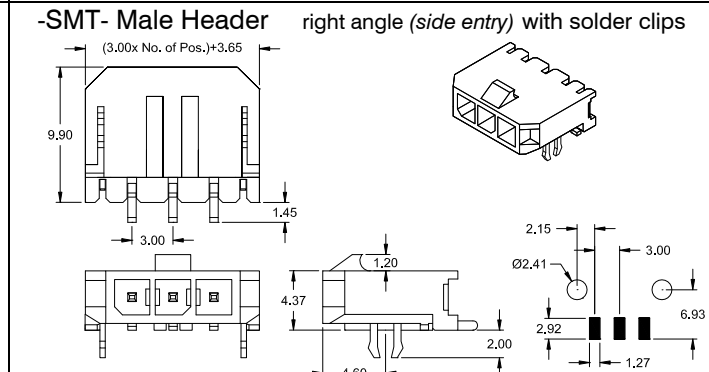

Order Code: **PCR-1xx-SC300-99/X** (/R = Standard /LR = Option)

W - Type Male Plug Single Row -Clip lock Type- with polarity protection

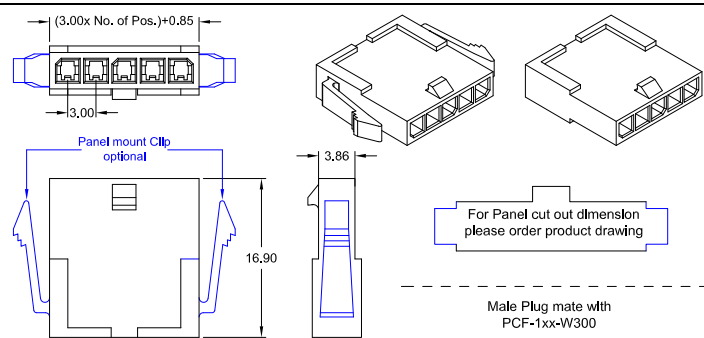

Order Code Housing without Panel mount Clip: **PCM-1xx-WN300**
 Order Code Housing with Panel mount Clip: **PCM-1xx-W300**

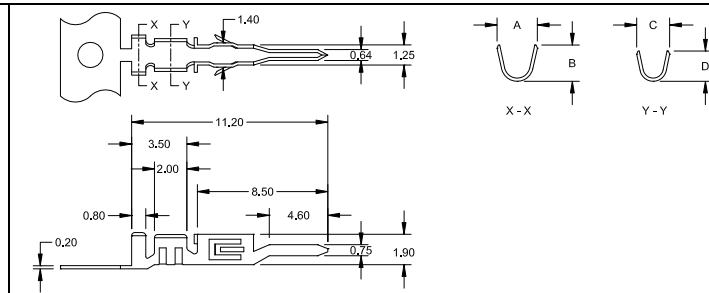

Crimp Contact Order Code	Wire range	Dimension mm			
		A	B	C	D
PCM-999/22-W300-99	AWG 20 ~ 24	2.70	2.40	2.10	2.10
PCM-999/32-W300-99	AWG 26 ~ 30	2.40	1.90	1.80	1.60

Specifications

Current rating	5 A if AWG 20	Withstanding voltage	1500 V AC	Contact material	Phosphor Bronze
Insulation resistance	1000 MΩ min.	Operating temp.	-40°C to +105°C	Insulator material	LCP UL 94V-0
Contact resistance	10 mΩ max.	SMT Processing temp.	+250°C for 5 sec.	PCM Type	PA66 UL 94V-0
Voltage rating	250 V AC max.			PCB thickness	1.60 mm

How to order

PC X - x xx - X 300 - 99 / X

Type	Rows	Nbr of Contacts	Execution	Plating	Option
M = Male R = R/A Male S = Straight Male	1 = single row if Crimp Contact: 9	02 to 12 if Crimp Contact: (MOQ: 10K / reel) 99/22 = for AWG 20~24 99/32 = for AWG 26~30	W = THT & Plug WC = THT WN = Plug SC = SMT SW = SMT for details see above dwg's	99 = Tin (leadfree) other platings on request	R = Reel packing -SC300- & -WC300- only: L = solder clip length 3.20mm



W - Type Dual Row fully shrouded with polarity protection

<p>-THT- Male Header straight (top entry)</p> <p>Order Code: PCS-2xx-W300-99</p>	<p>-THT- Male Header right angle (side entry)</p> <p>Order Code: PCR-2xx-W300-99</p>
--	--

<p>-SMT- Male Header straight (top entry) with solder tabs</p> <p>Order Code: PCS-2xx-SW300-99/B</p>	<p>-SMT- Male Header straight (top entry) with solder clips</p> <p>Order Code: PCS-2xx-SC300-99/XX (/B = Standard /LB = Option)</p>
--	---

W - Type Female Plug Dual Row -Clip lock Type- with polarity protection

<p>Order Code Housing: PCF-2xx-W300</p>	<p>recommended for dual row 02~10 position (mating force 8,2N/contact max.)</p> <p>Order Code Contact: PCF-999/xx-W300-99</p>	<p>recommended for dual row 12~24 position (mating force 5,0N/contact max.)</p> <p>Order Code Contact: PCF-999/xxL-W300-99</p>
--	--	---

Specifications

Current rating	5 A if AWG #20	Withstanding voltage	1500 V AC	Contact material	Copper Alloy
Insulation resistance	1000 MΩ min.	Operating temp.	-40°C to +105°C	Insulator material	PCF PA66 UL 94V-0
Contact resistance	10 mΩ max.	SMT Processing temp.	+250°C for 5 sec.	PCS & PCR	PA9T UL 94V-0
Voltage rating	250 V AC max.			SW & SC Type	LCP UL 94V-0
				PCB thickness	1.60 mm

How to order

PC X - x xx - X 300 - 99 / X

Type	Rows	Nbr of Contacts	Execution	Plating	Option
F = Female R = R/A Male S = Straight Male	2 = dual row if Crimp Contact: 9	02 - 24 = W, SW, SC - Type if Crimp Contact: (MOQ: 10K / reel) 99/22 = for AWG 20~24 99/22L = for AWG 20~24 99/32 = for AWG 26~30 99/32L = for AWG 26~30	W = THT & Plug SW = SMT SC = SMT for details see above dwg's	99 = Tin (leadfree) other platings on request	B = Reel packing with PickUp Cap PCS-2xx-SC300-99/XX only: LB = solder clip length 3.20mm; Reel packing with PickUp Cap



W - Type Dual Row fully shrouded with polarity protection

-SMT- Male Header right angle (side entry) with solder tabs

Order Code: PCR-2xx-SW300-99/R

-SMT- Male Header right angle (side entry) with solder clips

Order Code: PCR-2xx-SC300-99/X (/R = Standard /LR = Option)

W - Type Male Plug Dual Row -Clip lock Type- with polarity protection

Order Code Housing without Panel mount Clip: PCM-2xx-WN300
 Order Code Housing with Panel mount Clip: PCM-2xx-W300

Crimp Contact Order Code	Wire range	Dimension mm			
		A	B	C	D
PCM-999/22-W300-99	AWG 20 ~ 24	2.70	2.40	2.10	2.10
PCM-999/32-W300-99	AWG 26 ~ 30	2.40	1.90	1.80	1.60

Specifications

Current rating	5 A if AWG 20	Withstanding voltage	1500 V AC	Contact material	Phosphor Bronze
Insulation resistance	1000 MΩ min.	Operating temp.	-40°C to +105°C	Insulator material	LCP UL 94V-0
Contact resistance	10 mΩ max.	SMT Processing temp.	+250°C for 5 sec.	PCM Type	PA66 UL 94V-0
Voltage rating	250 V AC max.	PCB thickness			1.60 mm

How to order

PC X - x xx - X 300 - 99 / X

Type	Rows	Nbr of Contacts	Execution	Plating	Option
M = Male R = R/A Male	2 = dual row if Crimp Contact: 9	04 to 24 if Crimp Contact: (MOQ: 10K / reel) 99/22 = for AWG 20~24 99/32 = for AWG 26~30	W = Plug WN = Plug SC = SMT SW = SMT for details see above dwg's	99 = Tin (leadfree) other platings on request	R = Reel packing PCR-2xx-SC300-99/X only: L = solder clip length 3.20mm

BF - Type Female Plug Dual Row with polarity protection

-THT- straight

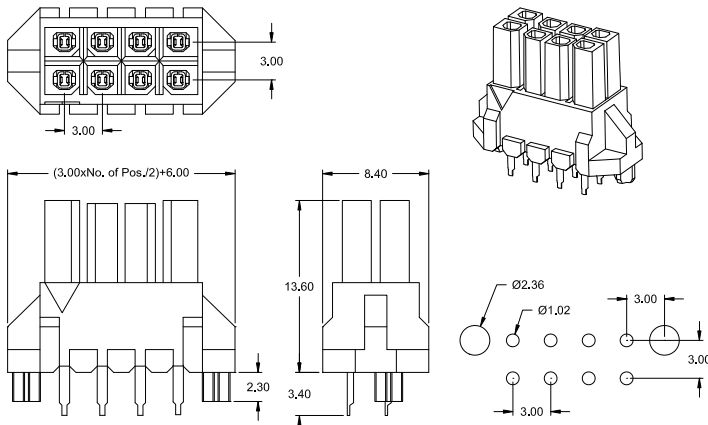

Order Code: **PCS-2xx-BF300-99**

-THT- right angle

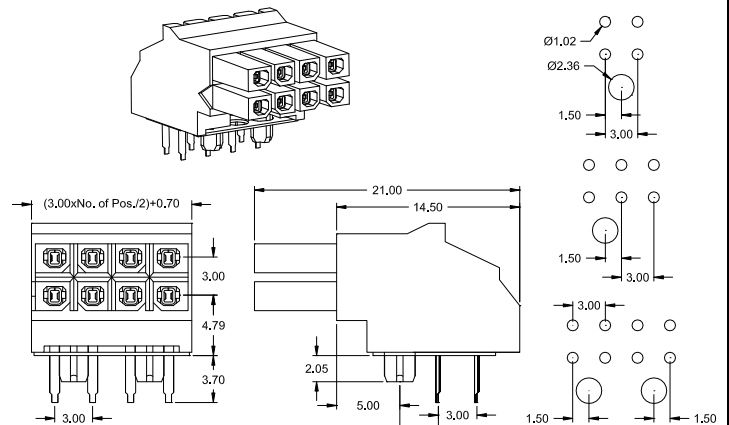

Order Code: **PCR-2xx-BF300-99**

BM - Type Male Header Dual Row fully shrouded with polarity protection

-THT- straight (top entry)

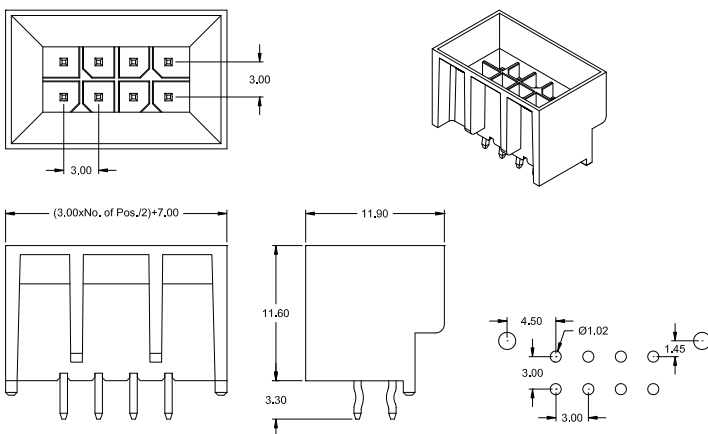

Order Code: **PCS-2xx-BM300-99**

-THT- right angle (side entry)

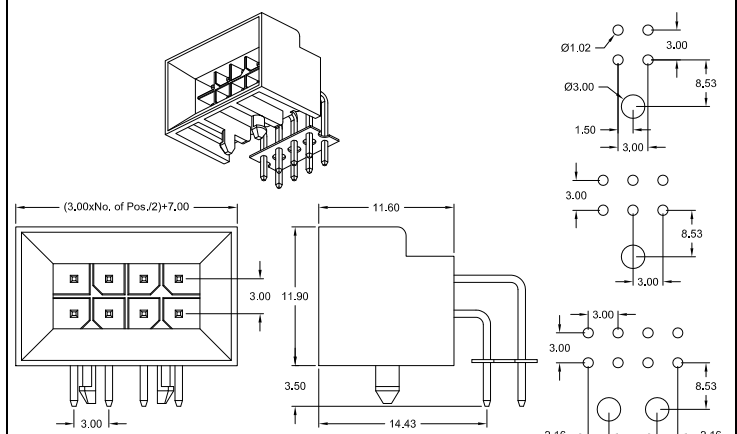

Order Code: **PCR-2xx-BM300-99**

Specification

Current rating	5 A	Voltage rating	250 V AC max.	Contact material	Copper alloy
Insulation resistance	1000 MΩ min.	Withstanding voltage	1500 V AC	Insulator material	LCP UL 94V-0
Contact resistance	10 mΩ max.	Operating temp.	-40°C to +105°C	PCB thickness	1.60 mm

How to order

PC X - 2 xx - XX 300 - 99

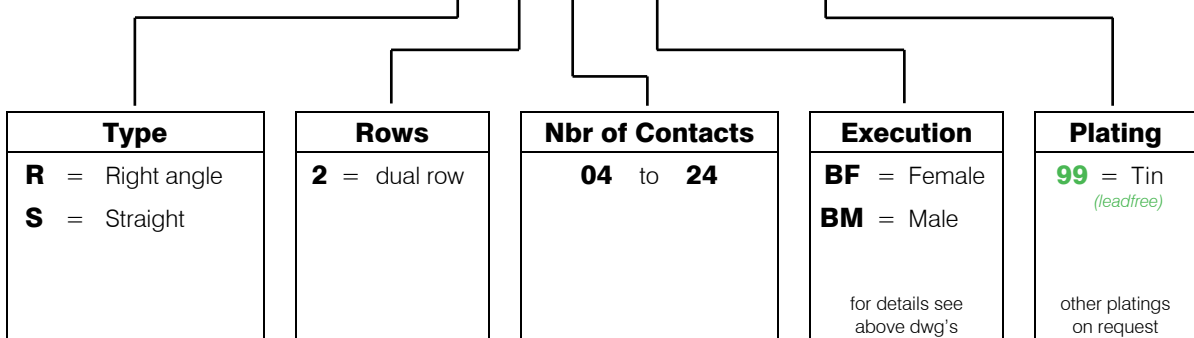

Crimp Contact & IDC Power Connectors

F - Type "Friction Lock" Single Row

Female Plug

AWG 18~24

-THT- Male Header straight & right angle

Order Code Housing: **PCF-1xx-F396** Contact: **PCF-999/20-F396-99** Order Code straight: **PCS-1xx-F396-99** right angle: **PCR-1xx-F396-99**

Q - Type "Quick Lock" Single Row

Female Plug

-THT- Male Header straight & right angle

Order Code Housing: **PCF-1xx-Q396** Contact: **PCF-999/xx-Q396-99** Order Code straight: **PCS-1xx-Q396-99** right angle: **PCR-1xx-Q396-99**

P - Type IDC "Friction Lock" Single Row

Female Plug

Wire range	Suffix
AWG #18	/M
AWG #20	/N
AWG #22	/P
AWG #24	/Q

Order Code Strain Relief: SRC-1xx-P396/N

"open" Type "closed" Type

-THT- Male Header straight & right angle

Order Code: **IDF-1xx/X-P396-99** **IDF-1xx/X-PC396-99** Order Code straight: **PCS-1xx-P396-99** right angle: **PCR-1xx-P396-99**

Specifications

Current rating F- & Q-Type 7 A P-Type 4 A (UL) 5A (CSA)	Voltage rating 250 V AC max. Withstanding voltage 1500 V AC Operating temperature -20°C to +85°C	Contact material Copper Alloy Insulator material PA66 UL 94V-2 Q Type PA66 UL 94V-0 PCB thickness 1.60 mm
Insulation resistance 1000 MΩ min.		
Contact resistance 20 mΩ max.		

How to order

XXX - x xx - X 396 - 99

Type

PCF = Female
PCR = R/A Male
PCS = Straight Male
IDF = IDC Female

Rows

1 = single row

if Crimp Contact:
9

Nbr of Contacts

02 - 16 = F - Type
02 - 28 = P - Type
02 - 15 = Q - Type

if Crimp Contact for Q-Type:
99/19 = for AWG 18~22
99/16 = for AWG 16~20

MOQ: F-Type = 6K / reel
Q-Type = 4K / reel

Execution

F = Friction Lock Type
P = IDC "open" Type
PC = IDC "closed" Type
Q = Quick Lock Type

for details see above dwg's

Plating

99 = Tin (leadfree)

other platings on request



P - Type Single Row fully shrouded with polarity protection

-THT- Male Header straight (top entry) with & w/o board lock clips

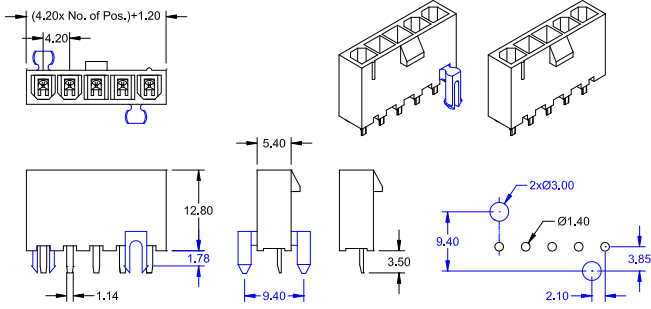

Order Code: PCS-1xx-P420-99

PCS-1xx-PN420-99

-THT- Male Header right angle (side entry) with board lock clips

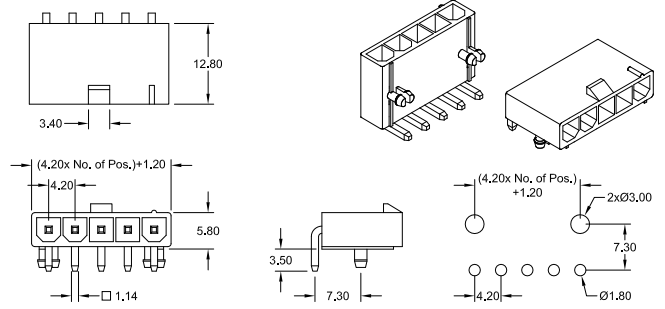

Order Code: PCR-1xx-P420-99

-THT- Male Header right angle (side entry)

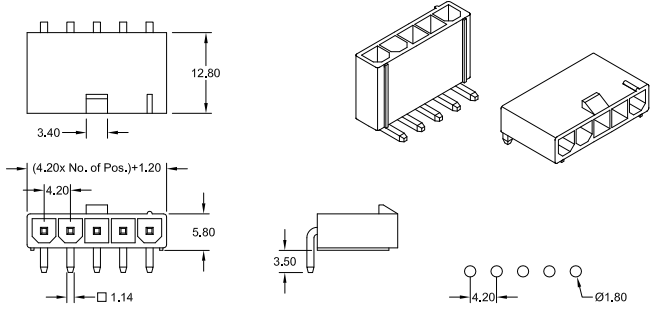

Order Code: PCR-1xx-A420-99

-THT- Male Header right angle (side entry) with mounting ears

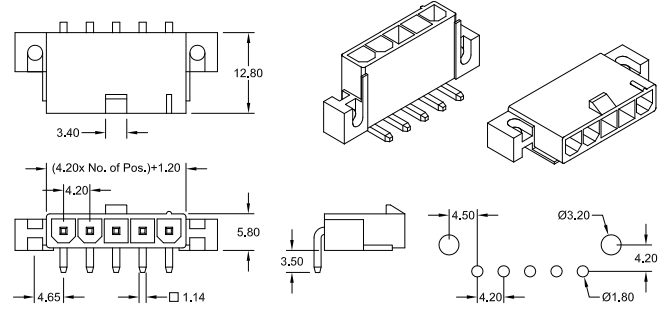

Order Code: PCR-1xx-W420-99

P - Type Female Plug Single Row -Clip lock Type- with polarity protection

mate with -P420-, -A420- & -W420- Male Header

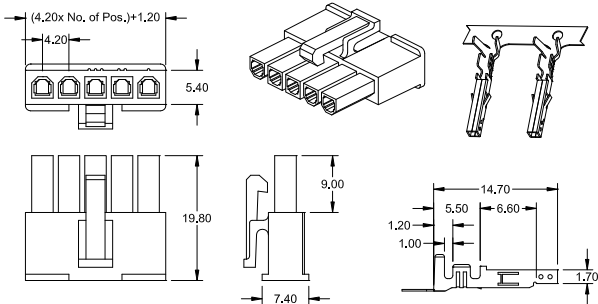

Order Code Housing: PCF-1xx-P420

Contact: PCF-999/xxX-P420-99

Current rating @30°C:
(dependant on number of contacts and wire size)

Wire Size AWG	Contacts			
	02 ~ 03	04 ~ 06	07 ~ 10	11 ~ 12
#16	9A	8A	7A	6A
#18	9A	8A	7A	6A
#20	7A	6A	5A	5A
#22	5A	4A	4A	4A
#24	4A	3A	3A	3A
#26	3A	2A	2A	2A
#28	2A	1A	1A	1A

Specifications

Current rating	pls. see box above	Voltage rating	600 V AC/DC	Contact material	Brass or PhBz
Insulation resistance	1000 MΩ min.	Withstanding voltage	1500 V AC	Insulator material	PA66 UL 94V-2
Contact resistance	20 mΩ max.	Operating temperature	-25°C to +85°C	PCB thickness	1.60 mm

How to order

PC X - x xx - X 420 - 99

Type	Rows	Nbr of Contacts	Execution	Plating
F = Female R = R/A Male S = Straight Male	1 = single row <i>if Crimp Contact:</i> 9	02 - 12 = P, A & W - Type <i>if Crimp Contact:</i> (MOQ: 5K / reel) <i>if Brass:</i> 99/27 = for AWG 22~28 99/20 = for AWG 18~24 99/14 = for AWG 16 <i>if Phosphor Bronze:</i> 99/27P = for AWG 22~28 99/20P = for AWG 18~24 99/14P = for AWG 16	P = with board lock clips PN = without board lock clips A = without mounting ears W = with mounting ears for details see above dwg's	99 = Tin (leadfree) other platings on request

P - Type Dual Row fully shrouded with polarity protection

-THT- Male Header straight (top entry) with board lock clips

Order Code: **PCS-2xx-P420-99**

-THT- Male Header straight (top entry) without board lock clips

Order Code: **PCS-2xx-PN420-99**

-THT- Male Header right angle (side entry) with mounting ears

Order Code: **PCR-2xx-W420-99**

-THT- Male Header right angle (side entry) with board lock clips

Order Code: **PCR-2xx-P420-99**

P - Type Female Plug Dual Row -Clip lock Type- with polarity protection

mate with -P420- & -W420- Male Header

Order Code Housing: **PCF-2xx-P420** Contact: **PCF-999/xxX-P420-99**

Current rating @30°C:
(dependant on number of contacts and wire size)

Wire Size	Contacts			
	02	04 & 06	08 & 10	12 ~ 24
#18	9A	8A	7A	6A
#20	7A	6A	5A	5A
#22	5A	4A	4A	4A
#24	4A	3A	3A	3A
#26	3A	2A	2A	2A
#28	2A	1A	1A	1A

Specifications

Current rating	pls. see box above	Voltage rating	600 V AC/DC	Contact material	Brass or PhBz
Insulation resistance	1000 MΩ min.	Withstanding voltage	1500 V AC	Insulator material	PA66 UL 94V-2
Contact resistance	20 mΩ max.	Operating temperature	-25°C to +85°C	PCB thickness	1.60 mm

How to order

PC X - x xx - X 420 - 99

Type	Rows	Nbr of Contacts	Execution	Plating
F = Female R = R/A Male S = Straight Male	2 = dual row <i>if Crimp Contact:</i> 9	02 - 24 = P & W - Type <i>if Crimp Contact:</i> (MOQ: 5K / reel) <i>if Brass:</i> 99/27 = for AWG 22~28 99/20 = for AWG 18~24 99/14 = for AWG 16 <i>if Phosphor Bronze:</i> 99/27P = for AWG 22~28 99/20P = for AWG 18~24 99/14P = for AWG 16	P = with board lock clips PN = without board lock clips W = with mounting ears for details see above dwg's	99 = Tin (leadfree) other platings on request

Crimp Contact "Power Connectors"

P - Type Male Plug Single & Dual Row

Single Row Housing with & without -Panel Clip lock-mate with PCF-1xx-P420

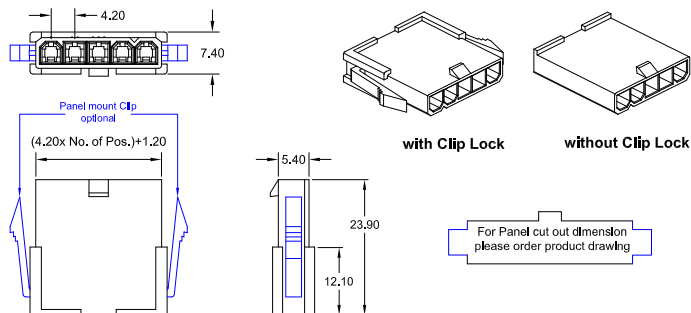

Order Code with Panel Clip lock: **PCM-1xx-P420**
 Order Code without Panel Clip lock: **PCM-1xx-PN420**

Dual Row Housing with & without -Panel Clip lock-mate with PCF-2xx-P420

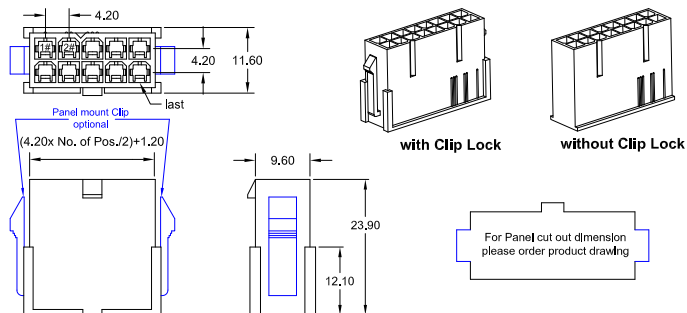

Order Code with Panel Clip lock: **PCM-2xx-P420**
 Order Code without Panel Clip lock: **PCM-2xx-PN420**

Male Contact

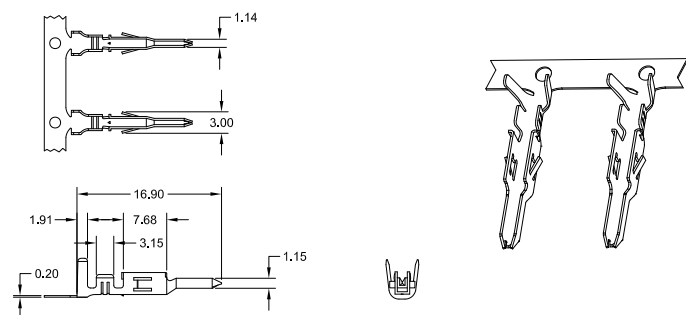

Order Code: **PCM-999/xxX-P420-99**

Current rating @30°C:
 (dependant on number of contacts and wire size)

Wire Size AWG	Contacts			
	02 ~ 03	04 ~ 06	07 ~ 10	11 ~ 24
#16	9A	8A	7A	6A
#18	9A	8A	7A	6A
#20	7A	6A	5A	5A
#22	5A	4A	4A	4A
#24	4A	3A	3A	3A
#26	3A	2A	2A	2A
#28	2A	1A	1A	1A

Specifications

Current rating	pls. see box above	Voltage rating	600 V AC max.	Contact material	Copper alloy
Insulation resistance	1000 MΩ min.	Withstanding voltage	1500 V AC	Insulator material	PA66 UL 94V-2
Contact resistance	20 mΩ max.	Operating temp.	-40°C to +105°C	PCB Thickness	2.00 mm max.

How to order

PCM - x xx - X 420 - 99

Rows

1 = single row
2 = dual row

if Crimp Contact:

9

Nbr of Contacts

02 - 12 = P & PN – Type single row
02 - 24 = P & PN – Type dual row

if Crimp Contact: (MOQ: 5K / reel)
if Brass (standard):
99/27 = for AWG 22~28
99/20 = for AWG 18~24
99/14 = for AWG 16
if Phosphor Bronze (on request):
99/27P = for AWG 22~28
99/20P = for AWG 18~24
99/14P = for AWG 16

Execution

P = with panel Clip lock
PN = without panel Clip lock

for details see above dwg's

Plating

99 = Tin (leadfree)

other platings on request

4.20mm Wire to Board "Blind Mate" Crimp Contact "Power Connectors"



BM - Type Male Header Dual Row fully shrouded with polarity protection

-THT- straight (top entry)

Order Code: **PCS-2xx-BM420-99**

-THT- right angle (side entry)

Order Code: **PCR-2xx-BM420-99**

BF - & BSC - Type Female Dual Row with polarity protection

-THT- straight

Order Code: **PCS-2xx-BF420-99**

Dual Row Female Plug Housing panel mount Clip lock Type

Order Code: **PCF-2xx-BSC420** Contact: **PCF-999/xxX-P420-99**

BC - Type Male Plug Housing Dual Row panel mount Clip lock Type

mate with PCF-2xx-P420

Order Code: **PCM-2xx-BC420**

Male Contact

Order Code: **PCM-999/xxX-P420-99**

Specifications			
Current rating	pls. see box page 133-1	Voltage rating	600 V AC max.
Insulation resistance	1000 MΩ min.	Withstanding voltage	1500 V AC
Contact resistance	20 mΩ max.	Operating temp.	-40°C to +105°C
		Contact material	Copper alloy
		Insulator material	PA66 UL 94V-2
		PCB / Panel thickness	1.80 mm max.

How to order

PC X - x xx - X 420 - 99

Type	Rows	Nbr of Contacts	Execution	Plating
F = Female M = Male R = Right angle S = Straight	2 = dual row <i>if Crimp Contact:</i> 9	02 - 24 = BC, BF, BM & BSC -Type <i>if Crimp Contact: (MOQ: 5K / reel)</i> <i>if Brass (standard):</i> 99/27 = for AWG 22~28 99/20 = for AWG 18~24 99/14 = for AWG 16 <i>if Phosphor Bronze (on request):</i> 99/27P = for AWG 22~28 99/20P = for AWG 18~24 99/14P = for AWG 16	BC = Male Plug Housing BF = THT Female BM = THT Male P = Male Contact for details see above dwg's	99 = Tin (leadfree) other platings on request

F - Type "Friction Lock" Single Row

Female Plug

Order Code Housing: **PCF-1xx-F508** Contact: **PCF-999/20-F508-99**

-THT- male header straight & right angle

Order Code straight: **PCS-1xx-F508-99** right angle: **PCR-1xx-F508-99**

Disc Drive Power Connector

P - Type 2, 3 & 4 Crimp Contact - Female Plug

Order Code Housing: **PCF-1xx-P508**
Contact: **PCF-999/16-P508-99** or **PCF-999/19-P508-99**

I - Type IDC - Female Plug (AWG 18~20)

Order Code with standard Cover: **PCF-104-I508-99**
with Type "C" Cover: **PCF-104-I508-99/C**

C - Type 2, 3 & 4 Crimp Contact - Male Plug

Order Code Housing: **PCM-1xx-C508** Contact: **PCM-999/19-C508-99**

Specifications

Current rating	7 A	Voltage rating	250 V AC max.	Contact material	Copper Alloy
Insulation resistance	1000 MΩ min.	Withstanding voltage	1500 V AC	Insulator material	PA66 UL 94V-2
Contact resistance	20 mΩ max.	Operating temperature	-40°C to +105°C	PCB thickness	1.60 mm

How to order

PC X - x xx - X 508 - 99

<p>Type</p> <p>F = Female R = R/A Male S = Straight Male M = Male contact & Header</p>	<p>Rows</p> <p>1 = single row</p> <p><i>if Crimp Contact:</i> 9</p>	<p>Nbr of Contacts</p> <p>02 - 10 = F - Type 02, 03 & 04 = P & C - Type 04 = I - Type</p> <p><i>if Crimp Contact:</i> 99/20 = for AWG 18~24 99/19 = for AWG 18~22 99/16 = for AWG 16~20</p> <p>MOQ: P- & C-Type = 6K / reel F - Type = 7K / reel</p>	<p>Execution</p> <p>F = THT & Plug P = Plug I = Plug C = Plug</p> <p>for details see above dwg's</p>	<p>Plating</p> <p>99 = Tin <i>(leadfree)</i></p> <p>other platings on request</p>
---	--	---	---	---

5.08mm Power Connectors Disk Drive Power Connection System



4 Contact Male - Through Board Solder Types

Straight "T" type

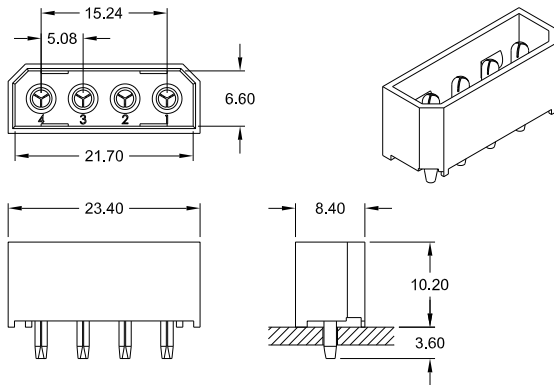

Order Code: **PCS-104-T508-99**

Right angle "T" type

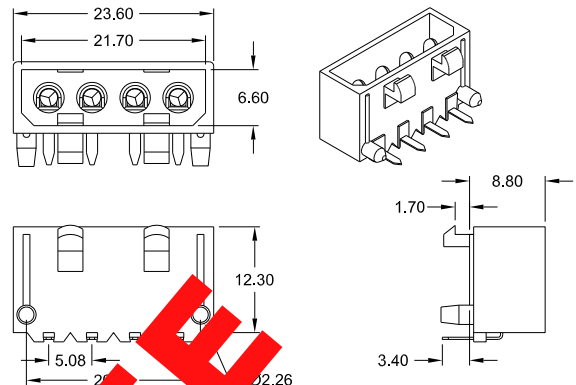

Order Code: **PCR-104-T508-99**

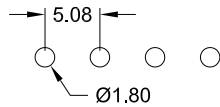

PCB Hole Layout

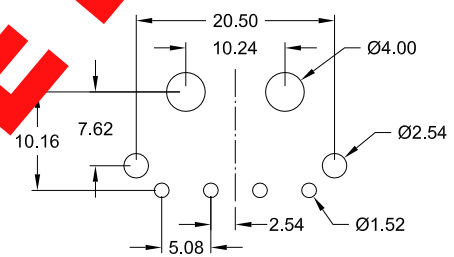

PCB Hole Layout

OBSOLETE

SPECIFICATIONS

Current rating	7 A	Contact resistance	20 mΩ max.	Contact material	Copper alloy
Insulator resistance	1000 MΩ min.	Withstanding voltage	1500 V AC	Insulator material	PA UL 94 V-2
Voltage rating	250 V AC max.	Operating temp.	-25°C to +90°C	PCB Thickness	1.60 mm (.063")

How to order

PC X - 104 - T 508 - 99

Type	
R	= right angle type
S	= straight type

Plating	
99	= Tin <i>(leadfree)</i>



P - Type "Quick Lock" Single Row

<p>Plug Housing (load with Female Contact)</p> <p>Order Code Housing: PCF-1xx-P635/X</p>	<p>Clutch Housing (load with Male Contact)</p> <p>Order Code Housing: PCC-1xx-P635/X</p> <p style="font-size: small;">For Panel cut out and thickness dimension please order product drawing</p>
--	--

<p>Female Contact</p> <p>Order Code Contact: PCF-999/xx-P635-99 MOQ: 10K / reel</p>	<p>Male Contact</p> <p>Order Code Contact: PCM-999X/xx-P635-99 MOQ: 10K / reel</p>
--	---

Fully Shrouded Header

<p>-THT- Male & Female straight (top entry)</p> <p>Option Contact Type Order Code</p> <p>male: PCS-1xx-PM635-99</p> <p>female: PCS-1xx-PF635-99</p>	<p>-THT- Male & Female right angle (top entry) with mounting ears</p> <p>Option Contact Type Order Code</p> <p>male: PCR-1xx-PWM635-99</p> <p>female: PCR-1xx-PWF635-99</p>
--	--

Specifications

Current rating	13 A (5-10 pos. 11 A)	Voltage rating	600 V AC max.	Contact material	Copper Alloy
Insulation resistance	1000 MΩ min.	Withstanding voltage	1000 V AC	Insulator material	PA66 UL 94V-0 & V-2
Contact resistance	20 mΩ max.	Operating temperature	-55°C to +105°C	PCB thickness	1.60mm

How to order

PC X - x xx - X 635 - 99 / X

Type	Rows	Nbr of Contacts	Execution	Plating	Color Option
C = Clutch F = Female M = Male R = Right angle S = Straight	1 = single row <i>if Crimp Contact:</i> 9	02 - 10 = P, PM, PF, PWM PWF - Execution <i>if Crimp Contact:</i> PCM-Type for 2 to 5 Position: 99L/10 = for AWG 12~14 99L/16 = for AWG 16~20 99L/19 = for AWG 18~22 PCM-Type for 6 to 10 Position: PCF-Type for 2 to 10 Position: 99/10 = for AWG 12~14 99/16 = for AWG 16~20 99/19 = for AWG 18~22	P = P - Type PM = P - Type male PF = P - Type female <i>PM & PF are with polarizing pin available. Pls. ask for separate datasheet.</i> PWM = PW - Type male PWF = PW - Type female for details see above dwg's	99 = Tin (leadfree) other platings on request	N = nature (UL 94V-2) W = white (UL 94V-0)



P - Type "Quick Lock" Triple Row

<p>Plug Housing (load with Female Contact)</p> <p>Order Code Housing: PCF-3xx-P635/X</p>	<p>Clutch Housing (load with Male Contact)</p> <p>Order Code Housing: PCC-3xx-P635/X</p> <p>For Panel cut out and thickness dimension please order product drawing</p>
<p>Female Contact</p> <p>Order Code: PCF-999/xx-P635-99 MOQ: 10K / reel</p>	<p>Male Contact</p> <p>Order Code: PCM-999/xx-P635-99 MOQ: 10K / reel</p>

Fully Shrouded Header

<p>-THT- Female straight (top entry)</p> <p>Order Code: PCS-3xx-PF635-99/X</p>	<p>-THT- Male straight (top entry)</p> <p>Order Code: PCS-3xx-PM635-99/X</p>
--	--

Specifications

Current rating	13 A (5-10 pos. 11 A)	Voltage rating	600 V AC max.	Contact material	Copper Alloy
Insulation resistance	1000 MΩ min.	Withstanding voltage	1000 V AC	Insulator material	PA66 UL 94V-0 & V-2
Contact resistance	20 mΩ max.	Operating temperature	-55°C to +105°C	PCB thickness	1.60mm

How to order

PC X - x xx - X 635 - 99 / X

<p>Type</p> <p>C = Clutch F = Female M = Male S = Straight</p>	<p>Rows</p> <p>3 = triple row</p> <p>if Crimp Contact: 9</p>	<p>Nbr of Contacts</p> <p>P, PF & PM – Execution: 06, 09, 12 & 15</p> <p>if Crimp Contact: 99/10 = for AWG 12~14 99/16 = for AWG 16~20 99/19 = for AWG 18~22</p>	<p>Execution</p> <p>P = P - Type PM = P - Type male PF = P - Type female</p> <p>for details see above dwg's</p>	<p>Plating</p> <p>99 = Tin (leadfree)</p> <p>other platings on request</p>	<p>Color Option</p> <p>N = nature (UL 94V-2) W = white (UL 94V-0)</p> <p>PF & PM Execution if polarizing is requested: NP = nature (UL 94V-2) WP = white (UL 94V-0)</p>
---	---	---	---	--	--

Other products from E-tec

Please contact your closest sales office for further information.



Flex Cable Test Units



DIMM Sockets



DIP Switch

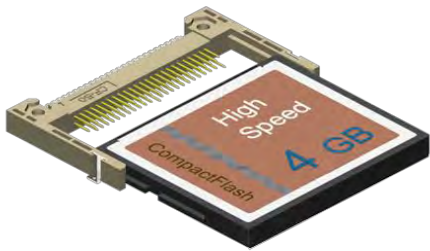

Compact Flash Connector

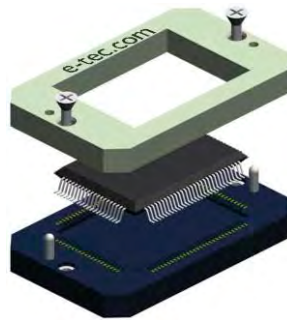

Gullwing Chip Sockets



USB & IEEE 1394 Connectors

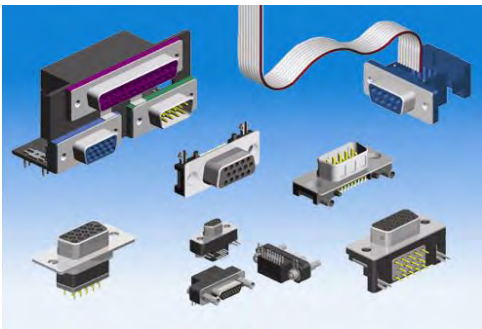

D-Sub Connectors

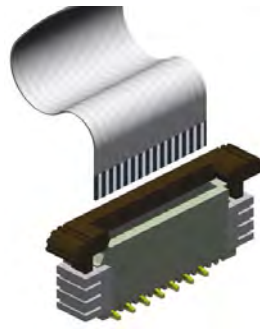

Flex Cable Connectors



HDMI Connectors



Probe Pin & Probe Pin Connectors



Test Sockets & Adapters



Multi Media Card Connectors

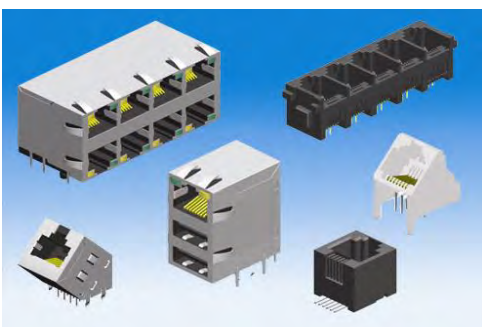

Modular Plugs & Jacks

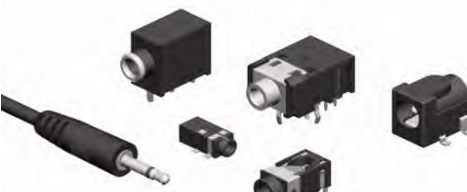

Phono - & DC - Power Connectors



RF - Connectors

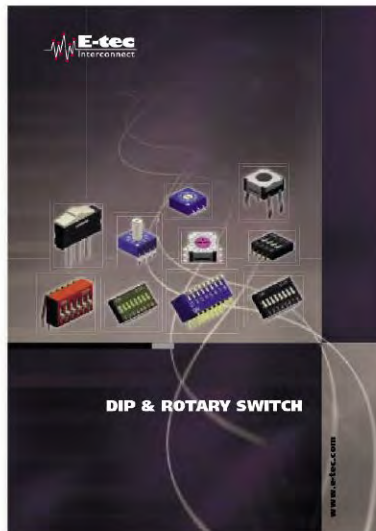
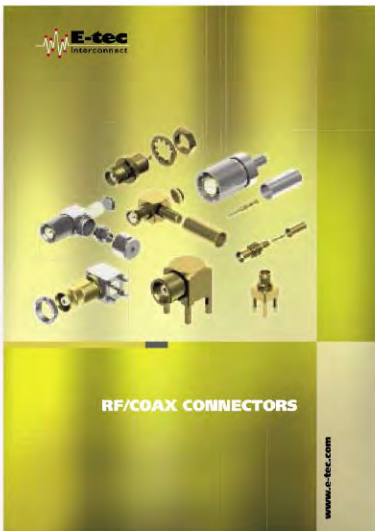

The E-tec Group

International Sales Headquarter and Factory

Switzerland **E-tec Interconnect AG**
Friedhofstrasse 1
CH-2543 Lengnau b.Biel
Phone: +41 (0) 32 654 15 50
Fax: +41 (0) 32 652 26 93
E-mail: info@e-tec.com
Web: www.e-tec.com

Factory

Taiwan **E-tec Interconnect Asia Ltd.**
7F, No. 69, Sec.2, Guangfu Rd.
Sanchong Dist., New Taipei City
24158 Taiwan R.O.C.
Phone: +886 2 2999 2726
Fax: +886 2 2999 5255
E-mail: info@e-tec.asia
Web: www.e-tec-asia.com.tw

Related Sales Headquarters

Germany **EMC**
Electro mechanical components GmbH
Deningerstrasse 4a
D-65510 Idstein
Phone: +49 (0) 6126 93 95-0
Fax: +49 (0) 6126 93 95-72
E-mail: info@emc.de
Web: www.emc.de

England **E-tec Interconnect (UK) Ltd**
Units A5 & A6 Decimus Park
Kingstanding Way
Tunbridge Wells
Kent TN2 3GP
Phone: +44 (0) 18 92 53 02 60
Fax: +44 (0) 18 92 51 55 60
E-mail: info@e-tec.co.uk
Web: www.e-tec.co.uk

France **Steliau Technology**
41-43, rue Périer
92120 Montrouge
Phone: +33 (0) 1 55 58 04 04
Fax: +33 (0) 1 55 58 04 00
e-mail: contact@steliau-technology.com
Web: www.steliau-technology.com

USA / Canada **E-tec Interconnect USA**
18615 Arguello Ave
Morgan Hill, CA 95037
Phone: +1 408 778 2800
Fax: +1 408 823 7724
E-mail: info-us@e-tec.com
Web: www.e-tec.us.com

TopLine Corporation
95 Highway 22 W.
Milledgeville, GA 31061
Phone: +1 478 451 5000
Fax: +1 478 451 3000
E-mail: sales@TopLine.tv
Web: www.TopLine.tv

India **E-tec Interconnect AG India**
#1/1, Sai Towers, RV Road,
Diagonally OPP to Kamath Hotel
Basvanagudi, BANGALORE - 560004
Phone: +91 (0) 9663112596
E-mail: info.india@e-tec.com
Web: www.e-tec.com

Your authorised distributor: